

Research Needs for Fusion-Fission Hybrid Systems

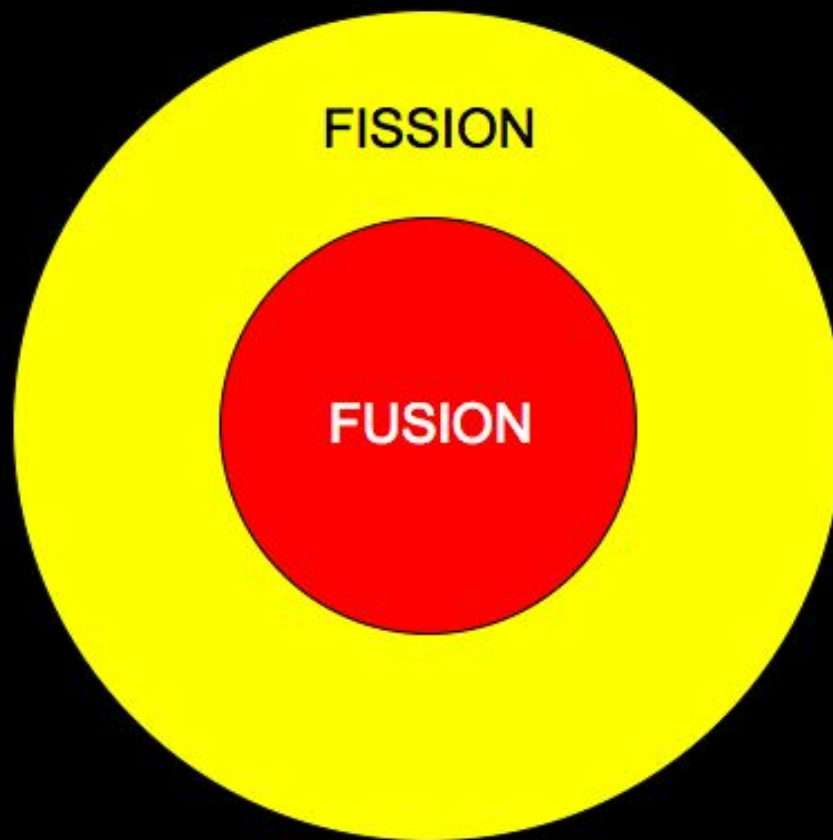

*Report of the Research Needs Workshop (ReNeW)
Gaithersburg, Maryland Sept 30 – Oct 2, 2009*



Disclaimer

This report was prepared as an account of work sponsored by agencies of the United States government. Neither the United States government nor any agency thereof, any of their employees, any of their contractors and contractors' employees, or subcontractors or subcontractors' employees, makes any warranty, express or implied, or assumes any legal liability or responsibility for the accuracy, completeness, or any third party's use of the results of such use of any information, apparatus, product, or process disclosed, or represents that its use would not infringe privately owned rights. Reference herein to any specific commercial product, process, or service by trade name, trademark, manufacturer, or otherwise, does not necessarily constitute or imply its endorsement, recommendation, or favoring by the United States government or any agency thereof or its contractors or subcontractors. The views and opinions of the authors expressed herein do not necessarily state or reflect those of the United States government or any agency thereof.

Research Needs for Fusion-Fission Hybrids

Report of the Research Needs Workshop (ReNeW)

Chair: JEFFREY FREIDBERG, MIT

Vice Chair: PHILLIP FINCK, Idaho National Laboratory

DoE: CURT BOLTON, Fusion Energy Sciences - DoE

Subcommittee Chairs: ROBERT HILL, Argonne National Laboratory

ALBERT MACHIELS, Electric Power Research Institute

NEIL MORLEY, University of California, Los Angeles

WALTER SADOWSKI, University of Maryland

JOHN SHEFFIELD, University of Tennessee

HAROLD WEITZNER, New York University

DoE Contacts: ROSTOM DAGAZIAN, FES

FRANK GOLDNER, NE

KIRK LEVEDAHL, NNSA

JOHN MANDREKAS, FES

ALBERT OPDENAKER, FES

RICHARD STARK, NE

FRANCIS THIO, FES

Table of Contents

Preface.....	5
Executive Summary	7
Chapter 1 — Introduction.....	11
Chapter 2 — The Fusion-Fission Hybrid Primer	15
Chapter 3 — Fusion-Fission Fuel Cycles.....	29
Chapter 4 — Fusion-Fission Hybrid Drivers	39
Chapter 5 — Blanket and Nuclear Technology	100
Chapter 6 — Alternative Approaches.....	120
Chapter 7 — International Hybrid Programs	136
Chapter 8 — Report of Skeptics Panel	151
Chapter 9 — High-Level Findings and Research Needs.....	158
Chapter 10 — Technical Findings and Research Needs	163
Appendix A — DoE Charge Letter	173
Appendix B — Subcommittee Chairs and Members.....	176
Appendix C — Previous Studies of Sustainability of the Nuclear Fuel Cycle	183

Preface

The U.S. Department of Energy (DOE) sponsored a workshop from September 30 to October 2, 2009, in Gaithersburg, Maryland, focusing on fusion-fission hybrid reactors. The participating divisions of DOE were the Office of Science's Office of Fusion Energy Science (OFES), the Office of Nuclear Energy (NE), and the National Nuclear Security Administration (NNSA). In attendance were about 100 scientists and engineers from the fusion and fission communities. The charge letter to the workshop organizers and a list of subcommittee chairs and members are given in Appendices A and B.

To prepare for the workshop, a number of subcommittees were established to review the existing literature and to take the lead in writing the corresponding chapters appearing in the report. In general there was input to all chapters from all members of the workshop. However, in the end it was the chair of each subcommittee who was responsible for the content of the corresponding chapter. In the text under each chapter heading are listed the members of that subcommittee, with the chair listed first. The titles of these chapters are as follows:

Chapter 1	Introduction
Chapter 2	The Fusion-Fission Hybrid Primer
Chapter 3	Fusion-Fission Fuel Cycles
Chapter 4	Fusion-Fission Hybrid Drivers
Chapter 5	Blanket and Nuclear Technology
Chapter 6	Alternative Approaches
Chapter 7	International Hybrid Programs
Chapter 8	Report of the Skeptics Panel
Chapter 9	High-Level Findings and Research Needs (whole workshop involved)
Chapter 10	Technical Findings and Research Needs (whole workshop involved)

It is worth noting the appointment of a subcommittee of skeptics responsible for Chapter 8. This subcommittee was formed because the original impetus for the workshop grew out of the enthusiasm of fusion-fission hybrid advocates, mainly from the fusion community. The organizers thus felt that a committee of "skeptics" would offer some balance to the workshop. It should be emphasized that in the final report the skeptics had final editorial control over their chapter, and they do not agree with many of the statements made in other chapters, particularly those with major input from hybrid advocates. Likewise, many if not all of the advocates do not agree with the comments made by the skeptics. The organizers felt that it was best to have the differing views stated separately, recognizing that neither group endorsed the conclusions of the other. This was viewed as more desirable than watering down all the conclusions in order to reach consensus.

Altogether, the hybrid-related activity took place over a five-month period from June through October 2009. During this time numerous emails were exchanged and many conference calls took place. The culmination of this activity was the workshop in Gaithersburg, Maryland. The product of these deliberations is the report contained herein.

Executive Summary

Largely in anticipation of a possible nuclear renaissance, there has been an enthusiastic renewal of interest in the fusion-fission hybrid concept, driven primarily by some members of the fusion community. A fusion-fission hybrid consists of a neutron-producing fusion core surrounded by a fission blanket. Hybrids are of interest because of their potential to address the main long-term sustainability issues related to nuclear power: fuel supply, energy production, and waste management.

As a result of this renewed interest, the U.S. Department of Energy (DOE), with the participation of the Office of Fusion Energy Sciences (OFES), Office of Nuclear Energy (NE), and National Nuclear Security Administration (NNSA), organized a three-day workshop in Gaithersburg, Maryland, from September 30 through October 2, 2009. Participants identified several goals. At the highest level, it was recognized that DOE does not currently support any R&D in the area of fusion-fission hybrids. The question to be addressed was whether or not hybrids offer sufficient promise to motivate DOE to initiate an R&D program in this area. At the next level, the workshop participants were asked to define the research needs and resources required to move the fusion-fission concept forward.

The answer to the high-level question was given in two ways. On the one hand, when viewed as a standalone concept, the fusion-fission hybrid does indeed offer the promise of being able to address the sustainability issues associated with conventional nuclear power. On the other hand, when participants were asked whether these hybrid solutions are potentially more attractive than contemplated pure fission solutions (that is, fast burners and fast breeders), there was general consensus that this question could not be quantitatively answered based on the known technical information. Pure fission solutions are based largely on existing both fusion and nuclear technology, thereby prohibiting a fair side-by-side comparison.

Another important issue addressed at the conference was the time scale on which long-term sustainability issues must be solved. There was a wide diversity of opinion and no consensus was possible. One group, primarily composed of members of the fission community, argued that the present strategies with respect to waste management (on-site storage) and fuel supply (from natural uranium) would suffice for at least 50 years, with the main short-term problem being the economics of light water reactors (LWRs). Many from the fusion community believed that the problems, particularly waste management, were of a more urgent nature and that we needed to address them sooner rather than later.

There was rigorous debate on all the issues before, during, and after the workshop. Based on this debate, the workshop participants developed a set of high-level Findings and Research Needs and a companion set of Technical Findings and Research Needs. In the context of the Executive Summary it is sufficient to focus on the high-level findings, which are summarized below.

High-Level Findings

1. **The potential role of fusion-fission hybrids:** A fusion-fission hybrid could contribute to all components of nuclear power — fuel supply, electricity production, and waste management.
2. **Ideas put forth by hybrid proponents:** The idea of the fusion-fission hybrid is many decades old. Several ideas, both new and revisited, have been investigated by hybrid proponents. These ideas appear to have attractive features, but they require various levels of advances in plasma science and fusion and nuclear technology:
 - a. **A waste transmuter based on the leading magnetic fusion and fast burner reactor technologies:** One tokamak-based proposal combines ITER physics and technology (the leading magnetic fusion technology) with sodium-cooled fast burner reactor technology, plus the associated fuel reprocessing/refabrication technologies (the leading related burner reactor technologies). By building on the most advanced systems in both fusion and fission, this hybrid concept would require the least amount of advanced technology development. ITER is designed to achieve a duty factor of 25% for burn periods greater than 10 minutes, and to operate continuously for periods of 12 consecutive days. However, it is designed to operate only about 4% of the cumulative time over its 14 year DT operation period. This performance level is well below the 50-75% required availability for a hybrid system, so significant fusion technology reliability advances would still be required (as for any fusion concept), and the technology to integrate the two systems (such as dealing with a liquid metal in a magnetic field) would need to be developed. A reprocessing fuel cycle was proposed in which the actinides from LWR spent fuel were burned to greater than 90% in the hybrid
 - b. **A waste transmuter with a removable fusion core:** This is a spherical tokamak-based concept that employs a compact replaceable fusion core that can be extracted as a single unit from the fission reactor. The goal is to minimize the electromagnetic and mechanical coupling between the fusion and fission systems. Maintenance and repairs would be simplified by periodically removing the fusion core to a remote bay and replacing it with another in the fission reactor. Also, to minimize magnetohydrodynamic (MHD) problems, the fission blanket is located outside the toroidal magnetic field coils. The fuel cycle of interest, which could be used by other hybrid concepts as well, uses a fusion-enhanced version of the two-tier process. Actinides are first reprocessed from spent fuel, then 75% burned in an intermediate-stage LWR using inert matrix fuel (IMF) and finally burned in a hybrid, thereby providing a high support ratio. However, a new IMF would need to be developed, and a full systems analysis is required to assess the overall economics, including the contributions of the intermediate-stage IMF

LWRs. Probably one additional physics development step is required before an ITER-equivalent neutron source prototype could be built.

- c. Once-through burn-and-bury energy producers:** A very deep-burn fuel cycle based on laser fusion has been proposed, in which nuclear fuel is almost completely burned. The initial fuel does not require enrichment. Perhaps even more important, the deep burn has the attractive feature that, if it is successful, no reprocessing would be required. However, a very deep-burn fuel form needs to be developed, and almost the full capabilities of pure fusion systems would be required. Also, high-power, high rep-rate lasers need to be developed to produce high average power and the first wall would need to endure the same fusion neutron fluence as a pure fusion system.
 - d. Efficient LWR fuel breeders:** These breeders are concepts in which fissile fuel is produced in a flowing liquid blanket. The fissile fuel is removed on line in order to suppress its subsequent fission in the hybrid system. An efficient fuel breeder for LWRs has the advantage of enabling a long-term sustainable fleet of LWRs requiring relatively few hybrids for fuel production. However, in addition to fusion technology developments, this concept requires the development of continuously flowing fuel systems. The use of hybrids to produce fissile fuel is applicable to both magnetic fusion energy (MFE) and inertial fusion energy (IFE) systems. It was studied in great detail during the 1980s by MFE mirror advocates. The mirror configuration may need to be revisited because of recent progress in plasma performance which was obtained in the international fusion program.
- 3. Repositories:** Any waste management strategy using either pure fission technology or fusion-fission hybrid technology will still require a long-term geological repository for the final remaining long-lived waste.
 - 4. A political problem:** Although technologically deployable long-term solutions for fuel and waste management may not be needed for half a century, there is a short-term political problem facing the nation. With work on Yucca Mountain halted, there is no perceived progress on addressing the waste management problem on any time scale.
 - 5. Economic comparison of pure fission vs. fusion-fission hybrid solutions:** There was general consensus that a hybrid capable of producing a certain amount of electric power would be noticeably more expensive than an LWR producing the same amount of power. Economic comparisons thus have to be made on an overall systems basis. For example, we must ask what is the overall cost of a group of LWRs plus necessary hybrids versus a combination of LWRs plus perhaps a larger number of fast reactors, with each system producing the same amount of power and reducing the waste to the same level.
 - 6. An intermediate step to pure fusion electricity:** Advocates suggest that a fusion-fission hybrid can be developed on a shorter time scale than for pure fusion

electricity because the required plasma physics and some technology requirements are substantially reduced. Some of the panels and also the skeptics argued that some technology may be more complicated in a hybrid because of the integration of fusion and fission technologies. Perhaps more important, the pace of development will be dominated by engineering and technology and not by plasma physics. The skeptics plus some panel members believe that the time scales for development will be comparable for both.

7. **The international fusion-fission hybrid program:** Some of the experts at the workshop expressed concerns about the slow pace of development of fusion-fission hybrids in the U.S. program. However, such concerns were not shared by our international colleagues. Indeed, several countries, including the Russian Federation, South Korea, and China, are considering the option to develop neutron sources as a first step toward building hybrids.
8. **Proliferation:** Hybrids produce significant quantities of fissile materials, generally not retained in individually accountable fuel rods, and hence raise significant proliferation concerns.

High-Level Research Needs

1. **Comparison between fission-based and hybrid solutions:** The first step that needs to be carried out is a side-by-side systems analysis comparison of proposed pure fission and fusion-fission hybrid solutions to the problems of waste management, fuel supply, and electricity production. The basic ground rules are that comparable assumptions (regarding material properties, fuel forms, and so forth) must be used for each design
2. **Fusion engineering and technology:** There appeared to be widespread consensus that neither pure fusion nor fusion-fission hybrids could be developed, even in 50 years, unless the fusion engineering and technology programs were restarted in the DOE Office of Fusion Energy Sciences Program (OFES). Of particular concern was the need for an expanded blanket and materials research program. Without strong fusion engineering and technology programs, the United States will continue to be unable to have a defined timetable for a fusion power plant and thus will fall further and further behind our international colleagues — they will be the leaders and we the followers.

Chapter 1

Introduction

Jeffrey Freidberg (Chair), Phillip Finck (Co-Chair), Steve Dean, Andrew Kadak, Massimo Salvatores, Phil Sharpe, Bill Stacey, Don Steiner, Vincent Tang, Roald Wigeland

A fusion-fission hybrid is defined as a subcritical nuclear reactor consisting of a fusion core surrounded by a fission blanket. The fusion core provides an independent source of neutrons, which allows the fission blanket to operate subcritically.

The fundamental mission of the fusion-fission hybrid is to address an important national and worldwide problem — namely, converting nuclear power from its current deployment path, which is sustainable only for perhaps another 50 to 100 years, to one that is sustainable for millennia. A realistic expectation of long-term sustainability might also motivate a more rapid expansion of conventional nuclear power to help meet our energy needs in the near-to-mid term.

Many studies over the past few decades addressing the sustainability issue have focused on pure fission-based solutions, specifically fast breeders and fast burners (see Appendix C). Indeed, many members of the fission community present at the workshop believe that such solutions can adequately address the sustainability issues when the need arises and are much further developed than other alternatives such as accelerator-driven hybrids or fusion-fission hybrids. In contrast, hybrid advocates suggest that the extra design freedom and fuel cycle flexibility provided by an independent source of neutrons would be beneficial, and perhaps necessary, to achieving the practical sustainability of nuclear power.

The main applications of hybrids discussed in this report are: (1) nuclear waste management by means of burning long-lived radioactive waste products, (2) the simultaneous production of energy and management of new or existing nuclear waste by deep-burn fuel cycles, and (3) the breeding of new fissile fuel by substantially increasing the utilization efficiency of U-238, the dominant component of both natural uranium and spent nuclear fuel, or alternatively, converting to a Th-232 fuel cycle.

The purpose of the workshop was to review the current status of hybrid research and revisit the potential for such devices to contribute in a substantial way to the production of carbon-free nuclear energy in the short-, mid-, and long-term future. DOE currently does not sponsor an ongoing research and development program in the area of hybrids, which presented the following practical challenge to the workshop participants:

Is the current status and future potential of fusion-fission hybrids sufficiently promising to provide motivation for DOE to initiate a new R&D program in this area?

A logical way to address the question is to first describe the current contributions of nuclear power to our energy security, including a description of the issues that may affect

the future use of this technology. With these issues defined it then becomes easier to understand those areas in which hybrids might contribute.

Current Status of Nuclear Power

The United States has a fleet of about 100 nuclear reactors that provides approximately 20% of its electricity. These are light water reactors (LWRs) that use enriched uranium as fuel. The reactors have a remarkable safety record, are not particularly difficult to maintain, and have an impressive capacity factor — they are operating at full capacity about 90% of the time. The future need in the United States and the world for a large increase in carbon-free base load electricity implies that nuclear power may be called upon to play a significantly expanded role in our energy portfolio.

What, then, are the issues? There are three that must be addressed. First, and most important from the industrial point of view, is economics. The capital cost of an LWR is high compared to that of a coal or natural gas plant, although its fuel supply is much less expensive and no CO₂ is produced. Even so, the fission industry is continually making technological improvements on the design of LWRs to lower the capital costs. At present, the overnight capital costs are high but still probably acceptable from an economic viewpoint. The real difficulty is obtaining financing. Investors are legitimately concerned about non-technically-generated delays, which can greatly increase the actual capital cost over that of the overnight cost. Accordingly, investors are seeking loan guarantees from the government to reduce this risk.

The second problem facing nuclear power is waste management. This is the nearest-term and most important problem faced by the U.S. government, because by law the government has the responsibility for disposing the nuclear waste generated by commercial nuclear power plants, and it is far behind schedule with no clear strategy for the future. The longstanding idea of permanently burying waste in a geological repository has been called into question with the administration's plan to stop work on the Yucca Mountain repository. Other fission-based waste disposal concepts, such as the fast burner, are ready for prototyping today and could be commercially deployed within 20 to 30 years, but these concepts invariably involve the chemical reprocessing of spent fuel. At present the United States does not do reprocessing because it is not viable economically. It also leads to an increased risk of proliferation because of the possibility of separating and recovering plutonium.

What, then, does the country now do with its spent fuel? At present spent fuel is stored on site at nuclear power plants in liquid pools and dry cask storage. This practice has safely and satisfactorily taken place for 50 years and can probably continue for at least another 50 years. However, this strategy is not sustainable — the country eventually needs to face up to the disposal of the long-lived components of the waste. On the one hand, the problem is not urgent, since we have a 50-year cushion for developing a strategy. On the other hand, some of the proposed solutions to the problem require multi-decade R&D programs in order to be ready when the need arises.

The third issue facing the future of nuclear power is fuel supply. At present, the uranium required to power light water reactors is obtained through mining. Reserve estimates indicate that there will be sufficient natural uranium available at competitive prices for about 50 to 100 years, even with a substantial increase in the number of nuclear power plants in the United States and the world. Still, nuclear power has the potential to become a truly sustainable source of carbon-free energy for thousands of years if the existing fuels are utilized more efficiently (or if new supplies can be exploited economically). Fission research has suggested various ways to address this problem; for instance, by using fast breeder reactors, which are in many respects ready today, or by harvesting uranium from the ocean, a relatively costly endeavor at present. As with waste management, the fuel problem is not urgent at this time. Here, too, a multi-decade R&D program is needed so that these solutions will be ready when they are needed.

The Potential Role of Hybrids

The existing strategies for waste management, energy production, and fuel supply represent an unsustainable way forward. The country needs well-developed options for the future that will help move nuclear power onto a path that could be sustained for thousands of years. Here is where the hybrid may enter the picture.

The fusion-fission hybrid has the potential to make a contribution to waste management, energy production, and fuel supply along a path of long-term sustainability.

It is important to emphasize that other alternatives have been proposed to achieve sustainability, such as fast breeders, fast burners, accelerator-driven hybrids, and repositories of various types. These alternatives are each far more developed than the fusion-fission hybrid, but still require additional R&D to achieve a status ready for commercialization or, perhaps, a different economic situation that would make the use of such approaches attractive. None has as yet been implemented because of the lack of an immediate need, the requirement for further development, the cost of deployment, and in some cases a lack of political will. The fusion-fission hybrid concept offers one more way to achieve sustainability. In the end it must compete against the other alternatives with respect to safety, proliferation resistance, reliability, maintainability, availability, and, most importantly, economics in the context of an integrated nuclear energy system.

Remainder of the Report

A framework has now been established describing the goals of the workshop and the potential role of fusion-fission hybrids in developing sustainable nuclear energy. Chapter 2 describes the basic scientific principles of hybrids. How does the hybrid work and, at an overview level, how does it compare to the competition? Chapters 3 to 8 provide a reasonable level of technical detail about the various components of a hybrid reactor. These chapters will provide the foundation for the findings at the end of the report.

Chapter 2

The Fusion-Fission Hybrid Primer

Jeffrey Freidberg (Chair), Phillip Finck (Co-Chair), Steve Dean, Andrew Kadak,
Massimo Salvatores, Phil Sharpe, Bill Stacey, Don Steiner, Vincent Tang,
Roald Wigeland

2.1 Introduction

The purpose of Chapter 2 is to provide an introduction to fusion-fission hybrids. Included in the discussion are a description of the hybrid concept, its main applications, the main technical issues that must be resolved, and a brief comparison with other alternatives.

2.2 What Is a Fusion-Fission Hybrid?

2.2.1 Overview and Motivation

As stated in the Introduction, a fusion-fission hybrid is a subcritical nuclear reactor consisting of a fusion-powered core surrounded by a fission blanket. The fusion core serves as an independent external source of high-energy neutrons that allows the fission blanket to operate subcritically. See Figure 1 for several examples. The fission blanket makes use of fusion-generated neutrons for the following primary applications: (1) management of nuclear waste, (2) production of energy, and (3) generation of fissile fuel for light water reactors (LWRs). The waste management and fuel production applications also produce a large amount of nuclear energy, which plays a crucial role in the overall system economics. Various fusion concepts have been proposed to serve as the core, including both magnetic and inertial confinement systems.

The idea of the hybrid is not a new one. Its origins can be traced back about 50 years, and every decade or so the idea resurfaces¹⁻¹⁴. However, there has not yet been sufficient motivation to launch a serious experimental research program. The reasons are that in the past, hybrid applications were not considered to be critical to nuclear energy production and a hybrid reactor was viewed as a technologically complex, scientifically unproven, expensive facility because of the fusion core.

The situation has now changed. Many energy experts agree that nuclear power is a realistic way to achieve a large expansion of carbon-free, GWe-level, base-load electricity worldwide on a rapid time scale. Renewables, for all their advantages, cannot meet the demands for base-load electricity because of their intermittent nature. If nuclear power is to play an increasing role in the future U.S. energy portfolio, then at some point a transition must be made away from the current unsustainable strategy with respect to waste management and (in the longer term) fuel supply, to one that is truly sustainable. The fusion-fission hybrid represents one way to accomplish this mission without having to abandon well-established light water reactors or completely transition to a fleet of breeder reactors. Stated differently, waste management and fuel production, two hybrid applications that were not viewed as critical in the past, have risen in importance because

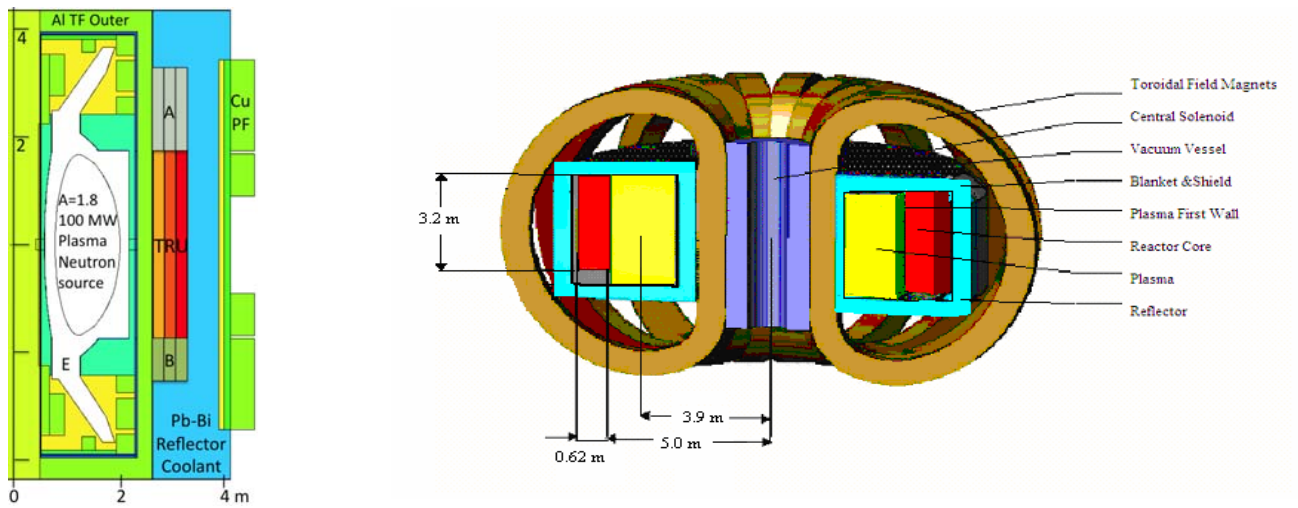

(a)

(b)

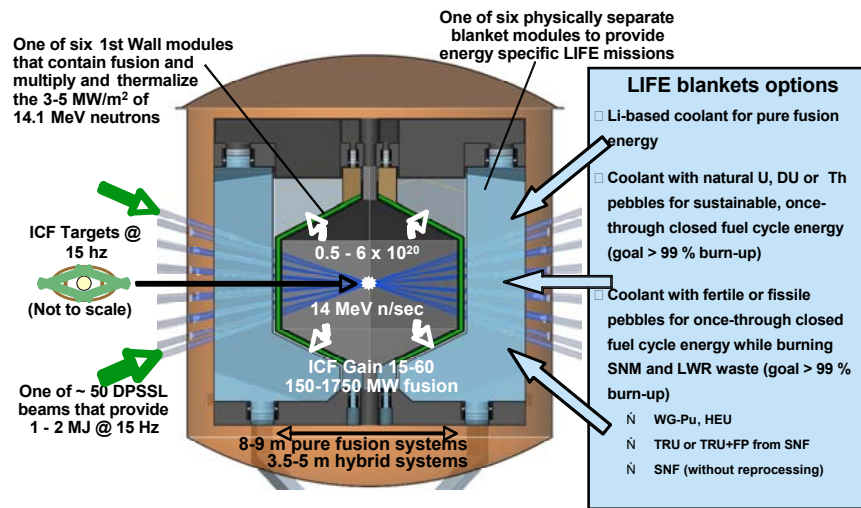

(c)

Figure 1. Recent proposed hybrid systems based on the following fusion drivers: (a) the spherical tokamak, (b) the standard tokamak, and (c) laser-driven inertial confinement.

of the anticipation of the nuclear renaissance and the new emphasis on minimizing carbon dioxide emissions. Furthermore, the past decade has seen a burst of scientific progress in plasma physics research, so that some of the earlier concerns about the unreliability of the fusion core have been significantly reduced.

A key question is whether the fusion-fission hybrid is the most desirable approach for achieving long-term nuclear power sustainability, compared to other alternatives.

2.2.2 Basic Nuclear Physics

In order to assess the attractiveness of the fusion-fission hybrid, it is useful to briefly review some basic nuclear physics.

Qualitatively, the primary scientific motivation for pursuing the hybrid approach has been to combine the neutron-rich characteristic of fusion systems with the energy-rich characteristic of fission systems. The hybrid approach can potentially relax both the plasma physics requirements for fusion core relative to pure fusion electricity and the neutron balance requirements for the fission blanket relative to fast burners and breeders.

Consequently, it is helpful to think of the fusion core, whether of magnetic or inertial origin, as simply a source of neutrons that are supplied to the surrounding fission blanket to help accomplish the application of interest, whatever it may be.

The primary fusion reaction of interest in a hybrid involves deuterium and tritium. At a temperature of about 15 keV these elements fuse, producing a 3.5 MeV alpha particle and a 14.1 MeV neutron. It is this neutron that is of interest to hybrids. It is worth noting that the blanket must breed tritium as well as accomplish its primary fission energy mission, since tritium is not available as a natural resource.

There are two different types of nuclear reactions that, depending upon design, can take place in the blanket: fission and capture. In a fission reaction a colliding neutron splits a heavy nucleus into smaller components and in the process releases a large amount of energy, typically 200 MeV. For some odd-mass-number isotopes, such as U-235, the desired energy of the incoming neutron is low, about 0.025 eV. These “thermal” neutrons are desirable for power-producing LWRs because they have a high probability of causing a fission reaction.

Neutrons with high energies, on the order of several MeV, can also cause fission reactions, with a higher relative probability (fission to capture ratio) but lower absolute probability than thermal neutrons although producing a higher average number of new neutrons per reaction. These “fast” neutrons are desirable for fissioning certain long-lived actinides¹ that cannot be efficiently split with thermal neutrons. While a large amount of energy is produced during fast neutron fission, the primary goal is to produce shorter-

¹ Here, actinides refer to radioactive elements with charge number $Z \geq 92$, some of which have very long half-lives and cannot be easily fissioned in a standard light water reactor. The elements plutonium, americium, neptunium, and curium are of the most concern in the management of nuclear waste.

lived byproducts, thereby reducing the amount of long-lived radioactive elements that need to be disposed of in a repository. The process of fast neutron fissioning for waste management applications is usually referred to as “transmutation.” It is worth noting that an independent supply of fast neutrons, coupled with the development of new fuel cladding technologies, might also enable the possibility of a prolonged deep burn, which reduces the net production of actinide nuclear waste. In this scenario the accompanying production of energy is essential for economic viability.

The second nuclear reaction of interest involves neutron capture. Here, a fertile element such as U-238 captures a neutron, producing a fissile element such as Pu-239. The plutonium is a desirable fuel that can be used to make energy either in LWRs or fission breeders and burners.

The proposed hybrid concepts potentially make use of each of these types of reactions. Ultimately economics, safety, environmental impact, proliferation resistance, technological readiness, and mission urgency will determine the competitiveness of hybrids in accomplishing any or all of the above missions.

2.2.3 A Closer Look at Potential Applications

To decide whether or not the hybrid is an attractive approach, one must carefully define the application. The reason is that in any hybrid application, as well as in fast breeders, fast burners, and accelerator-driven hybrids, there will be both fission and capture reactions that can contribute simultaneously (favorably or unfavorably) to waste management, fuel breeding, and energy production. It is important to define the primary mission to be able to make accurate comparisons with other alternatives.

Section 1.01 Waste Management

The issue of waste management must be considered very carefully. Three qualitatively different scenarios may be envisioned under the category of waste management. As a first scenario, consider Pu-239 to be an undesirable long-lived nuclear waste rather than a source of energy. In this case the plutonium and minor actinides must be chemically separated from the normal LWR spent fuel. It may also be desirable to separate the long-lived fission byproducts, such as Tc-99. This chemical separation is known as “reprocessing,” which, in general, is expensive and most agree will increase the risk of proliferation. The undesirable long-lived materials can then become part of the blanket in a hybrid transmuter. The high-energy fusion and fission neutrons provide an efficient means for transmuting the waste into short-lived elements. A variant of this scenario treats the plutonium as a desirable source of fuel, but doing so requires additional reprocessing to separate the Pu-239 from the minor actinides and long-lived fission byproducts. In this way the plutonium can be recycled under various options as a fuel while the remaining undesirable waste products can be disposed of in a hybrid transmuter.

As a second scenario, if one again views Pu-239 as a desirable fissile fuel, then a source of fusion neutrons can be used to substantially increase fuel burn-up compared to a critical reactor; that is, the fusion neutrons driving the subcritical fission blanket in the hybrid can supplement the fission neutrons to maintain the neutron chain reactor longer than in a critical reactor, for comparable enrichments. This is known as a “deep burn.” The result is that a much larger amount of actinide waste can be fissioned than in a critical reactor before the fuel must be removed. An added potential advantage is that with extremely deep burn it may be possible to employ a once-through “burn and bury” cycle that would eliminate the need for reprocessing and enrichment.

The third scenario is the case of a phase-out of nuclear power, where there still remains a large legacy of nuclear waste from commercial reactors and defense applications. The goal then is separation of plutonium, other minor actinides, and long-lived fission byproducts to be transmuted in a hybrid reactor. The residual long-lived waste from the hybrid reactor will be much smaller in mass and heat load, greatly reducing the burden on a geological repository with respect to volume, radiotoxicity, and heat load.

In the waste management modes of operation, large amounts of nuclear energy are always produced, which can be used to offset the costs of waste treatment.

Two final points are worth emphasizing. First, no matter how effective the waste management treatment may be, there will always remain some residual long-lived radioactive actinides and fission byproducts.

Consequently, any of the currently perceived waste management strategies will still require a permanent geological repository for sustainable nuclear energy.

An efficient waste management strategy can reduce but not eliminate the need for such repositories.

Second, waste management strategies often focus on the disposition of the long-lived radioactive actinides. Although these actinides determine the heat load after 100 years, hence determine the number of repositories needed to handle a given amount of waste, they do not always represent the most serious threat in terms of risk to the public through leaching into underground water tables.

Long-lived fission byproducts such as Tc-99 and I-129 present a greater risk to the water table because of their high solubility, compared to the actinides, in the surrounding repository soil. However, the actinides determine the heat load after 100 years, and hence the number of repositories needed.

A sustainable waste management strategy must account for these fission byproducts.

Section 1.02 Fuel Production

Although uranium fuel supply is deemed adequate for the next 50 to 100 years, eventually the uranium supply will become limited and more expensive for LWRs. The hybrid breeder can use depleted uranium from uranium enrichment, which is mostly U-238, to breed Pu-239 fuel for light water reactors. Millions of tons of depleted uranium are now in storage and are considered a low-level nuclear waste.

The fissile-fuel production application can also make use of thorium rather than uranium as the fertile fuel: Th-232 captures a neutron, producing U-233, which is an excellent fuel. However, most of the U.S. effort has thus far focused on U-238 producing Pu-239.

2.3 What Are the Main Issues Facing the Development of the Fusion-Fission Hybrid?

The goal here is to provide an overview of the main technical issues facing the hybrid, including plasma science and engineering, fusion technology, choice of fuel cycle, safety, economics, and time scale for development.

2.3.1 Plasma Science

A variety of magnetic and inertial confinement concepts are described in Chapter 4. Each has its own unique plasma-related science issues, and no concept has yet actually demonstrated the plasma performance necessary for use as a neutron source for a hybrid. However, in magnetic fusion the tokamak comes close. A large base of experimental data suggests that the required plasma performance could be achieved in a timely fashion. Furthermore, the expected performance of ITER should actually exceed many (but not all) of the requirements for a tokamak hybrid. Other non-tokamak magnetic fusion concepts would require at least one major intermediate-to-large new facility to demonstrate plasma performance, plus an ITER-level prototype before they could achieve credibility as commercial-scale neutron sources. Specific issues for tokamaks involve steady-state operation and control of macroscopic instabilities.

Non-tokamak concepts also require additional improvements in particle and energy transport, as well as in efficient methods to heat the plasma. For inertial fusion energy the situation is simpler. The results from the National Ignition Facility (NIF) should provide the necessary information regarding plasma science performance, including ignition and burn at moderate gain. This information would likely apply to any type of driver, but the problems associated with the reaction chamber, the cost of pellet production, and an increased pulsed rate of 10 per second compared to the present 1 to 3 per day are very challenging.

2.3.2 Plasma Engineering and Fusion Nuclear Technology

Existing fusion experiments have had little need to incorporate fusion nuclear technologies into facility construction and operation. Both the magnetic and inertial fusion programs have dealt with relatively small amounts of tritium and structural activation, at levels far below those that would be experienced in a hybrid.

Equally important magnetic fusion experiments to date have been operated in a pulsed mode and therefore have not demonstrated the steady-state or quasi-steady-state operation or reliability that will be required for a hybrid. High-performance inertial confinement experiments have not operated in the high-rep-rate mode required for energy applications.

For magnetic fusion, some R&D problems (such as superconducting magnets, plasma wall interactions, and remote handling) will be addressed at least partially in ITER, and these results can be directly applied to tokamak-based hybrids and perhaps some of the

non-tokamak alternates. Other R&D problems (such as tritium breeding and materials qualification) will not be fully addressed until a prototype hybrid is built. In the case of inertial confinement, development of repetitively pulsed drivers, target mass production, chamber evacuation between pulses, and tracking and delivery are all major engineering issues. Both magnetic and inertial confinement concepts must address the issues of reliability, availability, and maintainability required for commercial application.

2.3.3 Fuel Cycle

The choice of fuel cycle is a particularly important issue. Many options are available for both the waste management and fuel breeding applications. To help guide the choice of fuel cycle, the Gen IV initiative has defined, with a wide international consensus, a set of general goals for future systems in four broad areas: sustainability and waste minimization, enhanced economics, safety and reliability, and proliferation resistance and physical protection. These goals are quite difficult to satisfy simultaneously. Below are listed some of the important issues associated with the major fuel cycle options.

The current once-through fuel cycle used in LWRs requires resolution of the problem of where to locate geological repositories. If acceptable sites are located, one would then be able to address the currently open-ended nature of on-site waste storage. Still, because the once-through cycle utilizes only about 1% of the potential energy of the mined uranium, it will eventually (in about 50 to 100 years) lead to sustainability problems with respect to fuel supply.

A second strategy that minimizes the need for geological repository capacity involves the separation and subsequent irradiation of the actinides and the long-lived fission byproducts. This strategy is often called “partitioning and transmutation,” or P&T. The specific goal is to reduce the burden on geological disposal. When the nuclides mainly responsible for long-lived radiotoxicity — plutonium, the minor actinides, and a few fission byproducts — are first removed from the irradiated fuel (partitioned) and then transmuted, the remaining wastes have shorter half-lives and thus lose most of their long-term radiotoxicity. Moreover, in principle the P&T strategy allows a reduction of the radionuclide masses to be stored and of their associated residual heat; this reduction in turn decreases the volume and the cost of the repository.

The P&T strategy involves several challenges. First, partitioning requires reprocessing, which is complicated and expensive and raises proliferation risks. Also, while the PUREX reprocessing technique is available today, more R&D is needed to further develop advanced reprocessing techniques that would not produce pure plutonium, a desirable step toward reducing the risk of proliferation. Second, to avoid fuel supply problems in the future, the plutonium would have to be further separated from the waste into a proliferation-acceptable form that could be converted into useful fissile fuel. Third, as previously stated, P&T can reduce but not completely eliminate the need for a geological repository.

A third strategy being considered is the deep-burn fuel cycle. In general, deep-burn cycles allow the fuel to remain in the reactor for much longer times than in current LWRs. In the case of a fusion-fission hybrid, an independent source of neutrons maintains the reactivity of the fuel as new plutonium is produced and then burned without ever leaving the blanket. The result is an amount of actinide waste comparable to that from a standard LWR but produced over a much longer time — the actinide waste per year is substantially reduced, thereby lowering the burden on geological disposal. Deep-burn cycles can be repeated by periodic reprocessing at appropriate times.

The extreme limit of deep burn, which depends critically on having a source of independent neutrons, is the once-through deep-burn cycle. Here, the blanket reactivity can be maintained at a sufficient level so that the fuel does not have to be removed from the reactor for very long periods of time, implying that no reprocessing is required. Also, an independent neutron source allows the possibility of burning a wide variety of fuels, even natural uranium. In this case no enrichment is needed. The once-through deep-burn cycle produces large amounts of energy and minimizes its own waste, although it is inefficient for burning waste from other systems.

One main challenge for the concept is economics. Each deep-burn hybrid reactor would require a blanket plus a fusion neutron source with essentially all of the physics and technology required for a pure fusion system. Therefore, one has to measure the overall system cost of the fusion core (which is likely to be high) plus the fission blanket against that of an LWR plus the cost of alternate waste management strategies. A second main challenge is the development of a fuel form that can maintain its integrity for the extended time that it would remain in the blanket. The proposed systems also require the development of lithium-bearing liquid salt coolant for this blanket.

Another approach is to make use of inert matrix fuel. Ideally an inert matrix fuel consists of an “inert” material into which are embedded nuclear waste actinides. As neutrons bombard the actinides they will ultimately cause the desired transmutation reactions if sufficient irradiation can be achieved, thereby disposing of the waste. The purpose of using an inert material, as opposed to U-238 for instance, is as follows. As the term implies, no new actinides are produced when neutrons strike an inert material. Clearly, such materials could play an important role in waste management, but they would still not completely eliminate the need for a repository. There has been a relatively large international effort to study the appropriate matrix materials for use in fission reactors and accelerator-driven hybrids. But the discovery of a material that satisfies the combination of nuclear, chemical, and mechanical constraints inherent in a hybrid, as well as in other systems, remains an open question requiring a substantial R&D program.

2.3.4 Economics

Without a working prototype, economic projections for a hybrid are speculative at best. Even so, it is generally agreed that a hybrid blanket would be more technologically complex than either a pure fusion reactor or an LWR. Furthermore, because of its lower

power density, a pure fusion reactor of given output power would almost certainly be more expensive than an equivalent LWR.

How then can the hybrid compete economically? Advocates suggest that the attractiveness of the hybrid lies in its potential to provide waste management and fuel supply in a leveraged way — one hybrid might support the waste management and fuel requirements for multiple LWRs. For example, if the hybrid burner can significantly reduce the number of geological repositories required, this would result in a substantial cost savings. A realistic economic analysis thus requires a complete system evaluation. The total combined system cost, including the hybrids, must then be compared to the cost of other alternative methods, such as repository capacity, fast burners, or fast breeders, for accomplishing the same goals.

2.3.5 Safety

Safety is a major factor for public acceptance. A fusion reactor is generally considered “safe” and a subcritical fission reactor is arguably “safer” than its critical counterpart. It is nevertheless worth noting that the main safety issues with respect to LWRs are normally associated with loss-of-coolant accidents and not criticality accidents. Mixing fusion and fission together in one facility will likely introduce new safety issues. Therefore, the safety of a fusion-fission hybrid using a subcritical fission blanket should be evaluated on a concept-by-concept basis in light of new potential accident initiators and their consequences in a manner similar to the evaluation done for fission reactors and accelerator-driven hybrids. In the end, hybrids may have attractive safety features, but this is not a given. An extensive R&D program will be needed to prove this point.

2.3.6 Time Scale

The time scale for the development of fusion-fission hybrids is an important issue. Natural uranium should be available at reasonable cost for at least 50 years, and spent fuel can be stored on site in pools and dry cask storage for at least 50 years. Even so, it is crucial to emphasize that 50 years is not really a long time because of the substantial development and testing times that will be required for any new or even modified nuclear technology in order to qualify for licensing by the Nuclear Regulatory Commission. Furthermore, it will take decades to burn fission wastes in any of these approaches.

There is a variety of opinion on how long it will take to develop a fusion-fission hybrid for commercialization. If the need is indeed half a century away, there should be enough time to develop the hybrid, but only if research on certain critical components starts sooner rather than later.

2.3.7 Proliferation

Hybrids produce significant quantities of fissile materials generally not retained in individually accountable fuel rods, which raises significant proliferation concerns. Using fusion to transmute plutonium and minor actinides does not avoid the reprocessing step,

although reprocessing may be reduced compared to some pure fission scenarios. Thus, this approach inherits the diversion risk generally associated with reprocessing. The once-through burn-and-bury concept requires a flow of many millions of fuel spheres through the system every few months. This flow, and the associated flow of damaged spheres for replacement, also represents a significant diversion risk. The system also accumulates a very large tritium inventory. Production of fissile fuel in a fission-suppressed blanket entails large flows of liquid fuels that are difficult to account for, again presenting a potential diversion risk. Since all of these systems would contain large amounts of fissile material, either in the fission blanket or in the associated processing systems, they all present risks associated with the possession of this material at a time of a potential “breakout” from the Nonproliferation Regime by rogue regimes in certain countries.

2.3.8 Summary

Clearly, there are many physics and technology issues that must be resolved before the hybrid becomes a reality. Many of these challenges have a good chance of being overcome using existing knowledge in fission research — they basically require resources and time. The most uncertain component of the hybrid is, as it has been for many years, the fusion core. A combination of unknown physics and technological complexity make the fusion core the highest-risk component of the hybrid.

2.4 What Is the Main Competition Facing the Fusion-Fission Hybrid?

The discussion so far has focused on fusion-fission hybrids — what can they do and what are the scientific and technological challenges that each concept must overcome to achieve success? There are several important applications and many concepts to choose from. Ultimately, a combination of experiment, theory, and analysis will lead to a down-selection among the various hybrid concepts. However, there is a higher-level issue to consider. Even if the hybrid is successful it must be compared to other alternatives that can accomplish the same mission. This section describes the main alternate strategies that compete with the fusion-fission hybrid. They naturally break down into two categories: fuel production and waste management.

2.4.1 Fuel Production

The competition to hybrids for fuel production is fast breeders, accelerator-driven hybrids, and uranium extraction from seawater. The technology of the fast breeder has been investigated for many years by the fission community. Because of this extensive experience, near-term technological success for the fast breeder is reasonably likely — relative to the hybrid, it is much closer to fruition. However, some hurdles remain. The breeding time for additional fuel to supply one reactor is long, about 10 to 20 years, which leads to the conclusion that all or at least a large part of the fleet of LWRs must be transformed into breeder reactors. This is an expensive requirement, since a breeder with a given output power costs more today than a corresponding LWR, although it will likely cost less than a fusion system. Even so, when the fusion reactor is designed to be a fuel-producing hybrid, the neutron-rich property implies that fewer hybrids might be needed

to produce the same amount of fuel as pure fission breeders. The overall systems cost of a relative few hybrid breeders combined with light water reactors should be compared with either a mixed-fission, LWR-plus-breeder system or a full-fission breeder approach.

Accelerator-driven hybrids are generically similar to fusion-fission hybrids. In this case, the fusion core is replaced by a high-energy particle accelerator and target to serve as the neutron source for the fission blanket. Accelerators have the advantage of being a more developed technology than fusion devices, although the target technology at the high power levels required is a significant challenge. A main practical difference between accelerators and fusion-fission hybrids is the cost per neutron produced. This is a comparison that needs further study, but appears to favor fusion. Fusion also has the advantage of providing a variable-strength neutron source that will enable more flexibility in operation.

The last fuel production option is extraction of uranium from the ocean. There are enormous but very dilute reserves of natural uranium in the ocean. It is not difficult to extract this uranium, but its costs are presently prohibitive. Also, the volume of seawater that would have to be processed every year to fuel the fleet of light water reactors is enormous, which raises questions of environmental acceptability. Even so, the cost of ocean extraction of uranium should be considered as a ceiling for the acceptable costs of either fusion-fission or accelerator-driven hybrids.

2.4.2 Waste Management

A similar set of options exists for waste management. The main options are fast reactors (breeders and burners), accelerator-driven hybrids, and various types of repositories. In waste management, fast burner and fast breeder reactors could be relied upon. Fast burners are envisioned for reducing the inventory in transuranic actinides, specifically plutonium and minor actinides. Fast breeders are envisioned for reducing the inventory in minor actinides, while maintaining or increasing the plutonium inventory. Fast breeders are generally associated with nuclear growth scenarios, because of their ability to consume U-238 through Pu-239. Burners are generally associated with nuclear phase-out scenarios because they seek to minimize the production of Pu-239, therefore significantly reducing natural resource amplification through the U-238/Pu-239 approach. There is in fact not a great difference between the design and projected cost of a fast burner and a fast breeder. Hybrid advocates point out that a hybrid reactor used for waste management can burn fuel with a much higher percentage of actinides, since criticality issues are greatly reduced by virtue of the presence of an independent, external neutron source. This feature can be important in the overall system economics.

Accelerators can be used for transmutation in a similar fashion as for fuel production, and a similar assessment holds. Accelerators are better established technologically but their cost per neutron must be compared to that of fusion drivers.

Regional interim storage and on-site storage may also be part of the complete waste management strategy. Today, however, all commercial nuclear waste is stored on site.

This strategy can continue for another 50 years or longer, until a clear strategy is developed by the government. On-site storage is clearly not a long-term sustainable strategy.

To keep open the option of eventually using the U-238 in spent fuel to produce Pu-239 as LWR fuel, a set of interim storage facilities would have to be part of the waste management strategy. Creating the facilities would not be particularly difficult, but the large-scale conversion of U-238 to Pu-239 would require reprocessing at some point before the final fuel form is produced. One should also keep in mind that there is a large reserve of relatively “clean” U-238 in enrichment tails, which could be utilized before switching to spent fuel from reactors.

The last option involves repositories for permanent disposal. Geological repositories and deep boreholes are two such options. Long-term geological storage, such as that envisaged at Yucca Mountain, corresponds to truly permanent burial of high-level nuclear waste from commercial nuclear power plants. Once waste is buried in a permanent geological repository, there is very little chance of directly recovering the inventory of Pu-239 or any U-238 that could be used to breed Pu-239 to produce reactor fuel.

Direct burial of once-through waste eliminates the need for reprocessing for waste management purposes. It has been studied exhaustively and found to be a scientifically satisfactory method of disposing once-through nuclear waste. Yucca Mountain may still be reviewed by the Nuclear Regulatory Commission for an operating license, even though the administration has stopped construction work on the project. While the technological problems of Yucca Mountain (or other potential repositories) may be solved, the political problems remain, and they may confront any other future proposed geological repository site.

Many scientists and engineers favor a strategy that employs the interim storage option, since it keeps open the possibility of producing LWR or breeder reactor fuel after natural uranium reserves are depleted.

Lastly, most studies to date show that from a purely technological standpoint waste management is most economically addressed using a repository strategy. This conclusion must be considered against the recognition that no geological repository for spent fuel and other high-level waste has been successfully sited and operated. Until such time, the costs for direct disposal are still somewhat speculative.

References

1. L. M. Lidsky, *Nuclear Fusion*, Vol. 15, p. 151 (1975)
2. A. Sakharov, *Memoirs*, 1978, translated by R. Lourie (Knopf, 1990)
3. H. Bethe, *Physics Today*, p. 44 (1979)
4. R. W. Moir, *Nuclear Engineering and Design*, Vol. 63 p. 375 (1981).
5. W. Manheimer, *Fusion Technology*, Vol. 36, page 1, 1999

6. Y. Gohar, *Fusion Engineering and Design* Vol. 58-59, p. 1097 (2001)
7. W. Manheimer, *J. Fusion Energy*, 20, 131, 2001 (2003)
8. W. Manheimer, *J. Fusion Energy*, 23, 223, 2004, (2005)
9. W. Manheimer, *J. Fusion Energy*, 25, 121, 2006
10. W. M. Stacey et. al., *Nuclear Technology*, Vol. 162, p. 53 (2008)
11. LIFE “*Laser Inertial Fusion-Fission Energy*,”
https://lasers.llnl.gov/missions/energy_for_the_future/life/
12. E. I. Moses et al., “A Sustainable Nuclear Fuel Cycle Based on Laser Inertial Fusion Energy,” *Fusion Sci. Technology*, 56(2):547-565, 2009.
13. W. Manheimer, *J. Fusion Energy*, 28, 60, 2009
14. M. Kotschenreuther, P. M. Valanju, S. M. Mahajan, and E. A. Schneider, *Fusion Engineering and Design*, Vol. 84, p. 83 (2009)

Chapter 3

Fusion-Fission Fuel Cycles

Bob Hill (Chair), Yousry Gohar, Rob Goldston, Swadesh Mahajan, Stuart Maloy,
Ralph Moir, Kemal Pasamehmetoglu, Jim Tulenko

3.1 Fission Fuel Cycles

Nuclear energy currently provides about 20% of U.S. electricity usage and is the dominant clean source of energy production in terms of avoided carbon emission — 3 billion metric tons since 1970. However, widespread application of nuclear power has raised concerns related to the accumulation of spent nuclear fuel, the protection of nuclear materials and control of nuclear technology, and the availability of uranium supplies. With the potential to also contribute to the transportation sector (through plug-in hybrids and process-heat applications, for example), nuclear power is anticipated to undergo expansion. However, an expansion achieved by a business-as-usual continuation of current fuel cycle practices could be accompanied by substantial increases in geologic repository capacity, continued international accumulation of plutonium in stored spent fuel, and, in the long term, inefficient use of limited uranium resources.

Both domestic and international drivers motivate the implementation of alternative fuel cycles (such as a closed fuel cycle). Domestic drivers include the optimal use of the proposed geologic repository at Yucca Mountain, near-term management of spent nuclear fuel, and recovery of the energy value in spent nuclear fuel. International drivers include how the United States can influence global nuclear materials management, provide guidance for policy decisions on governance regimes, and exert leadership in defining advanced systems for proliferation resistance. Successful implementation of advanced fission fuel cycles would help address these issues by improving waste management and resource use.

3.1.1 Waste Management

The current once-through fuel cycle employed in the United States envisions direct disposal of spent fuel from light water reactors (LWRs). Extended delays in establishing a geologic disposal site have resulted in the protracted storage of spent fuel at the current LWR sites. In the meantime, fuel cycle options to improve waste characteristics, simplify disposal requirements, and maximize disposal efficiency are being explored. The transuranics present in LWR spent fuel are the primary contributors to the waste characteristics that pose the greatest disposal challenges (in particular medium- and long-term heat loads). In closed fuel cycle options, the transuranics are separated from spent fuel and recycled for transmutation into fission products with more amenable waste characteristics. This process, commonly called “actinide burning,” can facilitate improved waste management and disposal. Furthermore, the transuranics include plutonium, the primary proliferation concern in the spent fuel materials. Thus, burning of transuranic elements also yields a proliferation resistance benefit by eliminating weapons-usable materials from the waste. This benefit must be balanced against the

proliferation concerns that arise during the spent fuel reprocessing component of the closed fuel cycle.

An intense, sustained neutron flux is required to fission significant amounts of transuranic material, and a variety of possible neutron sources (a nuclear reactor, accelerators with spallation targets, etc.) have been proposed. The primary advantage of nuclear reactor systems is the demonstrated technology of fission reactors coupled to an efficient secondary system for converting fission energy into reactor power. *Any fission-based destruction system “burns” transuranics at the same rate, about 1 MWth-day per gram fissioned.* However, proposed reactor systems have a wide variety of transmutation characteristics and fuel cycle strategies. All conventional reactor systems use fuel that is primarily uranium; thus, the destruction of plutonium is at least partially compensated by in situ production of Pu-239. A variety of alternative fuels have been proposed (such as inert matrix or thorium base), but such fuels are a significant departure from nuclear power experience and currently are at the initial testing stage.

A variety of multiple-tier fuel cycle strategies have been conceived where the transuranics are partially consumed in commercial systems, with the remaining material passed on to a dedicated fast-spectrum burner. This approach is intended to provide a path for transmuting the waste material, particularly early in the process when the fissile content is still high. However, if the initial irradiation is conducted in a thermal spectrum system, the fissile materials will be preferentially consumed. Furthermore, significant quantities of radioactive higher actinides (americium and curium) would be generated, particularly with deep burn-up.

The hard neutron energy spectrum of fast reactor systems leads to several favorable effects for transuranic management. First, actinides preferentially undergo fission instead of conversion to still-higher actinides, because the fission-to-capture ratio is much higher, as shown in Figure 1. This effect implies that fast systems are more “efficient” in destroying actinides because fewer neutrons are lost to capture reactions before eventual fission. Furthermore, the generation of higher actinides (which can be problematic for recycle fuel fabrication and handling) is suppressed.

3.1.2 Resource Extension

For fission to make a significant dent in the carbon emission problem, the number of fission plants needed worldwide would quickly outstrip uranium resources. As a limiting example, assume that all coal-powered plants are replaced by nuclear power by the end of the century. This could result in nuclear generation as high as 1 TWe in the United States and 10 TWe in the world, or more. In this context, closing the fuel cycle and breeding become high priorities. In the current once-through fuel cycle, only about 1% of the energy value of the uranium is converted to power; most of the uranium is located in the depleted uranium enrichment tails, with the remainder present in the spent fuel.

The traditional fission approach for this mission has been to exploit the neutron balance in a fast spectrum, which allows a net production of fissile material. Fast breeder reactor

configurations were envisioned for a rapidly expanding nuclear power economy where fissile material was scarce and expensive. In general, this approach requires the loading of excess uranium (typically in depleted uranium blankets) to capture the excess neutrons.

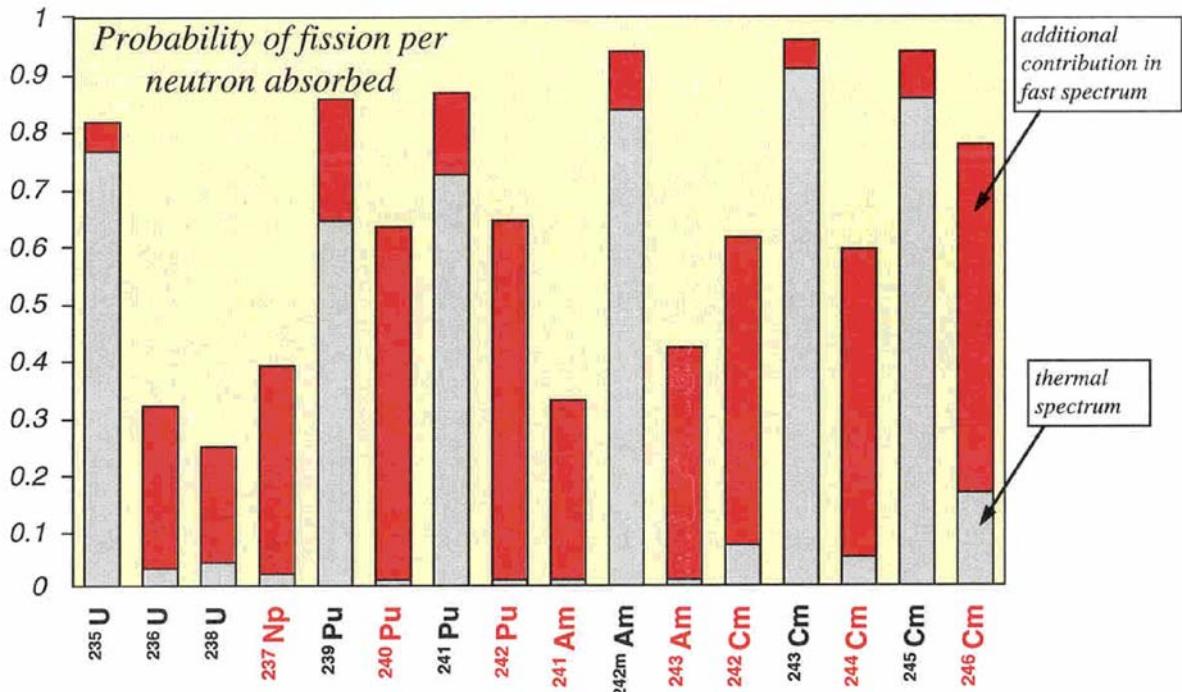

Figure 1. Comparison of fast and thermal spectrum fission/absorption ratio.

An alternative to the uranium-plutonium closed fuel cycle is to utilize thorium as the fertile material. The thorium cycle requires a fissile startup material, since none is present in natural thorium. Thereafter, U-233 is generated by neutron capture in the thorium. This process allows a closed fuel cycle that generates power from thorium resources, which are more extensive than worldwide uranium resources. Even so, one must keep in mind that there are enormous amounts of uranium available if the fuel is efficiently burned in a closed cycle. Still, the use of thorium is a strategy particularly applicable to India, which has extensive natural resources of this material.

3.1.3 Recent International R&D

The international nuclear energy R&D programs in Japan, France, the United States, Russia, India, China, and South Korea all include the development of fast reactor technology for use in a closed fuel cycle. Demonstration and test reactors either exist or will be started shortly in Russia (with the BN-600 operating and the BN-800 under construction), Japan (the Monju restart imminent), India (DFBR near completion), and China (CEFR near completion). This group of reactors uses sodium coolant technology with limited R&D on lead coolant (in Russia) and gas coolant (in France).

There has been extensive investment in sodium-cooled fast reactor (SFR) recycle technology, with limited demonstration of both oxide fuel (France and Japan) and metal fuel (United States). The current R&D being conducted for these fast reactor systems is directed at cost reduction, where a variety of innovative features (such as compact configuration, modular fabrication, advanced materials, high-fidelity simulation, and advanced energy conversion) are being explored.

3.1.4 Proliferation Issues for Fission Systems

There are three basic scenarios for nuclear proliferation in fission systems: 1) clandestine production of fissile material in an undeclared facility, 2) covert diversion of such material from a declared and safeguarded facility, and 3) use of a declared facility in a breakout scenario, in which a state produces fissile material for weapons in a previously safeguarded facility after exiting from nonproliferation agreements.

Clandestine production of fissile material in an undeclared facility: The largest risk in this category is associated with advanced uranium enrichment facilities, such as cascades of centrifuges. It has been estimated that a system not much larger than a basketball court, drawing less than 250 kW from the line, could produce material for one bomb per year. Such a covert system would be very hard to detect, particularly in an environment near much larger enrichment facilities. Breeder reactors would obviate the need for enrichment facilities, and so the spread of this technology might be slowed. Furthermore, large declared enrichment facilities could not be used to shield the environmental signatures of smaller, clandestine facilities.

Covert diversion of fissile material from a declared and safeguarded facility: Light water reactors use a relatively small number of fuel rods, and a much smaller number of fuel assemblies. These can be accounted with relative confidence, even as they are transferred to cooling ponds and cask storage. There is a much greater concern, however, about reprocessing systems. Large flows of plutonium are inevitably contained in such systems, and accounting to better than 1% has not been achieved. In a world economy with 3 TWe from breeders, the flow of plutonium would correspond to ~1,000,000 Nagasaki bombs per year. Reprocessing techniques are being developed to avoid separation of pure plutonium, but it is generally acknowledged that no such technique is tamper-proof.

Breakout from nonproliferation agreements: All fission reactors, cooling ponds, cask storage systems and reprocessing plants contain enough plutonium to manufacture many bombs. Thus if a participant in the Nonproliferation Treaty chooses to exit the treaty at any point, there is little that the world community can do to prevent it from processing plutonium into bombs, short of land invasion. Conventional bombing of a nuclear reactor, storage facility, or reprocessing plant to prevent access to its stored plutonium is not a viable alternative, because of the high level of associated radioactivity.

3.2 Fusion Fuel Cycles

3.2.1 Goals and Objectives

In fusion D-T neutron sources, the neutrons are generated from the $D(T,n)^4\text{He}$ nuclear reactions, which require deuterium and tritium. Deuterium is naturally available but tritium has to be produced through $^6\text{Li}(n,\alpha)\text{T}$ and $^7\text{Li}(n,n'\text{T})^4\text{He}$ nuclear reactions inside the reactor blanket. The lithium-6 reaction reactions consume neutrons but the (n,xn) and lithium-7 reactions do not. Therefore, more than one tritium atom is produced per source neutron. In the fuel cycle of fusion reactors, external tritium is required to start the reactor operation, and then the produced tritium can fuel the operation. The related technical issues are tritium recovery and control. Experiments have been successfully performed around the world to demonstrate portions of the tritium fuel cycle operation, from both solid and liquid tritium breeders. ITER will have breeding blanket system experiments to explore the tritium fuel cycle of future fusion power reactors as well.

In subcritical cores operating at subcriticality values $K_{\text{eff}}=0.95$ and 0.98 , the neutron multiplication factors are approximately 20 and 50, respectively. However, the use of 14.1 MeV neutrons (D-T neutrons) to drive these subcritical cores increases the neutron multiplication factor because of the extra neutrons produced per fission reaction and the neutron multiplication through (n,2n) and (n,3n) reactions. It is possible to double the neutron multiplication depending on the subcriticality level and the fission blanket design. This extra multiplication benefits the fusion-fission core performance in several ways. About one of these generated neutrons is consumed for every one extractable tritium atom produced per source neutron through the interaction with lithium atoms.

In the fusion-fission reactor, the tritium breeder material can be homogeneously integrated in the blanket or positioned at discrete locations. Liquid breeders (using lithium, lithium-lead eutectic, etc.) and solid breeders (Li_2O , Li_2TiO_3 , Li_4SiO_4) can be used in both cases. Blanket modules dedicated for tritium breeding can be located between or behind the fission blanket modules where a solid or liquid tritium breeder can be used. Such heterogeneous configurations can use conventional reactor fuel design in the fission blanket modules, but it increases the complexity of the fusion-fission blanket design. The other configuration integrates the tritium breeding function with the fission blanket. In both approaches, the reactor power during operation can be maintained at a constant level by adjusting the mass of the transuranic in the blanket.

Similar approaches can be used for fissile material production from uranium-238 or thorium-232. Again, the fast neutron spectrum will be more appropriate for enhancing the production of the fissile isotopes.

3.2.2 Recent International R&D

Operating experience does exist for some fusion fuel cycle technology options. For example, molten salt (Flibe) with uranium, thorium, and plutonium was successfully used as fuel carrier for fission reactors. Also, Flibe is under development for fusion reactors,

and it is an option for accelerator-driven systems and Generation IV fission reactors. Flibe technologies were developed at Oak Ridge National Laboratory for the molten salt breeder reactor program in the 1960s and at Argonne National Laboratory for the molten salt processing program in the 1990s. Also, the fast breeder program at ANL developed molten salt technologies for the integral fast reactor (IFR) fuel cycle in the 1990s. Liquid metal eutectic has been used for cooling fission reactors in Russia and liquid lead coolant is also under development for fission reactors. Bismuth-lead eutectic technologies have been developed and tested for accelerator-driven systems around the world. A lithium-lead eutectic system has been developed as a coolant and breeder for fusion power blankets. These technological developments and the operating experience with them provide the knowledge base for considering and starting to develop the different approaches for hybrid systems.

3.2.3 Proliferation Issues for Pure Fusion Systems

The same classes of proliferation risk for fission can be analyzed for fusion:

Clandestine production: One could produce fissile material using a compact steady-state copper or superconducting tokamak or inertial fusion energy (IFE) system that produced approximately 25 MW of fusion power. If a duty factor in the range of 85% could be achieved, such a facility could produce approximately 30 kg of plutonium (about four weapons-significant quantities, SQ) per year. If it were able to operate clandestinely, it would be a significant proliferation risk, but the requirement for at least 200 MW of continuous power input and cooling and thereby a large electric supply line, large power conversion buildings, and a significant cooling facility, as well as a large, very well-shielded hall, would make such an installation quite visible. The large remote-handling capabilities for such a high-duty-factor deuterium-tritium facility would also be very visible. Based on experience with tokamak fusion test reactors, trace levels of tritium lost from the facility would be detectable for a distance of tens of kilometers, in addition to the environmental signatures of fertile and fissile materials. Overall, the clandestine construction and operation of such a facility is not credible.

Covert production: A Pb-Li cooled tokamak would have approximately 1500 tons of coolant, and if 0.05% of the Pb were replaced with Th or U-238, the device would produce about 1 SQ per year. The detection of this level of U-238 from its characteristic γ emission near coolant pipes would be straightforward, as would detection of γ 's from the small amount of U-232 that would be produced. Chemical sampling would be extremely clear as well. The covert injection of about 750 kg of fertile material into the coolant would be difficult, and covert extraction of 8 kg of fissile material dissolved in 1500 tons of PbLi, at 5.3 ppm, does not appear to be a practical strategy. The use of tristructural isotropic fuel (TRISO)-like particles would facilitate the extraction of the fissile material. Nonetheless, the injection and extraction systems should be detectable in regular design information verifications.

In the case of solid breeder blanket modules, incoming components would have to be inspected for the presence of fertile material, as is currently done with fresh fuel for

fission reactors. Inspection might be accomplished by passive means, looking for either gammas or neutrons in coincidence, or by using the 14.1 MeV active neutron interrogation techniques that have been developed for detection of nuclear materials in shipping containers. About 750 kg of fertile material would have to be brought on site to produce one SQ per year, and would be easily detectable.

Sensitive environmental sampling techniques would provide strong additional confidence in detecting covert use of a fusion power plant to produce weapons-usable material, since no fertile or fissile materials need be present at a fusion system. Overall, covert production of fissile material in a safeguarded pure fusion reactor does not appear to be a credible proliferation risk.

Breakout from nonproliferation agreements: The final scenario that should be considered is “breakout,” as happened in North Korea. A critical aspect of the breakout scenario with fission is that *significant weapons-usable material has already been produced at the time of such a breakout*. In the fission breakout case the only options for assuring that the fissile material is not subsequently employed for military purposes are 1) large-scale missile attack that would spread radiation over civilian populations, including in other countries, 2) continuous smaller-scale missile attack to prevent access to the fissile material, and 3) invasion. These alternatives were judged unacceptable in the case of North Korea. The case of a fusion power plant, however, is significantly different. *No fissile material would be available at the time of breakout* if the facility were previously safeguarded.

The two quickest ways to begin to manufacture fissile material in a previously safeguarded fusion system are either 1) to introduce approximately 2% Th or U-238 TRISO-like particles (30 tons, hundreds of TRISO particles per cm³) in a liquid coolant or 2) to replace a subset of the blanket modules, perhaps using specially designed Test Blanket Module ports of the type that ITER employs, inserting modules optimized for fissile material production. Design features could be incorporated to make either of these possibilities more time consuming, but in either case set-up of the device to operate with the loaded fertile material can be estimated to require 1 to 2 months, and subsequent production of 1 SQ of fissile material would take about 1 week. However, during this period after breakout the international community could use remote means to disable the fusion reactor with no risk of spreading radiation (for example, by disabling the cryoplant, power conversion equipment, or cooling tower). Nonproliferation experts consider this remote means of disabling the plant as a significant difference from a fission breakout.

3.3 Proposed Hybrid Fuel Cycles

In this section, the fuel cycle role of the different hybrid concepts will be described. Hybrid fusion-fission systems have been proposed to meet either the waste management or resource extension goals identified in 3.1 for the fission fuel cycle. In addition, the hybrid device would also need to meet the fusion fuel cycle goals identified in 3.2.

For the waste management role, some of the hybrid concepts are envisioned to burn (fission) the entire inventory of transuranic elements present in fission reactor spent fuel. However, for many concepts the hybrid device is tailored to consume only the minor actinides with the plutonium destined for fission reactor recycle. This reduces the capacity requirement substantially, implying fewer hybrid systems to support a given fission reactor fleet.

A favorable aspect of the driver hybrid system for the burning mission is the lack of criticality constraints. In theory, this allows the fusion hybrid to operate on very low reactivity fuels or fuels with a very low fraction of delayed neutrons that can drive the system to very high fuel burn-up. However, a variety of operational challenges (sustained power production) and technological challenges (fuel burn-up and/or radiation damage limits) must be overcome to realize this potential.

Other hybrid concepts (breeders of fuel for LWRs) have been configured specifically for the resource extension role. One concept is to multiply fusion neutrons and absorb them in lithium (to meet the fusion fuel cycle goal) and thorium (to make U-233). These designs are called fission-suppressed fusion breeders.

One concept proposed a combination of breeding and ultra-high burnup for a breed and burn concept (once-through burn and bury). The fusion neutrons create the initial fissile material, after which there is significant multiplication to help drive the burning. This fuel cycle approach could completely destroy fertile material for energy generation. However, the materials challenges are daunting (such as complete burn-up and high radiation damage). The proposed fuel system using ferritic steel spheres to contain the fissile material, with flowing FLiBe for coolant, is completely new. It should also be noted that the consequence of the resource extension capability of such systems would be that they would be very slow to reduce the SNF inventory, since they would burn the U-238 as well as the plutonium and minor actinides.

In any case, the power production (1 MWt-day/gram fissioned) generated by the waste management role will be quite substantive, and this power will be greatly multiplied in the resource extension mode. Thus, an important goal for the hybrid system must be to include an energy conversion system for the efficient (economical) and safe conversion of the fission energy to useful products (either electricity or process heat). For this aspect, the fission energy technology provides a useful starting point, but specific aspects of the fusion system coupling (such as fusion neutron source configuration, operating temperature regime, and so on) may lead to different technology solutions.

3.3.1 Proliferation Issues for Fusion-Fission Hybrids

Clandestine production in an undeclared facility: Overall hybrid systems, like pure fission breeder systems, would eliminate the need for enrichment facilities. This would reduce the risk of clandestine production of fissile materials, because the technology for enrichment would be less widespread and large, declared facilities could not be used to mask the environmental signatures from smaller, clandestine facilities.

Covert production and/or diversion of fissile material in a power reactor under safeguards: Hybrids produce significant quantities of fissile materials, generally not retained in individually accountable fuel rods, and hence raise significant proliferation concerns. Using fusion to transmute plutonium and minor actinides does not avoid the reprocessing step, although reprocessing may be reduced relative to pure fission scenarios. This approach thus inherits the large diversion risk generally associated with reprocessing. The once-through burn-and-bury concept requires a flow of the many millions of fuel spheres through the system every few months. This flow, and the associated flow of damaged spheres for replacement, represent significant diversion risks. This system also accumulates a very large T inventory. Production of fissile fuel in a fission-suppressed blanket entails large flows of liquid fuels that are difficult to account for, again presenting a significant diversion risk.

Breakout from nonproliferation agreements: Since all of these systems would contain large amounts of fissile material, either in the fission blanket or in the associated processing systems, they all present significant risk associated with the possession of this material at the time of a potential "breakout" from the Nonproliferation Regime.

Chapter 4

Fusion-Fission Hybrid Drivers

Harold Weitzner (Chair), Benjamin Cipiti, Jeff Harris, Mike Kotschenreuther, Wally Manheimer, Wayne Meier, George Miley, Martin Peng, Dmitri Ryutov, John Sarff, John Slough, Bill Stacey, Erik Storm, Glen Wurden, Leonid Zakharov

4.1 Introduction

Many proposals exist for fusion drivers for the fusion-fission hybrid or possibly pure fusion systems. A few proposals have more or less complete conceptual designs, but most are at the preconceptual stage, in some cases with not much more than a general idea of what might be done. Even the goal of the system is not well defined. One system proposes a complete fuel cycle with power production and no significant radioactive waste from the process. A few proposals describe facilities that would burn (fission) the actinides in the spent nuclear fuel discharged from light water reactors (LWRs). Finally, there are a variety of suggestions for possible drivers.

It is likely that most of these systems could be redesigned to adapt to various fuel cycles and uses that might ultimately be chosen. The more advanced drivers proposed could credibly be deployed within about thirty years. The drivers separate naturally into three types, corresponding to the mechanism of plasma confinement: magnetic confinement, inertial confinement, and electrostatic confinement. The development paths are sufficiently different that each group is discussed separately. Each section will be organized by physical and/or technological affinity of the concepts rather than by the concept's state of readiness, which will be given and is based on the proposer's ideas and views. This section provides a very succinct view of the goals of each proposal and, where relevant, its timetable.

4.1.1 Magnetic Confinement

The first group of concepts is based on quasi-steady-state plasma confinement in a topologically toroidal domain. Several variations of toroidal confinement are considered, including the tokamak (the magnetic configuration best studied to date), its variants, and the stellarator. When the quasi-steady-state plasma is confined in a "tube" with open ends the system is identified as a mirror machine. All of these systems are considered to have the potential, albeit not yet realized, of steady-state or very-long-pulse operation. A pulsed system, based on colliding plasma plasmoids, is also discussed.

Toroidal Systems

The Georgia Tech group presumes the success of the ITER mission and shows how a tokamak based on ITER physics and technology could be configured with a subcritical fast burner fission reactor blanket based on the leading sodium-cooled fast reactor and associated processing technologies to produce energy and destroy the actinides in spent LWR nuclear fuel. The design could be carried out in parallel with ITER operation, and construction and component procurement could be initiated upon confirmatory

performance, leading to a deployment date of about thirty years hence. ITER would serve as the prototype or pilot plant for the fusion neutron source.

Zakharov and his coauthors from ASIPP Hefei in Anhui Province, China, propose a joint U.S.-Chinese project of a 50 MW to 100 MW fusion-fission research facility (FFRF) for the development and assessment of hybrid technologies for the use of the fast neutrons from a tokamak plasma. FFRF includes the fusion missions of demonstrating ignition and establishing a stationary burning plasma. The device relies on a particular lithium wall fusion plasma regime, which has demonstrated excellent performance in a number of existing machines. The design of FFRF depends on the successful outcome of the expanding programs studying this regime through the National Spherical Torus Experiment (NSTX) of the Princeton Plasma Physics Laboratory (PPPL), and on the stationary tokamaks (HT-7 and EAST) in Hefei. FFRF plans to install its first fission blanket sector in 2030.

Another solution to the difficulties of tokamaks is set forth in the University of Texas proposal, which employs a novel divertor configuration in a low aspect ratio configuration, a spherical tokamak (ST). Both of these modifications are expected to enhance the plasma behavior. The effects of low aspect ratio are generally accepted, being supported in both experiment and theory. The novel Super-X divertor has theoretical support but has not yet been tested. Installation and testing of the Super-X divertor in the British spherical tokamak, MAST, is planned. A major engineering innovation for the ST hybrid suggested by the Texas group is a removable fusion core inside the blanket, which is free-standing. Detailed engineering has not been done, but the group argues that the system could be built with present-day materials, which could withstand the predicted heat load and neutron fluxes. The removable core permits shortened lifetimes for its elements and might allow a modest number of not-too-powerful disruptions. Issues of heating and steady-state sustainment remain unresolved. This system is probably on a comparable or slightly longer timeline with respect to the two already described. However, it has a number of unique development issues that might require additional time and/or intermediate steps.

The reversed-field pinch (RFP) is similar to a tokamak with a toroidal field that changes sign within the plasma. The toroidal field is much smaller than in conventional tokamaks and thus the external magnets are also smaller. This plasma has the potential of ohmic heating to ignition. In recent years there has been substantial improvement in the plasma behavior of these devices. One expects the need for at least one additional facility, with possible upgrades, to realize the potential inherent in the RFP. Heating, current drive, and sustainment are all issues whose solution demands additional demonstration. The RFP is clearly not on the same timeline as the other tokamaks.

There has not been a proposal for a stellarator hybrid, but if one were to actively consider the possibility of a magnetic fusion hybrid, this concept should not be ignored. The stellarator is a toroidal concept, but without axisymmetry. The intrinsically three-dimensional magnetic fields confine the plasma. Stellarators do not require driven toroidal current and are inherently steady-state systems. Experiments show that

instabilities do not destroy plasma confinement. Adequate plasma heating is also essential for the hybrid. The United States has a very modest stellarator program, and any research is heavily dependent on work in Germany and Japan. Although stellarators can be difficult to build and may require intricate blanket designs, they have many potential advantages for pure fusion or the fusion-fission hybrid. Until a much larger stellarator program is reestablished in the United States, any stellarator hybrid program involving more than scoping studies is not realistic.

Mirror Systems

Experimental research on axisymmetric mirror machines has been actively pursued in Russia and in Japan. In recent years, the successes of these machines in overcoming the difficulties that caused the cancellation of the U.S. program have led to credible proposals for using axisymmetric mirrors for neutron sources and for the fusion-fission hybrid. A neutron source for subcomponent and materials testing with a neutron flux of 0.3 MW/m² can, according to advocates, be built without any extrapolation from the already-obtained plasma parameters. An attractive hybrid reactor would require an increase of the electron temperature above its present value of about 250 eV, and it is believed that with proper design the required electron temperature could be reached. There is no intrinsic limitation on the pulse length. The development of long-pulse or steady-state neutral beams, or some other heating source, is critical for future developments of this and other magnetic fusion energy (MFE) concepts. An active program might produce a pilot plant on a timeline comparable with tokamaks, depending on the success and possible complexity of necessary intermediate steps.

A Pulsed System

The proposal of Slough builds on recent successes in the field-reversed configuration (FRC) program. Two plasmoids are produced in separate chambers and are accelerated to hit each other and combine. The unified plasmoid is static with an increased temperature, the kinetic energy of motion having been transformed into thermal energy. If needed, the final plasmoid can also be heated to higher temperatures by additional compression. The proposed system has a number of significant advantages, many arising from the separation of the reaction chamber from the plasma production region and the relatively simple system geometry. While the present experimental system is far from what is needed for any fusion applications, Slough argues that the development path in which the underlying ideas are being tested involves a sequence of facilities with a cost orders of magnitude lower than other proposed systems in the corresponding phases. The developmental timeline is not clear at this point.

4.1.2 Inertial Confinement

The proposed inertial confinement systems differ in two characteristics: the implosion driver and the possibility of direct or indirect drive of the implosion. Most proponents envisage the possibility of a pure fusion system, although all envisage the possibility of more accessible hybrid roles for energy production and/or used fuel destruction. The

common developmental issues for the concepts involve demonstration of adequate energy gain, drivers with satisfactory repetition rates, and an inexpensive target manufacturer. Proponents believe that the development paths for these systems are no slower than for magnetic confinement fusion and might be faster. The Naval Research Laboratory (NRL) proposal involves direct drive with a KrF laser and sees a pure fusion application. The Lawrence Berkeley National Laboratory (LBNL) studies of heavy ion beam drivers consider the possibilities of either direct or indirect drive and either pure fusion or hybrid operation. The Z-pinch work of Sandia National Laboratories involves indirect drive and has focused on actinide burning. The Lawrence Livermore National Laboratory Laser Inertial Fusion Engine (LLNL LIFE) program uses indirect drive and proposes a complete system with energy production and no significant radioactive waste output. In this program, pure fusion would be possible with adequate gain.

4.1.3 Inertial Electrostatic Confinement (IEC)

At present, small commercial inertial electrostatic confinement (IEC) fusion devices are used to generate modest neutron fluxes for various applications typically involving neutron activation analysis (NAA). In the discussion of IECs, the advocates suggest that with some engineering improvements, such devices could be used to drive subcritical assemblies used in university teaching labs. Also, with improvements in confinement physics to increase fluxes, units could be developed to drive low-power research reactors (of few MW) for uses such as isotope production. Advocates point out that such facilities would be important components in the training of the next generation of nuclear engineers required to support future expansion of nuclear power. It is argued that this is especially essential in view of the closing of many university research reactors and aging teaching lab facilities across the country. Also raised is the possibility of the scale-up of such systems to generate neutron fluxes of interest for conventional hybrid breeder or burner applications, as well as for fusion materials studies. However, this requires significant improvements in IEC confinement physics to meet the high flux requirements, and very limited details are available because of the lack of conceptual design studies for high power IEC hybrids.

Presented below are more detailed descriptions of each of the proposed hybrid concepts as provided by the concept advocates.

4.2 A Tokamak Hybrid Neutron Source Based on ITER Physics and Technology (W. M. Stacey, Georgia Tech, October 16, 2009)

Over the past decade the group at Georgia Tech has examined (References 1–16) the application of a tokamak D-T fusion neutron source, based (insofar as possible) on the physics and technology of ITER, that could drive a subcritical fast transmutation (burner) reactor fueled with the transuranics from spent nuclear fuel (SNF). The purpose of such a reactor would be to stabilize the accumulation of spent fuel being discharged from LWRs by fissioning the transuranics in SNF to significantly reduce the number of high-level-waste storage repositories required. Both gas-cooled reactors operating on a “burn and

bury” non-reprocessing fuel cycle with tristructural isotropic (TRISO) transuranic fuel (the gas-cooled fast transmutation reactor, GCFTR) and liquid metal–cooled reactors operating on a “reprocessing” fuel cycle with transuranic metallic fuel (the subcritical advanced burner reactor [SABR] and fusion transmutation of waste reactor [FTWR]) have been considered, all driven by essentially the same tokamak neutron source. Determination of the required neutron source parameters for the SABR design is discussed here.

4.2.1 The SABR Design Concept

The SABR reactor is a loop-type, sodium-cooled fast reactor fueled with the ^{40}Zr -transuranic metal fuel being developed at Argonne National Laboratory (ANL). A fission power level of 3000 MWth was chosen to provide a significant transmutation rate; also, because there is experience with nuclear reactors of that power, existing power handling and balance of plant equipment can be used. The SABR design concept configuration is shown in Figure 1.

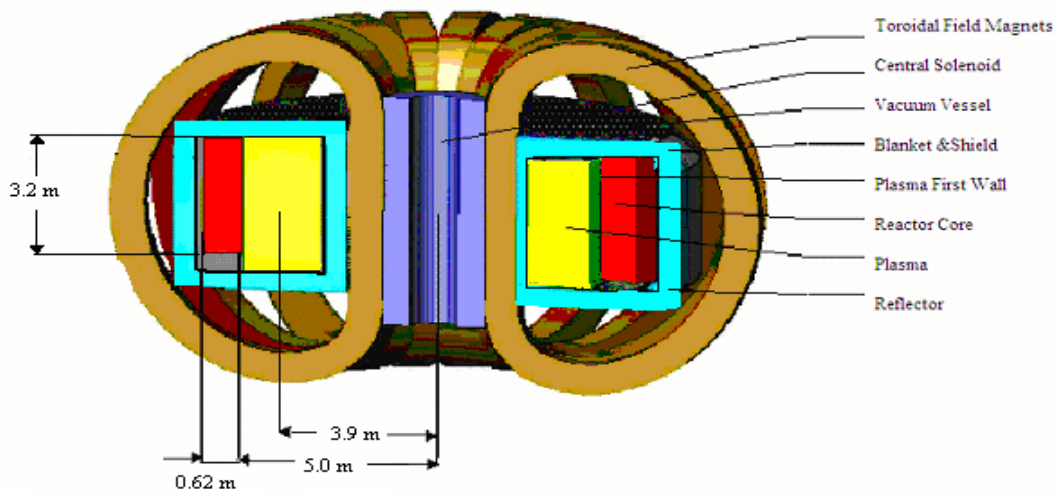

Figure 1. Configuration of SABR.

An annular fission core is located outboard of the tokamak plasma chamber, within the toroidal field coils. The reactor core was adapted from an ANL fast reactor design and consists of 918 vertical hexagonal assemblies, 15.5 cm–across flats, each containing 271 wire-wrapped 3.63 mm radius fuel pins with an active height of 2 m. This “leaky” annular core has a small but positive sodium void worth and a small negative Doppler coefficient. The fuel assemblies are arranged vertically in four concentric annular rings just outboard of the plasma chamber.

The power density is a modest 72.5 MW/m^3 , and the heat can readily be removed with Na flowing at 8700 kg/s, which requires 454 kW of pumping power (a lithium-niobate insulating coating on all fuel pins and structure eliminates magnetohydrodynamic [MHD] pressure drop). Heat is removed from the core in two separate sodium loops, each with

four EM pumps and two intermediate heat exchangers coupling to an intermediate sodium loop and finally to a secondary water system and turbines.

Tritium self-sufficiency ($TBR = 1.16$) is achieved with a 15 cm Li_4SiO_4 breeding blanket surrounding the plasma chamber and the reactor core, confirmed with dynamic burn-up and production-decay calculations.

4.2.2 Fuel Cycle — Determination of Required Neutron Source Strength

A four-batch reprocessing fuel cycle in which all the transuranics from SNF are fissioned to $\gg 90\%$ was examined, most recently using the ERANOS fast reactor physics code, to determine an upper limit on neutron source requirements. The total fuel residence time in the reactor between reprocessing steps is limited by 200 dpa radiation damage in the oxide-dispersion strengthened (ODS) steel clad and structure. Core refueling would be accomplished remotely.

With 32 MT of “fresh” transuranic fuel at beginning of life (BOL), $k_{\text{eff}} = 0.972$, an out-to-in fuel shuffling scheme was used, in which at the end of a 700-day burn cycle the fuel in the innermost fuel ring (next to the plasma) is removed for reprocessing, the fuel in the other three rings is shifted inward by one ring, and new fuel is loaded into the outermost ring. The fuel removed from the innermost ring is partitioned pyrometallurgically into fission products, which are sent to a geological repository, and transuranics, which are mixed with “fresh” transuranics from SNF, refabricated into fuel by arc casting, and recycled into the outermost ring of a SABR. (To be conservative, 1% of the fission products are assumed to remain with the transuranics, and vice versa.) Each batch of fuel is in the reactor for a residence time of 7.7 years (four burn cycles). After several burn cycles, an equilibrium is established in the compositions at the beginning of the burn cycle (BOC) and the end (EOC). This equilibrium fuel cycle has 29.0 MT of transuranics and $k_{\text{eff}} = 0.894$ at BOC, and 27.1 MT transuranics and $k_{\text{eff}} = 0.868$ at EOC. The corresponding neutron source strengths required to maintain 3000 MW fission power are $P_{\text{fus}} = 75$ MW (BOL), 240 MW (BOC), and 370 MW (EOC). Four batch-reprocessing fuel cycles with fuel residence time limited by 100 and 300 dpa structural material radiation damage limits required maximum (EOC) $P_{\text{fus}} = 220$ and 460 MW, respectively. Thus, it seems appropriate to design the fusion neutron source to produce up to $P_{\text{fus}} = 400\text{--}500$ MW. If the radiation damage limits could be overcome, transuranic burn-up greater than 90% could be achieved without reprocessing by leaving the fuel in until $k_{\text{eff}} < 0.6$, which would require a neutron source strength corresponding to $P_{\text{fus}} \gg 500$ MW to maintain $P_{\text{fission}} = 3000$ MW.

The transuranic fission rate is 1.05 MT per full-power year (FPY) of operation. Allowing for 60 days downtime for fuel shuffling after every 700 full-power day burn cycle at 76% availability during the burn cycle, SABR could fission all the transuranics in the SNF discharged annually from three 1000 MWe LWRs. For a given batch of fuel that is resident in the reactor for the four burn cycles between reprocessing steps, 23.8% of the transuranic material is fissioned.

4.2.3 Neutron Source Physics Parameters

Standard systems analysis of the tokamak physics and engineering constraints was used to establish the operating parameter range for tokamaks over a range of major radii and plasma currents. For a $R = 3.75$ m tokamak, the wide operating range over which the required fusion power levels can be achieved is shown in Figure 2, and the detailed parameters for $I = 8.3$ and 10.0 MA are given in Table 1. For comparison, the corresponding design parameters for ITER also are given in the table. Clearly, the plasma parameters for the neutron source are within the range that is anticipated in ITER, and, with the exception of Q_p , γ_{cd} , and availability, have already been achieved in existing experiments. Note that the required values of the important β and confinement parameters are routinely achieved in current experiments. The bootstrap current fractions are based on the ITER formula, and the required values of current drive efficiency that result therefrom are only somewhat larger than has been achieved (0.45 in JET).

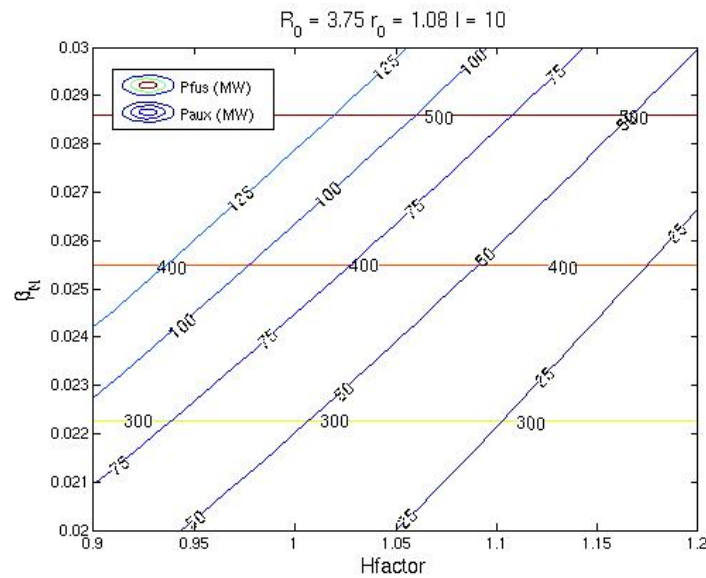

Figure 2. Operating space of SABR (GCFTR) at 10 MA (Horizontal lines indicate P_{fus} ; slanted lines P_{aux}).

Parameter	SABR nominal	SABR extended	ITER	Pure fusion electric
Major Radius R, m	3.75	3.75	6.2	5.2
Current I, MA	8.3	10.0	15.0	13.0
P _{fus} , MW	180	500	400	3000
Neutron Source, 10 ¹⁹ /s	7.1	17.6	14.4	106
Aspect Ratio A	3.4	3.4	3.1	4.0
Elongation κ	1.7	1.7	1.8	2.2
Magnetic Field B, T	5.7	5.7	5.3	5.8
B _{TFC} /B _{OH} at coils, T	11.8/13.5	11.8/13.5	11.8/13.5	11.8/13.5
Safety Factor q ₉₅	3.0	4.0	3.0	
Confinement H _{IPB98}	1.0	1.06	1.0	2.0
Normalized Beta β _N	2.0	2.85	1.8	5.4
Plasma Energy Mult. Q _p	3	5	5-10	>30
CD eff., γ _{cd} , 10 ⁻²⁰ A/Wm ²	0.61	0.58		
Bootstrap cur. frac f _{bs}	0.31	0.26		0.9
Neutron Γ _n , MW/m ²	0.6	1.8	0.5	4.9
FW Heat q _{fw} , MW/m ²	0.23	0.65	0.5	1.2
Availability, %	76	76	25(4)*	>90

Table 1. Tokamak neutron source parameters.

*ITER is designed to achieve a duty factor of 25% for burn periods greater than 10 minutes, to operate continuously for periods of 12 consecutive days, and to be capable of 24 hour per day plasma operation for periods up to 16 months during the testing phase. However, it is designed to operate only about 4% of the cumulative time over its 14 year DT operation period

4.2.4 Neutron Source Technology

Six 20 MW large helical reactor (LHR) launchers, based on the ITER design, are used for plasma heating and current drive. The austenitic steel in the ITER first wall and divertor was replaced with an advanced ferritic steel (ODS), and the designs were adapted to helium (GCFTR) and sodium (SABR) coolants. The helium coolant required a redesign of the divertor design for GCFTR to get more surface heat transfer area, while the same ITER channel dimensions could be used with sodium for SABR. However, the coolant channel walls must be coated with an electrical insulator (LiNbO₃) to prevent excessive MHD pressure drops with sodium. Heat removal capability was confirmed by detailed FLUENT calculations using the adapted ITER designs.

The central solenoid (CS) and toroidal field (TF) coils were scaled down from the ITER designs using the same cable-in-conduit Nb₃Sn superconductor surrounded by an Incoloy 908 jacket and cooled by a central channel carrying supercooled helium, with maximum fields of 11.8 and 13.5 T, respectively. The dimensions of the CS coil were constrained by the requirement to provide inductive start-up and to not exceed a maximum stress of 430 MPa, set by matching ITER standards and Incoloy properties. The dimensions of the

16 TF coils were set by conserving tensile stress calculated as in the ITER design, taking advantage of an Incoloy 908 jacket for support.

4.2.5 Shielding and Plant Lifetime

A multilayered shield surrounding the plasma chamber and reactor protects the superconducting magnets. Monte Carlo N-Particle (MCNP) and EVENT neutronic analyses predict that during the design lifetime of 30 FPY (40 years at 75% availability), the neutron fluence to the superconductor would be 7×10^{18} n/cm² and the radiation dose to the insulators would be 7×10^7 rads, safely below the limiting values of 10^{19} n/cm² and 10^9 – 10^{10} rads. The ODS steel first wall accumulates 200 dpa in 6.5 FPY and would need to be replaced during the two-month fuel shuffling shutdown after every third fuel cycle.

4.2.6 Dynamic Safety Analysis

Loss-of-power (LOPA), loss-of-heat-sink (LOHSA), loss-of-flow (LOFA), control rod ejection, and neutron source excursion accidents were simulated for the sodium-cooled SABR design using the RELAP5 code to model the reactor and heat-removal systems dynamics, together with a plasma power and particle balance model for the neutron source dynamics. According to the simulation: 1) the core power can be reduced to decay heat levels in a couple of seconds by turning off the neutron source heating power when any accident condition is detected; 2) a LOPA thus reduces the core to the decay heat level in a couple of seconds and natural circulation prevents core damage; 3) undetected LOFAs (neutron source remains on) in which 50% of the primary coolant pumps fail can be survived without core damage, and only when 75% of the pumps fail does fuel melting occur (at 8.4 s); 4) an undetected LOHSA with 50% loss of sodium flow in the intermediate loop can be survived without core damage, and only with 75% loss of sodium flow in the intermediate loop does fuel melting occur (at 150 s); and 5) neutron source excursions due to inadvertent increases in plasma heating or fueling could be limited by operation near inherent density and beta limits. An emergency core cooling system (ECCS) was not analyzed for SABR, but an ECCS was designed for the helium-cooled GCFTR design, which prevented core damage even with total loss of primary flow.

4.2.7 Comparison with Pure Fusion Electric Power

The technical requirements — neutron wall load, confinement, beta, availability — are much less demanding for SABR than for pure fusion electric power, as shown by the last column in Table 1 for the ARIES-AT design.

4.2.8 R&D Requirements

R&D for any fusion-fission hybrid (FFH)

Fusion R&D

- Fusion neutron source physics and plasma support technology
- Tritium breeding and extraction technology

Nuclear R&D

- Fission reactor physics and technology
- Transuranic processing and fuel fabrication

Materials R&D

- Radiation damage-resistant structural material (200 dpa)

Integration of fusion and fission technologies: A tokamak FFH neutron fusion source is on the path to pure fusion power

Fusion R&D for a Tokamak F-F Hybrid

- Ongoing worldwide tokamak physics R&D program, including ITER-specific issues (such as edge-localized mode [ELM] suppression, start-up scenarios)
- ITER construction and operation experience — ITER is the prototype for FFH neutron source
- Physics R&D on reliable steady-state, disruption-free operation, burn control, etc.
- Plasma support technology R&D (magnets, heating systems, etc.) for component reliability
- Fusion nuclear technology R&D (tritium breeding, etc.)
- Advanced structural materials (200 dpa) R&D
- Integration of tokamak and nuclear reactor technologies

Further Fusion R&D for Tokamak Electric Power

- Physics R&D on improved confinement and operational limits
- Advanced DEMO (prototype commercial reactor) construction and operation

References (The Georgia Tech tokamak proposal)

Neutron Source for Transmutation (Burner) Reactor

1. W. M. Stacey, “Capabilities of a D-T Fusion Neutron Source for Driving a Spent Nuclear Fuel Transmutation Reactor,” *Nucl. Fusion* 41, 135 (2001).
2. J-P. Floyd, et al., “Tokamak Fusion Neutron Source for a Fast Transmutation Reactor,” *Fusion Sci. Technol.*, 52, 727 (2007).
3. W. M. Stacey, “Tokamak Neutron Source Requirements for Nuclear Applications,” *Nucl. Fusion* 47, 217 (2007)

Transmutation (Burner) Reactor Design Studies

4. W. M. Stacey, J. Mandrekas, E. A. Hoffman and NRE Design Class, “A Fusion Transmutation of Waste Reactor,” *Fusion Sci. Technol.* 41, 116 (2001).
5. A. N. Mauer, J. Mandrekas and W. M. Stacey, “A Superconducting Tokamak Fusion Transmutation of Waste Reactor,” *Fusion Sci. Technol.*, 45, 55 (2004).
6. W. M. Stacey, D. Tedder, J. Lackey, J. Mandrekas and NRE Design Class, “A Sub-Critical, Gas-Cooled Fast Transmutation Reactor (GCFTR) with a Fusion Neutron Source,” *Nucl. Technol.*, 150, 162 (2005).

7. W. M. Stacey, J. Mandrekas and E. A. Hoffman, "Sub-Critical Transmutation Reactors with Tokamak Fusion Neutron Sources," *Fusion Sci. Technol.* 47, 1210 (2005).
8. W. M. Stacey, D. Tedder, J. Lackey, and NRE Design Class, "A Sub-Critical, He-Cooled Fast Reactor for the Transmutation of Spent Nuclear Fuel," *Nucl. Technol.* 156, 9 (2006).
9. W. M. Stacey, "Sub-Critical Transmutation Reactors with Tokamak Neutron Sources Based on ITER Physics and Technology," *Fusion Sci. Technol.* 52, 719 (2007).
10. W. M. Stacey, D. W. Tedder, R. W. Johnson, Z. W. Friis, H. K. Park and NRE Design Class., "Advances in the Subcritical, Gas-Cooled Fast Transmutation Reactor Concept," *Nucl. Technol.* 159, 72 (2007).
11. W. M. Stacey, W. Van Rooijen and NRE Design Class, "A TRU-Zr Metal Fuel, Sodium Cooled, Fast, Subcritical Advanced Burner Reactor," *Nucl. Technol.* 162, 53 (2008).
12. W. M. Stacey, "Georgia Tech Studies of Sub-Critical Advanced Burner Reactors with a D-T Fusion Tokamak Neutron Source for the Transmutation of Spent Nuclear Fuel," *J. Fusion Energy* 38, 328 (2009).

Transmutation Fuel Cycle Analyses

13. E. A. Hoffman and W. M. Stacey, "Comparative Fuel Cycle Analysis of Critical and Subcritical Fast Reactor Transmutation Systems," *Nuclear Technol.* 144, 83 (2003).
14. J. W. Maddox and W. M. Stacey, "Fuel Cycle Analysis of a Sub-Critical, Fast, He-Cooled Transmutation Reactor with a Fusion Neutron Source," *Nuclear Technol.* 158, 94 (2007).
15. C. M. Sommer, W. M. Stacey and B. Petrovic, "Fuel Cycle Analysis of the SABR Subcritical Transmutation Reactor Concept," *Nuclear Technol.*, submitted (2009).

Dynamic Safety Analyses

16. T. S. Sumner, W. M. Stacey and S. M. Ghiaasiaan, "Dynamic Safety Analysis of the SABR Subcritical Transmutation Reactor Concept," *Nuclear Technol.*, submitted (2009).

4.3 Fusion-Fission Research Facility (FFRF) as a Practical Step Toward FFH (Leonid E. Zakharov [PPPL], Li Jiangang, Wu Yican [ASIPP, Hefei])

The FFRF ($R/a=4/1$ m/m, $I_{pl}=5$ MA, $B_{tor}=4$ T, $P_{DT}=50-100$ MW, $P_{fission}=80-4000$ MW) is a project of ASIPP, an institution working on the development of fusion applications to nuclear energy. *The mission of FFRF is to advance fusion to the level of a stationary neutron source and to create a technical, scientific, and technological basis for the use of high-energy fusion neutrons for the needs of nuclear energy and technology.* The aim is to launch the device in China in 12 to 15 years.

4.3.1 Mission and Reference Design Parameters

Within a year, a team now formed in ASIPP for the preconceptual design phase will make the final determination of the major design parameters of FFRF, such as the size of toroidal field coils (TFCs), plasma current, total fusion power, and space for the blanket based on its anticipated regimes.

The design of FFRF will rely as much as possible on ITER design. Thus, the magnetic system, especially the TFCs, will take advantage of ITER experience. The TFCs will use the same superconductor as ITER. The plasma regimes, on the other hand, will represent an extension of the stationary plasma regimes on HT-7 and EAST tokamaks at ASIPP.

Both pulsed inductive discharges and stationary noninductive lower hybrid current drive (LHCD) will be possible. FFRF strongly relies on the new lithium wall fusion (LiWF) plasma regimes, the development of which has already started and is anticipated to be completed within the next 5 to 7 years. This development will eliminate a number of uncertainties, which are unresolved in the ITER project.

The reference plasma parameters of FFRF are listed in Table 2.

Parameter	FFRF
D_{blanket} , m	1
a, R , m	1.0, 4.0
V_{pl} , m^3 , S_{pl} , m^2	150, 235
n_{20}	0.4
E_{NBI} , keV	120
$(\text{Ti}+\text{Te})/2$, keV	24
B_{tor} , T	4
I_{pl} , MA	5.2
P_{DT} , MW	50
W_{th} , MW	42
$\tau_{\text{E,ind}}$, $\tau_{\text{E,LHCD}}$, s	21.4-8.5, 2.0
P_{NBI} , P_{LHCD} , MW	2-5, 20
$Q_{\text{DT,ind}}$, $Q_{\text{DT,LHCD}}$	25-10, 2

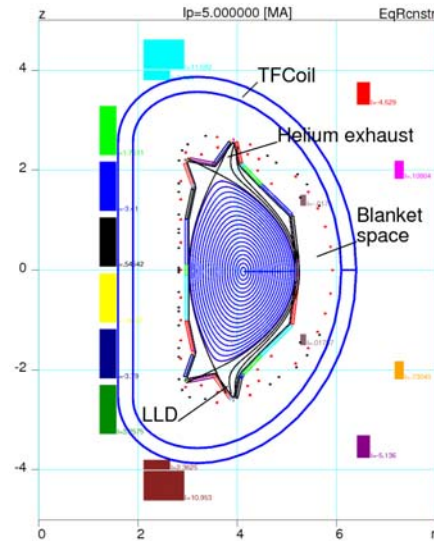

Table 2. Reference plasma parameters for FFRF.

Active core power is 80 to 4000 MW. Only thermal neutron regimes have been analyzed so far.

The magnetic system, based on the ITER superconductor, would be capable of a toroidal magnetic field of up to 6–7 T, higher than the reference field of 4 T. In parallel with progress in core plasma fueling, advanced plasma regimes of FFRF with a higher plasma density and fusion power of up to 100 MW could be possible at a later stage of FFRF without enhancement in the total plasma current. The increased magnetic field also could be used in the reference regime for enhancing cyclotron radiation and cooling the electrons in order to enhance the fusion-producing fraction of the beta parameter.

Even with reduction in requirements on plasma performance of FFH, it is still necessary to make significant progress in fusion plasma R&D. Analysis of ITER experience with its anticipated but never realized reliance on “well-established understanding” of plasma physics and fusion technology has led to a different approach adopted in FFRF.

While the technology and engineering design decisions will follow existing experience, including ITER, FFRH relies on new LiWF plasma regimes, which will be developed within 5 to 7 years in parallel with the conceptual and technical design phases.

In contrast to the currently dominant approach to fusion, LiWF regimes prevent plasma cooling by pumping all plasma particles using the lithium-covered surfaces and eliminating the recycling.

Prevention of cooling is much more efficient than reliance on extra heating (including alpha particle heating in ITER). Resulting LiWF regimes are much more consistent with stringent requirements on plasma control in a fusion device with a fission blanket core. These regimes should exhibit high edge plasma temperature, absence of temperature gradient turbulence, reduced energy losses from the plasma, and enhanced core and edge stability (absence of ELMs and associated peaked thermal loads on the plasma-facing components, absence of sawtooth oscillations, etc). They also permit the use of the entire volume for fusion power production, stationary regime in terms of noninductive current drive, and plasma-wall interaction. High plasma temperature and reduced density are consistent with the noninductive LHCD. Because of innovative plasma regimes, FFRF has a very appealing fusion mission.

So far, there has been no single failure of LiWF theory in prediction of relevant experimental results on CDX-U, NSTX (PPPL), DIII-D (GA), and FTU (Frascati).

Fusion mission and milestones:

1. Achieve ignition level performance in DD plasma $\langle p \rangle \tau_E = 1$ (which is the ignition condition in the alpha-heated plasma) in both inductive and LHCD regime
2. Achieve the rate of low-density He pumping consistent with the LiWall fusion regime
3. Demonstrate a short (about 1 min) ignition and long-lasting (fraction of an hour) $Q_{DT} > 20$ in an inductively driven current regime
4. Obtain long-lasting (hours), or stationary, externally controlled, stable plasma regime with noninductive (LHCD) current drive and $P_{DT} = 50$ MW

With its fusion mission, FFRH will represent a substantial step in non-fission fusion (nFF), parallel and complementary to ITER and consistent with the ongoing world fusion program.

4.3.2 Fusion-Fission Mission

At this time, it is not possible to realistically specify a definite mission (such as waste transmutation, fuel production, control of a subcritical active fission core) for a fusion-fission hybrid, which would lead either to a solution of some problems in nuclear energy or to a better approach to these problems compared to existing approaches not involving fusion. Neither fusion nor related blanket technology and the tritium cycle are ready to offer this kind of certainty.

In this regard the FFRF, as a research facility, represents a necessary step for discovering the means of merging the energetic neutron spectrum from fusion plasma with a variety of fission blanket compositions and regimes.

Fusion-driven nuclear blanket mission and milestones:

1. Integrate toroidal plasma with a full-size (1–1.5 m) fission blanket

2. Develop remote handling of blanket modules situated inside the toroidal magnetic field
3. Safely operate blankets with different content of fissile (nuclear waste) materials at nuclear power in the range 80–4000 MW and $k_{\text{eff}} < 0.95$
4. Operate different kinds of blankets in toroidal sectors of FFRF simultaneously
5. Breed tritium with the use of both fusion and fission neutrons
6. Determine practical limits on the helium-cooled version of blanket
7. Use both fusion and fission neutrons for component testing (CTF) for the purpose of fusion development

Use of a fast-fission neutron spectrum regime would be a significant enhancement in the mission of FFRF.

4.3.3 Timetable for FFRF

The development of a timetable for the implementation of the FFRF project is one of the goals of the one-year preconceptual design phase. The reference timetable given in Table 3 assumes close collaboration between the U.S. and Chinese fusion programs.

The timetable assumes a gradual development of FFRF plasma regimes on existing devices, including LTX, NSTX, HT-7, and EAST. In particular, the NSTX device in PPPL is a frontrunner in developing the LiWF plasma regimes. The FFRF project makes the NSTX program synchronous with the strategic goal of developing advanced regimes for both an ST-based neutron source for nFF and for stationary plasma in the EAST device. While U.S. devices can determine all the necessary conditions for the LiWF regimes, the Chinese devices HT-7 and EAST can implement the stationary version of these with the flowing liquid lithium plasma-facing target plates. Demonstration of LiWF plasma on EAST will be the final step to FFRF.

While the design of the tokamak core itself does not represent significant challenges, substantial R&D is necessary for Li technology, stationary NBI compatible with the neutron flux, low-density helium pumping, alpha-particle handling technology, and all technologies associated with remote blanket handling inside the toroidal magnetic field of a tokamak.

4.3.4 U.S.-China Cooperation

FFRF is uniquely consistent with the current nFF program in the United States and China, as well as with other FFH ideas:

1. During the first two decades of design and operation, FFRF has essentially represented a fusion facility, which can be considered a backup for ITER. Being complementary in mission to ITER and parallel in time, FFRF relies on the LiWF regime, which promises much more reliable plasma operation, relevant to both controlled magnetic fusion and FFH.

Project	2010	11	12	13	14	15	16	17	18	19	20	21	22	23	24	25	26	27	28	29	30
FFRF	pre-CD	CD, TD				Go ahead			Assembly			DD $p\tau_E=1$			DT, Ignition			FFH			
TFCoils	size, N	TD				Manufact.			Assembly			4-6 T						FFH			
Vvessel		CD		TD		Manufact			Assembly		LLD	HeP	αP			FFH					
PFC		CD		TD		Manufact			Assembly		LLD	HeP	αP			FFH					
Control		CD		TD		Manufact			Assembly		LLD	HeP	αP			FFH					
Blanket	CD								TD			Manufact		Assembly		FFH					
NSTX	LLD1	LLD2 $\tau_E=0.25$		Upgrade		LiWF regime															
HT-7	Li tray	LLL		gradual implementation of FLLL																	
EAST	0.5 MA	1 MA		NBI			Flowing LLD		HeP		Simulation of FFRF										
ST1				CD		TD		Manufact		Assembly		LLD	LiWF	DD $p\tau_E=1$							
NBI	CD long pulse 120 keV				TD and stationary 120 keV NBI																
FLLL	Demo	FLLL		FLLL for HT-7			FLLD for EAST			FLLD for FFRF											
HeP		CD		TD		HeP for EAST			HeP for FFRF												

Abbreviations used in the TimeTable

CD	Conceptual design
TD	Technical design
DD	Deuterium phase
DT	Deuterium-Tritium phase
HeP	Pumping low density helium
αP	Handling α -particle losses from the plasma
LLL	Liquid Lithium Limiter
FLLL	Flowing Liquid Lithium Limiter
LLD	Liquid Lithium Divertor
FLLD	Flowing Liquid Lithium Divertor
PFC	Plasma Facing Components

Table 3. Reference timetable for FFRF.

- FFRF stimulates the development of LiWF plasma regimes on the NSTX facility in the PPPL. Besides FFRF needs, this automatically serves two additional purposes: development of an ST-based neutron source as CTF for nFF, and development of the compact fusion neutron source (CFNS), suggested earlier for nuclear waste transmutation.
- During its operation as a research facility for fusion-fission, FFRF will provide the basic data for variety of possible technologies using high-energy fusion neutrons for nuclear energy, as well as fission neutrons for testing fusion reactor blanket components.
- For both non-fission fusion and fusion-fission, FFRF will be the first device that will develop the tritium cycle technology.

The entire FFRF project can potentially be realized as a Chinese national program. Nevertheless, with strong collaboration with the United States in both design and operation phases, FFRF could be launched on schedule and would serve the interests of both countries.

4.4 Fusion Driver for a Fusion-Fission Hybrid (The University of Texas group, August 30, 2009)

The main guiding principles and essential characteristics of the tokamak-based high-power-density CFNS (the fusion driver for a fusion-fission hybrid), first proposed by the University of Texas team and then discussed and “examined” by a variety of experts spanning various universities and national laboratories, can be summarized as follows:

1. The CFNS is designed to produce fusion power on the order of 50 to 100 MW.
2. The CFNS must be compact in order to fit inside a subcritical fast-fission assembly as a remotely handled, replaceable module. Compatibility with economical fission assemblies (using the technology being developed in the DOE Fast Reactor program) requires the CFNS plasma to have a major radius plus minor radius less than 2.5 m.
3. A tokamak with an aspect ratio (A) on the lower range ($1.6 < A < 2.5$) is chosen for the CFNS because such a conceptualized machine captures the best combination of physics basis, ease of coupling to a fission assembly, potential for high power density, and ease of maintenance. Two reference conceptual configurations with $A=1.8$ and $A=2.5$ (Figure 3), explored with Monte Carlo N-particle eXtended (MCNPX) fission calculations, are displayed along with Table 4, giving the nominal parameters of the fusion cores.
4. The optimum value of the aspect ratio remains to be determined; coupling to a fission blanket and maintenance advantages improve with lower A , but some aspects of the physics may favor higher A . Normal A tokamaks ($A \sim 3$), have a very substantial multi-machine experimental basis for projecting to thermonuclear conditions. For $A < 2$ (the spherical tokamak, ST), the physics may change somewhat, but nonetheless there is substantial commonality with normal A . Also, the ST experimental basis will be greatly expanded by upgrades of the mega-ampere class ST devices NSTX and MAST.
5. A substantial theoretical basis and computational tool set has been developed for thermonuclear level tokamaks as a prelude to ITER; this powerful machinery can be harnessed for STs as well.

Attempts to construct a neutron source of this power and compactness would have been impossible without the impressive achievements of the worldwide fusion research. Two recent innovations, however, were necessary for the reference architectural design of the CFNS.

1. A new magnetic divertor geometry, the Super-X divertor (SXD) (Fig. 4) with power exhaust capacity boosted by a factor of ~ 5 (over conventional alternatives), is able to withstand the enormous heat fluxes anticipated in a CFNS. The Super-X divertor pulls the divertor plasma channel to a large radius where the heat flux naturally decreases and spreads onto a larger area: the plasma cools and its radiative capacity is enhanced over the standard divertors. *The SXD will allow the CFNS core plasma to operate in readily accessible, demonstrated, and conservative dimensionless parameter space (e.g., its normalized beta and H factor are similar to ITER).* By substantially shielding the highly stressed divertor components from neutrons as well

as heat, the SXD geometry is crucial in making near-term divertor technology adequate for CFNS design goals.

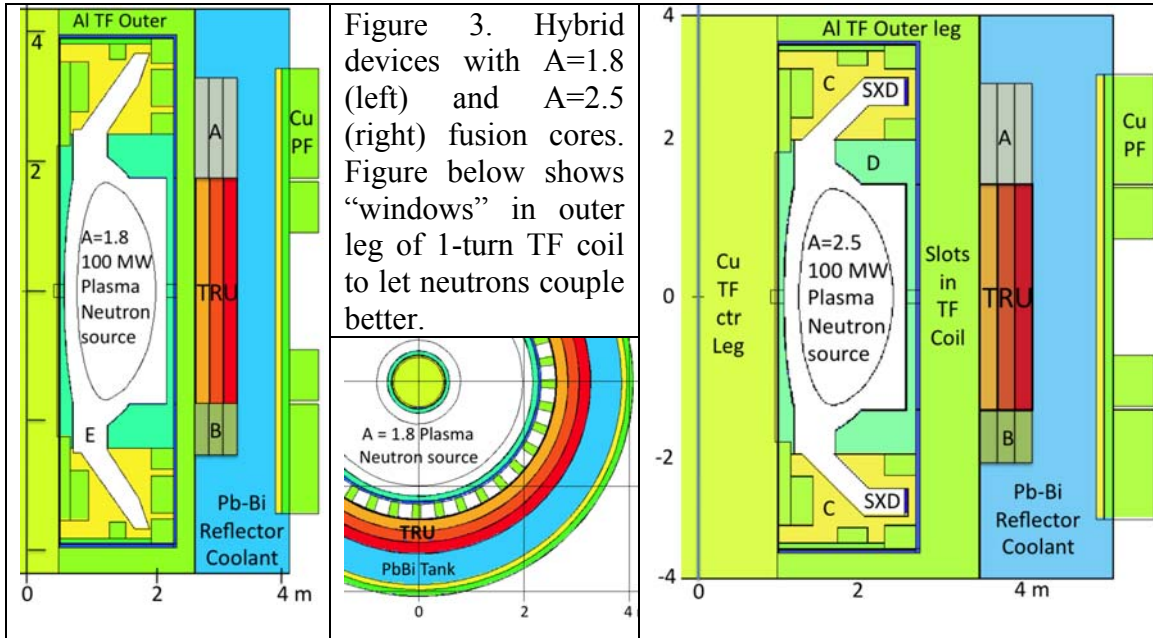

A	R (m)	κ	$\langle\beta\rangle_N$	β %	neutrons MW/m^2	n_e 10^{20}m^{-3}	n_e/n_G	P_{CD} (MW)	I_p MA	B_{Coil} T	B_{Plas} T
1.8	1.35	3	2.5	22	1.0	1.2	0.2	50	12	7	2.6
2.5	1.79	2.5	2.5	10	0.9	1.4	0.24	56	9	7	3.8

Table 4. Parameters for 100 MW CFNS fusion core for the two hybrid designs of Figure 3.

1. A new magnetic divertor geometry, the Super-X divertor (SXD) (Fig. 4) with power exhaust capacity boosted by a factor of ~ 5 (over conventional alternatives), is able to withstand the enormous heat fluxes anticipated in a CFNS. The Super-X divertor pulls the divertor plasma channel to a large radius where the heat flux naturally decreases and spreads onto a larger area: the plasma cools and its radiative capacity is enhanced over the standard divertors. *The SXD will allow the CFNS core plasma to operate in readily accessible, demonstrated, and conservative dimensionless parameter space (e.g., its normalized beta and H factor are similar to ITER).* By substantially shielding the highly stressed divertor components from neutrons as well as heat, the SXD geometry is crucial in making near-term divertor technology adequate for CFNS design goals.

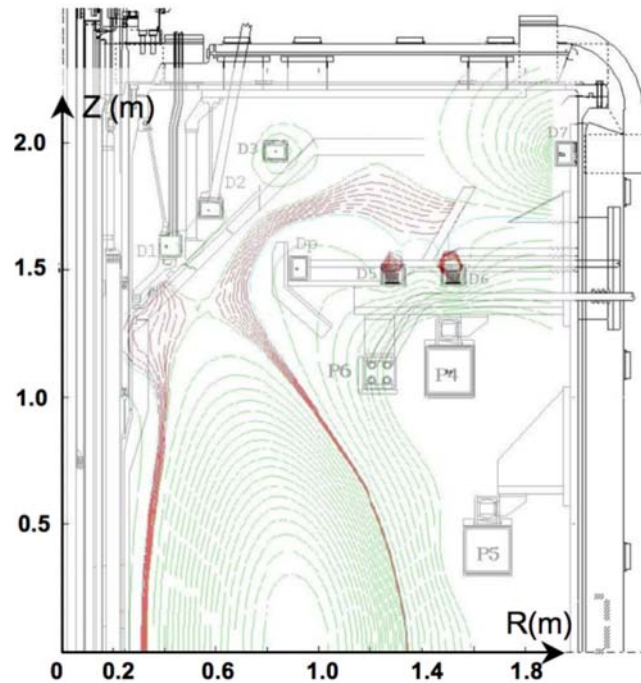

Figure 2. Super-X engineering design for MAST-upgrade

2. Because of its compactness, the CFNS can be designed as an independent *replaceable fusion module* that fits within a fission blanket but is *not physically connected to it*. This class of CFNS-driven hybrids, with fission blankets outside the toroidal magnetic field (TF) coils, is very different from the class of generic hybrids, where the fission blanket is an integral part of the fusion driver with everything located inside the TF coils. The replaceable module concept greatly minimizes the impact of several problematic issues that are bound to arise through the integration of fission with fusion. In addition, the replaceable fusion module concept greatly reduces the fusion technology requirements for the hybrid, and allows it to be developed much sooner than a pure fusion DEMO. Specifically:
 - a) The fusion driver may be (if needed) replaced at the same time the fission blanket is reshuffled — both maintenance operations can be carried out simultaneously in weeks. The replaceable option makes the material constraints much less stringent; the driver components, then, have to withstand exposure to fusion neutrons for only about 1 to 2 years compared to the approximately 5 years required for a conventional hybrid or a pure fusion reactor. Cumulative damage from the fusion neutrons at 14 MeV is greatly reduced to a level many times below the requirement for pure fusion power plants. Further, it greatly reduces the testing cycle time of the CFNS compared to other fusion applications — accelerating development and qualification by several times. A compact modular CFNS, unique to our approach, brings down the time for the realization of the hybrid driver to possibly 2 to 3 decades.
 - b) Placing the fission blanket outside the TF brings a two-orders-of-magnitude reduction in the impact of plasma transients on the fission blankets; the TF coil structure will act as an electromagnetic shield against disruptions, for instance.

- c) Placing the fission blanket outside the TF results in a huge reduction (2 to 3 orders of magnitude) in MHD drag forces on the liquid metal coolants in the high-power-density fission blanket, obeying stringent cooling requirements.
- d) The mechanical and electromagnetic decoupling of the fusion and the fission assemblies makes the “failures in the fusion driver” much less likely to propagate to the fission blanket, greatly reducing potential safety problems and licensing issues.
- e) The geometry of the fission blanket is qualitatively much closer to the geometry of FR designs — fuel rods with axial coolant flow. Thus the proposed hybrid assembly can maximally utilize the technology developed for the FR program, thereby reducing the time for the realization of the hybrid.

Our attempts to create maximum compatibility between the fusion and fission assemblies ends up dictating crucial aspects of the designs for the fusion module itself — for instance, the choice of the best current drive modes in the CFNS. Since the penetrations of the fission blanket must be avoided for safety and “complexity” reasons and for facilitating easy removal of the module, neutral beams do not remain an attractive option for heating and current drive; RF current drive becomes highly desirable. Preliminary investigations indicate that methods based on electron-cyclotron current drive appear to have adequate efficiency. Fast wave-based current drive is another possibility that has to be explored. A rather limited amount of neutral-beam current drive may be possible, if it is found to be indispensable.

The science and technology needed for a CFNS has a great deal of overlap with research and development planned for CTF, a component test facility for a pure fusion reactor. Although the development stages for the two are quite similar, the most time-consuming stages in the CTF mission can become much shorter because the neutron fluence requirement is much lower for the replaceable CFNS module. Logical stages in the development of a CFNS/CTF program are as follows:

1. Plasma break-in stage. Developing pulse lengths up to weeks in H and then in D. In this phase one establishes the reliability of plasma support and control systems and delineates, for later D-T operation, the operating regime in which the probability of disruptions is extremely low. Evolution of plasma-facing surfaces on plasma bombardment during long pulse may be studied, leading to the development and testing of suitable plasma-facing components. The effects of surface heat fluxes, magnetic fields, and occasional disruptions on components, including actively cooled components with rapid coolant flow, are examined. Remote maintenance procedures are tested in a low-radiation environment, since hands-on maintenance is still possible in the event of surprises. Much of this work might be carried out on a more extensive NSTX upgrade, for example.
2. Low-fluence DT operation, $0.1\text{--}0.3\text{ MW yr/m}^2$. Such a device requires full remote maintenance. Issues of tritium permeation and retention are examined. Tritium breeding, processing, and fueling are tested. Effects of a high-energy alphasparticle population in the plasma are examined, and operating modes may be modified to account for their effects. Initial examinations of 14 MeV neutron

effects in the integrated fusion environment, including development of radiation-resistant diagnostics and test methods, would be carried out. Structural material modifications are expected to be small in this stage.

3. Moderate-fluence operation ($1\text{--}3\text{ MW yr/m}^2$). Structural material modifications become significant but are not expected to be unmanageably large. In this step reliable component designs, consistent with these modifications, are to be developed. In the University of Texas proposal, the completion of this stage announces the readiness for operating a CFNS for hybrid applications.
4. High-fluence testing ($4\text{--}6\text{ MW/m}^2$). Large changes in structural materials are expected, and development of reliable components under these conditions may prove challenging, involving long testing times, possibly with multiple iterations. This time-consuming step will be a necessary part of the CTF/pure fusion mission.

What makes the UT hybrid proposal a relatively near-term enterprise is that *the last stage is not required for hybrid operation and hence for the CFNS mission*. The replaceable module concept ensures that components may be, if needed, replaced at $1\text{--}3\text{ MWyr/m}^2$ — before severe structural changes are expected to occur. For a pure fusion DEMO, on the other hand, the last step is regarded as *crucial* for satisfactory operation. This last stage is the most time consuming, because attaining such large fluences will require considerable operating time (many years). It is reasonably likely that the initial design of some components will require modification to enable reliable operation with large changes in material properties at this stage. After such a redesign, the new components must be subjected to high fluence again to test and to verify the efficacy of the design change. Such a process could take several iterations before a dependable component system (with sufficient error margins) can emerge. Each of the iterations for the CTF mission (step 4) will take a long time. For the CFNS mission too, there may be several iterations, but each iteration (step 3) will consume much less time, and the challenges due to material modifications will be considerably less, imparting near-term feasibility to the project.

Of course, after hybrids have been shown to work, it would incrementally assist hybrid operation to have components with longer lifetimes (with lower component replacement costs, less maintenance down time, and so on). This capability would, however, develop as part of an evolutionary progress peculiar to any complex technical-industrial enterprise. The important thing to note is that a workable hybrid system can be put together on time scales much shorter than a pure fusion application can; for the latter, step 4 is a prerequisite to initial operation.

After the CFNS has reached satisfactory reliability and availability for initial hybrid operation, a fission assembly with fissionable fuel could be added outside the CFNS. Prior to this step, fission test modules without fissionable fuel will have been subjected to thermo-hydraulic tests in the presence of a magnetic field, tests of disruption resilience of fuel/support assemblies, and initial corrosion lifetime testing. As the final step, rods loaded with transuranic fuel, based on technologies developed as part of the fast reactor program, would be subjected to neutron-damage testing, full thermo-hydraulic testing, and corrosion lifetime testing,

A critical fast reactor could be used for initial testing and for development of the fission components, concurrent with stages 1 through 3 outlined above. However, a significantly different isotopic mixture would have to be used, because of unacceptable stability of the hybrid isotopic mixture in a critical fast reactor. The fuel would likely be chemically and physically similar to the hybrid fuel. Simultaneous with the development of the CFNS, other fuel cycling technologies will have to be developed (such as reprocessing, remote fuel fabrication, and fuel transport).

References (the University of Texas spherical tokamak proposal)

1. M. Kotschenreuther, P. Valanju, S. M. Mahajan, and E. Schneider, "Fusion–Fission Transmutation Scheme - Efficient destruction of nuclear waste," *Fus. Eng. Des.* 84, 83-88 (2008).
2. P. Valanju, M. Kotschenreuther, and S. Mahajan, "Super-X Divertors and high power density fusion devices," invited talk at 2008 APS Division of Plasma Physics Annual Meeting, *Phys. Plasmas* 16, 056110 (2009).
3. P. Valanju, M. Kotschenreuther, and S. M. Mahajan, "Super X Divertors for solving heat and neutron flux problems of fusion devices," *Fus. Eng. Des.* in press, available on web from July 2009.
4. M. Kotschenreuther, P. Valanju, S. Mahajan, L. J. Zheng, L. D. Pearlstein, R. H. Bulmer, J. Canik, and R. Maingi, "The Super X Divertor (SXD) and High Power Density Experiment (HPDX)," 2008 IAEA Fusion Energy Conference, Geneva, Switzerland, 13-18 October 2008, paper IC/P4-7.
5. J. M. Canik R. Maingi, L. Owen, J. Menard, R. Goldston, M. Kotschenreuther, S. Mahajan, P. Valanju. "2D Divertor Design Calculations for the National High-Power Advanced Torus Experiment," *J. Nuclear Materials*, in press (2009).
6. R. J. Goldston, J. Menard, J. Canik, M. Kotschenreuther, S. M. Mahajan, P. Valanju, et al., "An experiment to tame the plasma-material interface," 18th International Conference on Plasma-Surface Interactions in Controlled Fusion Devices, Toledo, Spain, 26-30 May 2008, paper P3-94.
7. S. Lisgo, M. Istenic, R. Buttery, J. M. Canik, I. Katramados, M. Kotschenreuther, M. Kovari, S. M. Mahajan, M. Shannon, D. Taylor, P. M. Valanju, and the MAST Team, "Super-X advanced divertor design for MAST Upgrade," talk presented at the 2009 European Physical Society Conference on Plasma Physics (29 June-3 July 2009, Sofia, Bulgaria).
8. Y. K. M. Peng, J. M. Canik, W. D. Dorland, L. Grisham, D. L. Hillis, M. Kotschenreuther, R. LaHaye, S. Mahajan, R. Majeski, S. Sabbagh, P. Valanju, et al., "Extensive remote handling and conservative plasma conditions to enable fusion nuclear science R&D using a component testing facility," 2008 IAEA Fusion Energy Conference, Geneva, Switzerland, 13-18 October 2008, paper FT/P3-14.

4.5 The Reversed-Field Pinch as a Neutron Source for Fusion-Fission Hybrid Applications (G. Fiksel, J.S. Sarff, and MST Group, University of Wisconsin-Madison; A.A. Ivanov and V.I. Davydenko, Budker Institute of Nuclear Physics, Novosibirsk, Russia)

The reversed-field pinch (RFP) toroidal magnetic configuration could provide a relatively simple neutron source for fusion-fission hybrid (FFH) applications. The RFP is axisymmetric, like the tokamak, but current in the plasma primarily generates the magnetic field. In particular, the applied toroidal magnetic field is more than an order of magnitude smaller than for a tokamak.

The features of the RFP that are advantageous for pure fusion also make it an interesting candidate for an FFH driver. In particular, the beta value for the RFP is high, especially the engineering beta, defined using the maximum magnetic field pressure at the magnets. Engineering beta of approximately 25% has already been demonstrated in present-day experiments¹, and the upper limit is yet to be determined. As for a pure-fusion RFP reactor, normal magnet technology would be allowed for FFH application, with even less-demanding requirements. Normal magnets operated at low field strength would help minimize device size, reduce magnet power consumption, and promote reliability. The larger ohmic heating in the RFP reduces or possibly eliminates the need for auxiliary heating using complex plasma-facing power injection systems. This feature would be especially advantageous in an FFH, where access is likely to be more limited than for a pure fusion system. Efficient, steady-state sustainment of the plasma current may be possible using AC magnetic helicity injection and magnetic self-organization; the impact of magnetic turbulence on energy confinement may be less of an issue for the reduced fusion power requirements in FFH. The RFP's high beta and low field advantages were confirmed in the TITAN fusion system study², albeit with a large extrapolation from the established RFP database.

While the scientific development of the RFP is less mature than for the tokamak, substantial progress has been made in recent years. Reduction of magnetic fluctuation-induced transport has been demonstrated using current profile control, yielding confinement close to that of a same-size, same-current tokamak³. Reduction in magnetic turbulence is also appearing in spontaneous quasi-single-helicity conditions as the plasma current is increased⁴. Active control of multiple resistive wall modes is now routine, a critical development since RFP plasmas require such control even at low beta⁵. Power and particle handling at the plasma boundary interface is relatively immature for the RFP.

The relative tradeoffs in physics and engineering embodied in the various magnetic configurations are important to understand in regard to optimizing fusion applications. However, a substantial investigation of the RFP as a neutron source for FFH has not been undertaken. To help expose the potential benefits offered by the RFP, an example neutral-beam-driven system based on parameters close to those established in the RFP experiment is presented that yields a neutron source rate of $\sim 3 \times 10^{18}$ n/s, relevant to transuranic waste burning requirements. The parameters in Table 5 compare favorably with proposals based on other approaches to achieve similar neutron source rates. The

RFP could also make a relatively compact system with substantial thermal neutron production, but the extrapolation in plasma performance is substantially larger.

4.5.1 Example Neutral-Beam-Driven RFP Neutron Source

The plasma parameters for an example NBI-driven neutron source are shown in Table 5. The assumed bulk plasma parameters are close to those established in present-day RFP experiments (MST and RFX devices). In particular, note the relatively low values for the field at the magnets. The bulk thermal plasma is assumed to be tritium, and the injected ions are deuterons. To maximize the neutron production, the neutral beam source energy is 140 keV. The fast ions are assumed to slow down classically, yielding a neutron rate that depends principally on the electron temperature, dN/dt [n/s] $\approx 8 \times 10^{16} P_{inj}$ [MW] $T_e^{3/2}$ [keV]. An NBI power of 18 MW yields a fast ion pressure with $\beta_{fi} = 30\%$. The combined fast ion and thermal beta is only modestly larger than the achieved thermal value. The assumed thermal energy confinement time is comparable to the values obtained in high current RFP plasmas undergoing magnetic self-organization, and 2 times less than the transient maximum values obtained using current profile control.

Plasma current, $I_p = 2$ MA	Neutron production, $dN/dt = 2.6 \times 10^{18}$ n/s
Major/minor radii, $R = 1.5$ m, $a = 0.5$ m	Neutral beam power, $P_{inj} = 18$ MW
Electron temperature, $T_e = 1.5$ keV	Fusion power, $P_f = 7.3$ MW
Bulk ion temperature, $T_i = 0.5$ keV	Ohmic power, $P_\Omega = 8$ MW ($Z_\Omega = 2.4$)
Electron density, $n = 4 \times 10^{19}$ m ⁻³ ($n/n_G = 0.16$)	Fusion gain, $Q = 0.3$
Thermal energy confinement time, $t_E = 5.5$ ms	Neutron load, $P_n = 0.2$ MW/m ²
Magnetic field on axis, $B(0) = 1.9$ T	Avg. heat load, $P_w = 0.9$ MW/m ²
Max. field at B_p magnet, $< B_p(a) = 0.8$ T	Fast ion beta, $\beta_{fi} = 2\mu_0 \langle p_{fi} \rangle / B(a)^2 = 30\%$
Max. field at B_T magnet, $B_T(a) = 0.2$ T	Thermal beta, $\beta_{th} = 2\mu_0 n (T_e + T_i) / B(a)^2 = 6\%$
Lundquist number, $S = \tau_R / t_A = 6 \times 10^7$	Fast ion gyroradius, $r_{fi}/a \leq 0.13$

Table 5. Neutral-beam-driven RFP neutron source.

4.5.2 Status of Scientific Issues for the RFP

Energy confinement: The dominant loss mechanism in RFP plasmas undergoing magnetic self-organization is stochastic magnetic transport. As the plasma current has been increased recently, spontaneous quasi-single-helicity equilibria appear with reduced magnetic fluctuations and improved confinement (parameters close to those in Table 4)⁴. With current profile control, confinement is yet larger, comparable to that for a same-size, same-current tokamak³. The role of electrostatic turbulence remains to be determined, and confinement scaling is not well established.

Fast ion confinement: Short-pulse NBI experiments at 30 keV (small fast ion population) have demonstrated that energetic ion confinement in the RFP is close to classical, even with substantial magnetic stochasticity⁶. This is understood as being due to decoupling of the fast ion orbits from the magnetic field. At lower energy, the slowed ions re-couple to the magnetic field, and stochastic transport might actually be useful for removing ash. New, longer-pulse MW-level injectors being prepared for MST and RFX will in the near term examine fast ion confinement and plasma stability, e.g., Alfvén eigenmodes, with a larger population of fast ions.

Current sustainment: Efficient, steady-state current sustainment is possible using AC magnetic helicity injection (oscillating field current drive, OFCD), an inductive current-drive method that avoids magnetizing flux accumulation through the use of AC loop voltages. The theoretical physics basis for the OFCD magnetic self-organization process is similar to that for the standard RFP with steady toroidal induction⁷. OFCD experiments have so far produced 10% current drive⁸. A large Lundquist number ($S > 10^7$) is required for 100% OFCD to avoid large AC equilibrium modulation.

Resistive wall mode control: The RFP requires a conducting shell for stability to current-driven kink modes. Control of multiple resistive wall modes is now routine using active feedback strategies⁵. The optimum control remains to be determined, especially in a fusion environment.

Beta limit: High beta values have been obtained, but the physics that determines the limit is not known. The ideal MHD limit (with conducting shell) is $> 50\%$, depending on equilibrium details.

Density limit: RFP plasmas empirically exhibit a density limit comparable to the Greenwald value^{1,9} but the physics underlying the limit remains to be determined.

Boundary control: Power and particle control are not well developed for the RFP. MST and RFX are both circular, with simple limiters. Control techniques such as toroidal divertors and highly radiative plasmas need to be tested and developed.

4.5.3 Timeline and Next Steps

The principal next-step challenge for the RFP is to demonstrate good confinement, sustained for long periods of time. It is also necessary to integrate boundary control. A next-step experiment with 2–4 MA plasma current capability is required to demonstrate confinement scaling and to test full sustainment by OFCD. One option would be an upgradable facility that focuses first on confinement and sustainment, and then later integrates boundary control. In this way the basis for a burning plasma step could be established more quickly, and possibly with lower overall cost. Generic advances in fusion engineering that are likely to occur on a similar time scale, so that the physics and

technology basis for an RFP neutron source for FFH or other applications could be established within the next two decades.

References (the reversed-field pinch for hybrids)

1. M.D. Wyman, B.E. Chapman, J.W. Ahn, et al., Nucl. Fusion 49, 015003 (2009).
2. F. Najmabadi, R.W. Conn, R. A. Krakowski et al., Fusion Eng. Des. 23, 69 (1993).
3. J.S. Sarff, A.F. Almagri, J.K. Anderson et al., Nucl. Fusion 43, 1684 (2003).
4. R. Lorenzini, E. Martines, P. Piovesan et al., Nature Physics 5, 570 (2009).
5. T. Bolzonella, V. Igochine, S.C. Guo et al., Phys. Rev. Lett. 101, 165003 (2008).
6. G. Fiksel, B. Hudson, D.J. Den Hartog et al., Phys. Rev. Lett. 95, 125001 (2005).
7. F. Ebrahimi, S.C. Prager, J.S. Sarff, J.C. Wright, Phys. Plasmas 10, 999 (2003).
8. K.J. McCollam, A.P. Blair, S.C. Prager, J.S. Sarff, Phys. Rev. Lett. 96, 035003 (2006).
9. M.E. Puiatti, P. Scarin, G. Spizzo et al., Phys. Plasmas 16, 012505 (2009).

4.6 The Stellarator

The stellarator is a magnetic confinement toroidal fusion system that looks very similar to a tokamak from a distance and is best described by comparison to the tokamak. The major structural difference is that a tokamak is axisymmetric, while the stellarator lacks symmetry entirely. Plasma confinement in a tokamak requires that there be a net plasma current in the toroidal direction, and in all its incarnations a significant fraction of this current must be externally driven. Plasma confinement in a stellarator comes from the non-toroidally symmetric external magnetic fields, and no external current drive may be necessary to create the equilibrium. For the most part the tokamak plasma lifetime has been limited by the temporal limitation on the ability to drive a plasma current, but there is no reason to believe there is an intrinsic limitation on the plasma lifetime. The tokamak coils, being axisymmetric, are far simpler to build than the intricate sets of stellarator coils, although there have been large numbers of stellarators successfully built and operated. At present, the Large Helical Device (LHD) in Japan is the largest and most successful stellarator in the world, with plasma lifetimes on the order of an hour, and plasma beta exceeding 4%. W7-X, another large stellarator, is under construction in Germany and is expected to start operation in four or five years.

The observation that from a distance a stellarator looks much like a tokamak leads to the belief that one should be able to carry over much of the reactor design work from tokamaks to stellarators, and that blankets that work in one design should work in the other. Although there have been a number of more detailed stellarator reactor designs, there is a good deal of necessary additional work. There has been no major effort on hybrid stellarator design. It is expected that the general outlines of a tokamak design would be an adequate first step for a stellarator.

The fact that the stellarator lacks any exact spatial symmetry opens the possibility for many extremely different stellarator designs. In low collisionality systems, good plasma confinement requires that the magnetic field be approximately quasi-symmetric; that is, that the magnitude of the magnetic field possesses some symmetry, whether toroidal, axial, or helical. The full configuration, however, lacks any such symmetry. The United

States started the construction of a relatively low-aspect-ratio quasi-axisymmetric stellarator. However, cost overruns led to the cancellation of the project. The only extant quasi-symmetric stellarator in the world is a large-aspect-ratio quasi-helically symmetric device at the University of Wisconsin. The W7-X stellarator may be able to operate as a quasi-symmetric system. At present there is no understanding of what a “best” stellarator might be, however one might choose to interpret the word best.

It should be noted that both LHD and W7-X are large-aspect-ratio devices, and that one possible fusion hybrid based on the stellarator would be a moderate-collisionality, high-density, relatively low-temperature scale-up of LHD. That scaling of LHD would approximately double its dimensions. Stellarators appear not to be subject to disruptions and ELMs, but divertor design and energy and particle exhaust issues are not well understood. The beta limit of stellarators also is not understood, but all the experimental evidence is that adequate values of beta, higher than 5%, are possible. The possibility of a magnetic fusion system with a natural steady state, good energy confinement, and good stability properties makes the stellarator a serious candidate for hybrid development. In this endeavor, the United States would be heavily dependent on work from outside this country, and intense research and development would be necessary. Any development activity would, of necessity, require extensive engineering and fabrication studies as well as plasma physics research. Systems studies would be needed to select aspect ratio, density, temperature, fuel cycles, and so on for a stellarator of interest for a hybrid.

4.7 Axisymmetric Mirror as a Neutron Source, a Hybrid, and a Pure-Fusion Reactor (R.W. Moir, A.W. Molvik, D.D. Ryutov, T.C. Simonen, Lawrence Livermore National Laboratory, Livermore, CA 94550)

4.7.1 Introduction

Mirrors have a number of attractive features as future fusion devices: they have simple linear geometry to ease construction and maintenance, are inherently steady state and operate at high beta, have no externally driven currents, and have natural divertors to handle heat loads external to the magnet system.

Over the past decades, largely after the termination of the mirror program in the United States, several techniques have been suggested for making mirrors stable in axisymmetric geometry. The attractive features of mirrors are tremendously amplified in the case of axial symmetry. In particular, neoclassical and resonant transport are completely eliminated; engineering simplicity and general flexibility of the device increase significantly; and much higher magnetic fields become available for mirror throats. Axisymmetry is thus a game-changer in mirror systems.

4.7.2 Experimental Progress

One particular technique for making MHD-stable axisymmetric mirrors has been thoroughly investigated with the Gas-Dynamic Trap facility at Novosibirsk (Figure 5),

where stabilization was provided by the exhaust plasma in the favorable magnetic curvature of end tanks. The stability was further enhanced by creating a slow azimuthal rotation by controlling the radial potential distribution. Doing so allowed achieving beta as high as 60% in a fully axisymmetric configuration¹.

At present it is clear that using sloshing ions — a technique pioneered by the TMX-U team at Livermore decades ago² — has a very strong favorable effect on plasma microstability. Indeed, on the GDT device the sloshing 10-keV ions behaved classically, with no signs of anomalous scattering at the ion density $5 \times 10^{19} \text{ m}^{-3}$ limited by the available injection power.

It was demonstrated that parallel electron heat loss in mirror systems can be reduced to a classical, quasi-neutrality-based limit (one lost electron per one lost ion) by using strong expansion of the magnetic flux in the end tanks and providing a good pumping of the recombined particles³. This issue has been assessed theoretically and has been explored in significant detail with the GDT facility. The radial transport in current experiments with axisymmetric mirrors has been typically very weak.

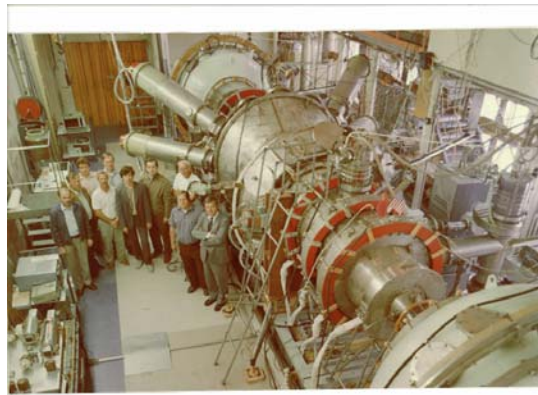

Figure 5. The GDT axisymmetric mirror at Novosibirsk. There are six neutral beam (NB) injectors tilted at 45 degrees with respect to the magnetic axis. Expansion tanks are seen at the front and back. The magnetic field in the solenoidal part is up to 0.3 T, and in the mirrors it is up to 15 T. This is a pulsed system, with an NB pulse length of 6 ms that exceeds the plasma characteristic times.

4.7.3 14 MeV Neutron Source

When combined, these three techniques lead to an attractive source of fusion neutrons for material and subcomponent testing of future hybrid systems and pure fusion reactors (including, for example, blanket cassettes). The source providing the flux of fusion neutrons up to 3 MW/m^2 over the test area of approximately 1 m^2 (cylindrical test zone with an internal diameter of approximately 30 cm and length of 1 to 1.5 m) can be built with minimum extrapolation from the existing experimental facility (see white paper by T. Simonen for details of a source with the flux of 1 MW/m^2). The availability of such a source is of paramount importance for developing fusion-fission hybrids, as it will allow testing of subcomponents of the blanket under conditions very similar to those to be met

in a real hybrid facility. Such a source is critical for obtaining information required for the licensing process for any version of a fusion-fission hybrid. Importantly, accumulating $10 \text{ MW}\cdot\text{yr}/\text{m}^2$ fluence requires consumption of only 700 g of tritium, thereby eliminating the need for tritium breeding in the source itself.

This source cannot be replaced by either a point-like accelerator-based neutron source (too small a volume and wrong neutron spectrum) or a full-blown fusion source based on other magnetic configurations (the need to breed tritium in order to accumulate any reasonable fluence). These other sources are desirable but cannot substitute for the mirror-based source.

Interestingly, if one does not want to make *any* extrapolations from the plasma parameters already obtained with the GDT device, one would be able to produce neutron flux on the order of $0.1 \text{ MW}/\text{m}^2$ by using the D-T mix. Although the basic version of the mirror source is steady state, one can also include the option of modulating the neutron flux at frequencies in the range of 1 Hz to 1 KHz, which could allow imitating some (though not all) aspects of rep-rate pulsed fusion engines.

Two workshops were convened to assess the physics basis and technological readiness of the mirror concept with favorable conclusions. The major development would be steady-state operation, common to all MFE concepts. The most challenging issues are related to steady-state neutral beam, fueling, and tritium systems. The smaller mirror system will be easier to construct and less costly than larger, more complex configurations. Several designs have been produced, including one for testing a large number of temperature-controlled specimens⁴. Other engineering work completed in the United States, Russia, and Germany will jump-start the development of a compact mirror-based neutron source.

4.7.4 Actinide Burner

Axisymmetric mirrors can serve as a driver for a modest-Q version of hybrid systems for actinide burning. The schemes that provide MHD stability for axisymmetric mirrors are not limited to stabilization by the outflowing plasma, GDT-style. They also include other approaches that may be better suited to systems with a better axial confinement than GDT. Combined with a simple mirror (not using tandem mirror end plugs) they can become a basis for a mirror facility with Q of approximately 1.5 which, because of its simple geometry, easy access to the plasma, and flexible dimensions can serve as a very attractive driver for hybrid systems.

A rough schematic of one version of such a driver is shown in Figure 6. Neutral beams (70 keV, absorbed beam power $\sim 100 \text{ MW}$) are injected to a magnetic field 1.41 times higher than the field in the solenoid, thereby creating a sloshing ion population. The electron temperature in the device is artificially held at a level much lower than the classically attainable one by the gas puff or low-energy NBI beyond the turning points of sloshing ions. For the version discussed here it is assumed that T_e is 4 keV. Because of a higher electron temperature (than in the neutron source), the ion slowing down time

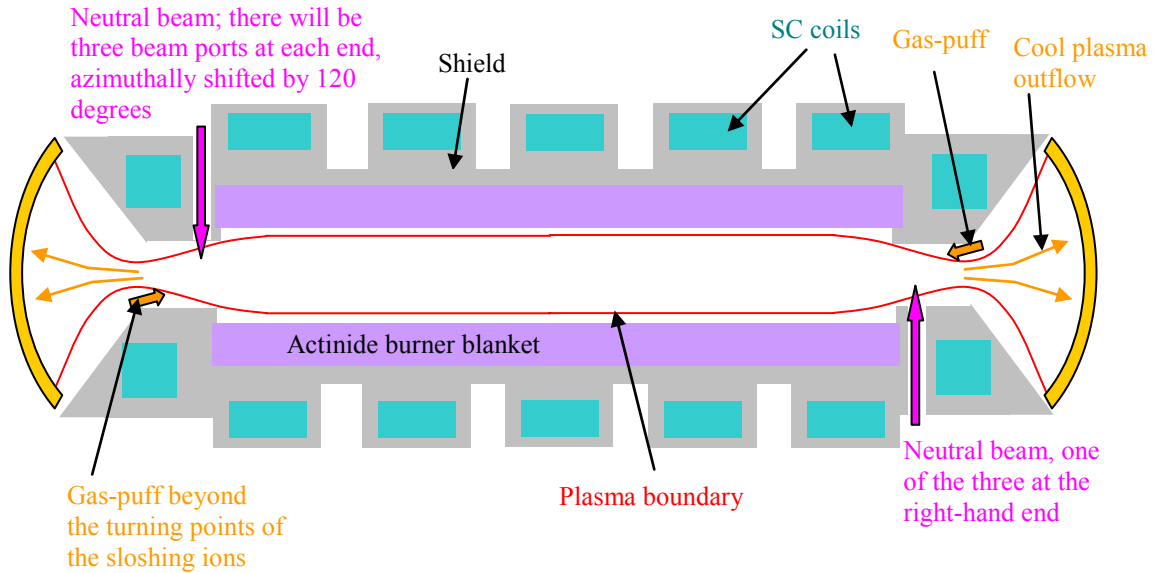

Figure 6. Main elements of the axisymmetric mirror driver for the actinide burner. The relative dimensions of the parts are not to scale. The neutron power per unit length is approximately 3 MW/m, with the first wall neutron flux approximately 1 MW/m².

increases, and the ion axial density distribution will not be strongly peaked near the turning points. Accordingly, the neutron production will be quasi-uniform along the device (up to the turning points, beyond which it drops sharply). The plasma density in the solenoid will be approximately 10^{20} m^{-3} . The plasma diameter in the solenoid is assumed to be 1 m, the mirror-to-mirror length 30 m, with a total system length of 50 m. The magnetic field in the solenoid will be 2.5 T, and 12 T in the mirrors (all superconducting). Field at the end wall can be less than 0.05 T. The end wall will be radially segmented to allow for imposition of a slow differential rotation that was shown to have a favorable effect on the axisymmetric MHD stability. The artificial cooling of the electron population brings the dimensionless parameters of this system closer to those obtained in the existing experiments.

4.7.5 Blanket for the Actinide Burner

Any of the tokamak or inertial fusion blanket designs can also be used on the mirror even more simply, owing to the modularity allowed by the long cylindrical geometry so long as the neutron wall load is similar. Each module (Figure 7) will have associated with it a first wall (<10 mm), a vacuum seal, a tritium breeding region, an actinide-burning region, a superconducting magnet, and heat transfer coolant lines. However, as with other fusion concepts the first wall must be cooled; most of the non-neutron power escapes out the

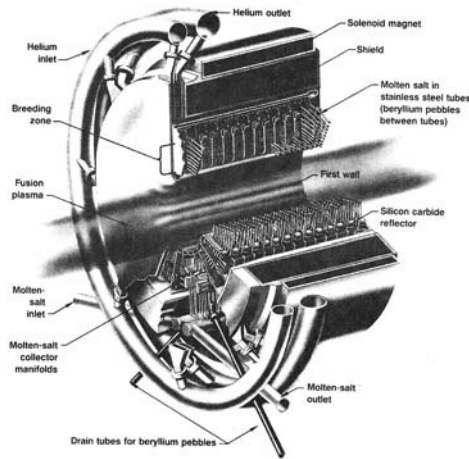

Figure 7. Module of a mirror actinide burner.

end where the power density on the wall can be reduced as much as necessary so the first wall heat load is lower than in toroidal systems. The lack of disruptions means a thinner first wall that aids better neutron economy.

Operating the actinide burner at Q of about 1 and still keeping recirculating power low enough (not to damage economics) may be achieved by developing and employing direct conversion of unneutralized beams to raise the injection efficiency to about 70%. Also developing and deploying direct conversion of end leakage can result in about 50% or somewhat more efficient conversion of the charged power.

4.7.6 Axisymmetric Mirror as a Pure-Fusion Device

To develop a mirror into an attractive pure-fusion reactor, one has to use ambipolar end plugs. As these plugs will now be axisymmetric, their magnetic field can be made significantly higher than in 1980s designs, and their volume much smaller. This design allows using simple tandem mirror plugs, without resorting to more sophisticated concepts such as thermal barriers. The MHD stabilization schemes (many have of which been proposed, some having even undergone preliminary tests) would have to be tested at a small-scale facility (similar to the existing GDT).

4.7.7 Development Path for Neutron-Source, Hybrid, and Pure-Fusion Devices

Development of axisymmetric mirrors for the aforementioned applications can be achieved at a relatively low cost because of the engineering simplicity of axisymmetric mirrors. These facilities are remarkably flexible: adding or removing axisymmetric coils to test new configurations can be done without changing the overall structure of the device. As an example, a small-volume ambipolar plug was installed and successfully tested at the GDT facility. In the past, construction of more-complex facilities, such as

TMX, took about 1.5 years after the decision to build them. The GDT facility at Novosibirsk was built in about 1 year.

One of the paths to construction of the neutron source could be as follows: building a pulsed (20 ms) hydrogen model and demonstrating that absolute (not scaled!) values of the plasma parameter are achievable (3 years); developing steady-state technology (common to all MFE systems) and building a source (5 years); the source will be first operated with hydrogen and will later be switched to a D-T mode. The times here are counted from the decision point.

Performance tests of the mirror as a driver for the actinide burner can be carried out at the same facility as that built to reach design values of parameters for the neutron source. This work can be done through small modifications of the geometry and reconfiguring the beam injectors, in parallel or after the neutron source-related experiments.

Stabilization techniques required for a pure-fusion reactor can be tested in an experiment of the scale of the present GDT device.

Summary statement

These considerations make a strong case for including mirror systems in the new blend of fusion experiments in the coming decade.

References (the LLNL axisymmetric mirror proposal)

1. A.A. Ivanov, A.V. Anikeev, P.A. Bagryansky et al., Paper EX/P5-43, IAEA Fusion Energy Conference, Geneva, Switzerland, Oct. 13-18, 2008.
2. T.C. Simonen, S.L. Allen, T.A. Casper, et. al., PRL, **50**, 1668 (1983).
3. D.D. Ryutov. Fusion Sci. Technol., **47**, 148-154, (2005).
4. U. Fischer, A. Moslang, A.A. Ivanov. Fus. Technol., **35**, T160 (1999).
5. For tandem mirror blankets for hybrids, <http://www.geocities.com/rmoir2003/fusFisHyb.htm> and for direct conversion for mirrors, http://www.askmar.com/Direct_Energy.html

4.8 The Pulsed High-Density FRC as a Neutron Source for Fusion-Fission Hybrid Applications (John Slough,^{*,+} David Kirtley,⁺ Chris Pihl,⁺ George Votroubek,⁺ and Philip Wallace[#] [^{*}U. Washington, ⁺MSNW LLC, [#]Helion Energy])

The pulsed high-density field-reversed configuration (FRC) is intended to operate with a Q of about 1 and with fusion power of about 20 MW. The fissile fuel component will supply the energy gain. The cost of the fusion source is modest, and its small scale and geometric simplicity better match the high power density of the fission reactor and easily coexist with the FFH breeding blanket. The pulsed FRC plasmoid fusion has the attribute of providing such a fusion neutron source while maintaining critical formation, heating, and divertor systems physically far from high neutron fluence and blanket energetics. This key feature significantly moderates many of the difficult design issues associated with an FFH system.

The fusion engine (FE) makes use of a unique magnetic configuration, the FRC, to confine the fusion plasma. The use of the FRC plasmoid also provides for a simple and direct way to heat the plasma as it is transported into the reactor burn chamber (see Figures 8 and 9). Of all fusion plasma embodiments, the FRC alone has the simple linear geometry, high plasma-to-magnetic-energy ratio, and closed field confinement required for a low-cost reactor. Experiments with this configuration have been conducted in several countries and in laboratories in the United States, culminating in the large S experiments (LSX) that demonstrated the scaling required for fusion at higher energy

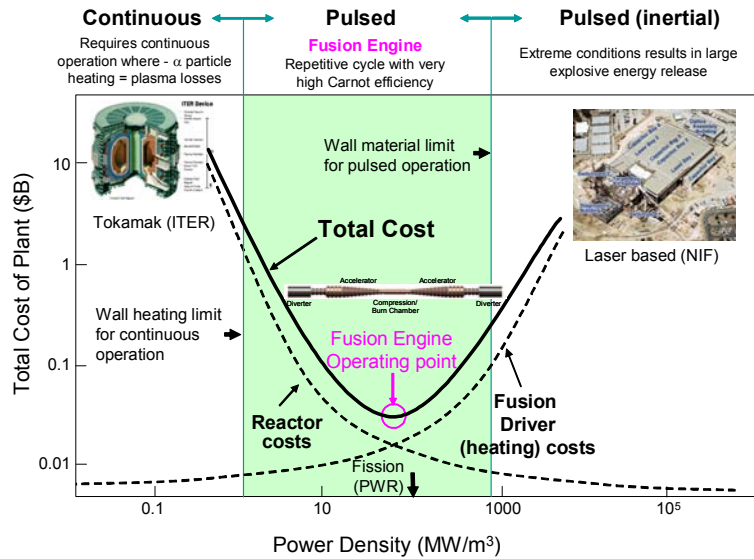

Figure 8. Current and planned break-even fusion prototypes.

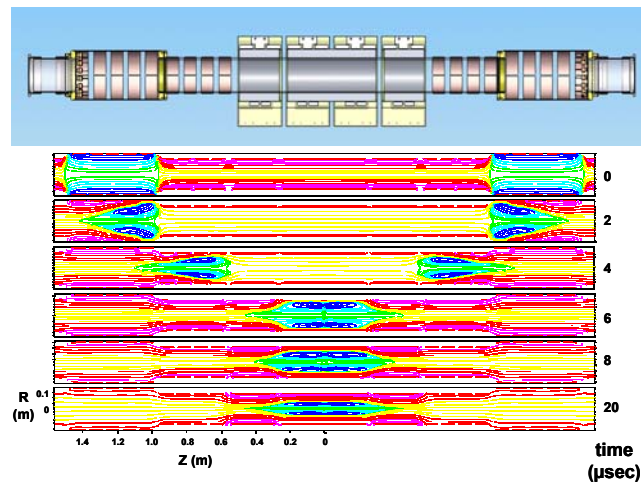

Figure 9. Top: CAD drawing of the magnetic coils employed on the IPA experiment. Bottom: Two-dimensional magnetohydrodynamic calculations reproducing the formation, acceleration, and merging of the FRC plasmoids observed in the experiments.

density. With the observed confinement scaling from past experiments, the energy gain from fusion at optimum plasma temperature with the FRC has the following simple parametric scaling:

$$Q_E = \frac{\text{Fusion energy produced}}{\text{Energy in plasma}} = 0.6 \phi_p B^2 \quad (1)$$

where ϕ_p is the FRC plasma flux and B is the confining axial magnetic field. Previously it was possible to produce an FRC in a small device at high field and low flux, or an FRC at high flux and low field in a large device, but it was clear from the scaling expressed in Equation (1) that the FRC fusion reactor will require both high field and high flux.

Recently a method capable of producing such an FRC was devised — one that has the additional benefit of providing it in a manner that considerably simplifies implementation in a reactor setting. The proof-of-principle experiments for the FE process were successfully demonstrated by employing a device specifically designed for this task, the inductive plasma accelerator (IPA). IPA was developed with funding under Small Business Innovation Research (SBIR) grants from the DOE. The device consists of two magnetically driven accelerators, each of which produces an FRC plasmoid and accelerates it to high velocity with respect to the other (600–800 km/sec). The energy required to heat the plasma to fusion temperatures is stored in this way in the motional energy of the plasmoids. This directed kinetic energy is rapidly converted into thermal energy when the two FRCs merge, as illustrated by the calculations shown in Figure 9. In the initial experiments the FRC plasmoids were observed to merge, forming a single, stable, and hot (500 eV) plasma. Building on this result, a magnetic compression coil was added to increase the plasmoid energy in a manner that will be employed to bring the FRC plasmoid ultimately to fusion gain conditions. In the most recent set of experiments, initiated in 2008, the merged FRC was successfully compressed to greater than 1 keV temperatures at a density of $3.5 \times 10^{21} \text{ m}^{-3}$. In these experiments the FRC plasma confinement time was 50% better than predicted based on past scaling predictions, and the D-D fusion neutron yield was much greater than the thermal expectation.

The next step for the FE concept is a prototype capable of achieving near break-even conditions: the fusion engine prototype (FEP). The projected cost for the low-duty-cycle FEP is less than \$15 M, with a device capable of repetitive operation at 10 Hz (20 MW fusion) requiring a \$40 M investment.

The FEP operating point is reached by the desire to maintain the FRC in the kinetic regime characterized by both tilt stability and reduced transport (i.e., $\phi_p < 75 \text{ mWb}$). From Equation (1), an FRC having $\phi_p = 20 \text{ mWb}$ and the FEP operating with a pulsed compression field $B = 10 \text{ T}$ will yield a $Q_E \sim 1$ sufficient for FFH applications. While FRCs at high flux ($\phi_p \sim 15 \text{ mWb}$) and high magnetic fields ($B = 10 \text{ T}$) have been produced before, the FEP would be the first to do both simultaneously. A schematic of the FEP is shown in Figure 10. The same methodology that was used on IPA will be

employed in energy storage and transfer so that there is no technological or scientific barrier that would prohibit the development of the FEP.

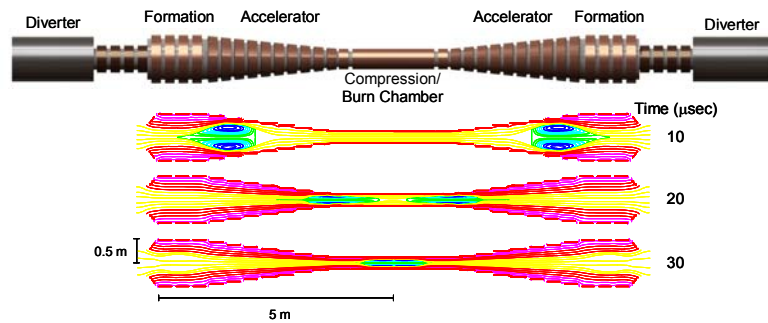

Figure 10. Shown at top is a CAD rendering of the fusion engine prototype designed for a compression field and scale sufficient to produce $Q_E \sim 1$. Below are flux contours from MHD calculation at various times in the formation, acceleration, and compression to fusion conditions.

Advantages of the FE for FFH Applications

The FE has a long list of advantages that reduce development cost and technological challenges. The more significant would include the following:

1. The unique ability of the FRC plasmoid to be translated over distances of several meters, allowing for the FRC formation and kinetic energy input to be added incrementally outside of the burn chamber and breeding blanket.
2. The plasma exhaust (divertor) region can also be well removed from the reactor, eliminating critical power-loading issues. The entire high field reactor vacuum flux is external to FRC plasmoid flux and is thus essentially divertor flux. In a transient burn, the particle loss from the FRC will be overwhelmingly directed to the divertor regions, because the axial flow time is many orders of magnitude smaller than the perpendicular particle diffusion time across the open flux region.
3. By virtue of the cyclic nature of the burn, all of the D-T fuel can be introduced during the initial formation of the FRC plasmoid, eliminating the need for refueling.
4. The ability to locate the divertor remotely in an essentially neutron-free environment makes tasks such as full tritium recovery and divertor maintenance much easier to perform.
5. Both fission reactor gain and divertor wall loading can be easily regulated by the pulse duty cycle.
6. Because of the FE's linear, cylindrical reactor geometry, the breeding blanket coverage is optimized for the FE (see Figure 11). It is critical that a sufficient number of energetic neutrons interact with lithium in the blanket to breed new tritium fuel. With a high conversion efficiency of the fast fusion neutrons in the blanket surrounding the device, the FE can make significantly more fusion neutrons available for fissile fuel generation and waste burning. In order to

rapidly spawn other FEs to handle the waste and fuel requirements of existing fission power plants and to burn accumulated waste, maintaining a low tritium inventory and the ability to create more tritium than consumed will be essential.

7. The simply connected linear geometry of the reactor vessel is amenable to rapid and frequent first wall replacement if necessary. A liquid wall interface is also feasible and allows for operation at the highest power density, as well as resolving several plasma–material wall issues.

With the repetitive and efficient generation of FRC plasmoids, brought to high temperature and density as they are injected into the burn chamber, a compact, low-cost fusion neutron source can be achieved that is ideal for hybrid applications from fuel breeding to waste burning.

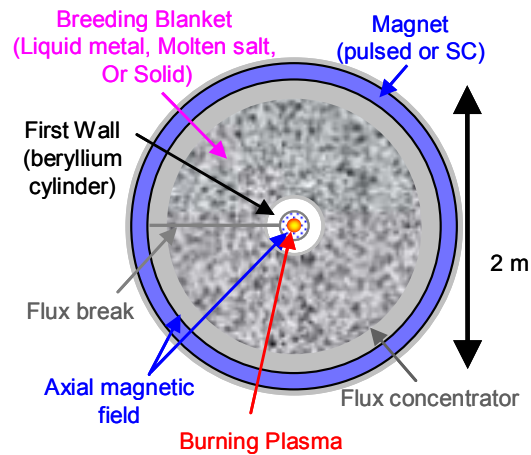

Figure 11. Midplane cross-section of FE with fissile-fussile breeding blanket.

4.9 Potential Applications of a Laser-Based Fusion Test Facility for Fusion-Fission (Steve Obenschain and John Sethian, U.S. Naval Research Laboratory)

In this paper we describe an approach to inertial fusion that is under development for pure fusion applications that might also be attractive for fusion-fission. The viewpoint reflects that of the laser fusion program at the U.S. Naval Research Laboratory (NRL) but makes use of the research of many organizations. The simplest approach to laser fusion is via direct drive. Simulations indicate that this approach can provide more than sufficient energy gain to be used as an energy source. The multi-institutional High Average Power Laser (HAPL) program has had as its goal the development of the laser and auxiliary technologies needed to build a power plant based on laser direct drive.^{1,2} Two laser technologies show promise for this application: diode-pumped solid-state lasers (DPSSLs) being developed at Lawrence Livermore National Laboratory and elsewhere, and the electron-beam-pumped krypton-fluoride (KrF) laser being developed at the NRL.

Both technologies have demonstrated long-duration operation at the required repetition rates and should scale to the energies and efficiencies needed for a fusion power plant.

Herein we describe a particular development path based on the KrF laser. The deep UV ($\lambda=248$ nm) and other properties of KrF are beneficial toward attaining high gains with direct drive targets. Gains above $100\times$ at 500 kJ and greater than $200\times$ at 1 MJ laser energy are predicted by simulations with recent designs. As a point of comparison, these energies are smaller than the energy expected from the National Ignition Facility (up to 1.8 MJ at $\lambda=351$ nm). NRL has identified a staged development path to fusion energy based on this approach. The program is centered around development of a Fusion Test Facility (FTF), which would test all of the components and procedures needed in a full-size power plant.³

Stage 1: Develop Full-Scale Components

- Develop and test full-scale laser module (e.g., 16 kJ, 5 Hz, KrF beamline)
- Confirm and refine high-gain target physics at higher energies
- Develop needed technologies for chamber, optics, low cost target fabrication and engagement
- Design the Fusion Test Facility

Stage 2: Fusion Test Facility (6 years to build, operating by ~2023)

- Demonstrates all the functions of laser fusion power plant
- Made as small as possible to reduce cost and time
- Provides detailed technical and operational basis for power plants

Stage 3: Pilot Power Plants (operation in early 2030s)

- Fusion-powered electricity connected to the grid

This plan leverages the physics base in the National Nuclear Security Administration's initial confinement fusion program and the technologies developed by the HAPL program. A KrF-based Fusion Test Facility might have the following parameters:

KrF-Based Fusion Test Facility

Laser energy	500 kJ
Laser beamline module	16 kJ
Repetition rate	5 Hz
Laser average power	2.5 MW
Laser efficiency	6–7%
Pellet gain	100–140 \times
Fusion power	~250 MW
Chamber inner radius	~4–5M

While the primary function of the FTF would be to develop and test the technologies, materials, and components needed for future power plants, it would have performance approaching that needed to generate power, and might be used to demonstrate net power

production via pure fusion. The reaction chamber inner wall would be at a conservatively large distance from the fusion implosions to ensure its longevity. Test components could be positioned at closer distances to endure high fluxes of neutrons, charged particles, and x-rays from the fusion pellet.

The application of this approach to pure fusion energy is documented in recent journal publications. Here we will briefly discuss how it could be relevant to the application of fusion-fission hybrids. For any laser inertial fusion application to fusion-fission one would need to develop the laser driver and resolve the issues of chamber wall longevity, low-cost target fabrication, and target injection. The FTF research would be applicable. The FTF would be a high-flux fusion neutron source that could be useful for demonstrating the transmutations envisioned for a fusion-fission hybrid. There should not be much difference in the immediate development paths between a goal of pure fusion and fusion-fission with this approach.

The pure fusion follow-on to the FTF would involve constructing prototype power plants with driver energy about 2 to 4 times that of the FTF. The higher energy would produce the needed gain as well as the power needed for GW-class electrical power generation. For the hybrid application, the FTF's demonstrated fusion power could be adequate. The follow-on development path would involve optimizations needed for the fusion-fission application. The very attractive feature for the FTF is that it provides a potentially faster track to both pure fusion and fusion-fission. The final preferred path would be determined by environmental, technological, and economic issues as they evolve with the research.

References (the NRL Fusion Test Facility proposal)

1. J.D. Sethian et al, "The science and technologies for fusion energy with lasers and direct drive targets," Proceedings, 23rd Symposium on Fusion Engineering. Submitted for publication IEEE Transactions on Plasma Science
2. <http://aries.ucsd.edu/HAPL/>
3. S. P. Obenshain, J.D. Sethian and A. J. Schmitt, "A laser based Fusion Test Facility," *Fusion Science and Technology*, **56**, 594-603, August 2009.

4.10 Z-Pinch Hybrid Concept for Minor Actinide Burning (B.B. Cipiti, T.A. Mehlhorn, G.E. Rochau, Sandia National Laboratories)

Z-pinch fusion is a variation of inertial confinement that uses x-rays to heat and compress a fusion target. The Z-Machine at Sandia National Laboratories formed the basis for a hybrid reactor concept that was examined for burning actinides. The conceptual design study examined the net effectiveness for waste reduction, engineering challenges, role in the fuel cycle, and economic drivers.

The Z-Machine dumps an intense amount of energy through a tungsten wire array that surrounds a D-T fusion target. Power delivery occurs on the order of nanoseconds to generate an x-ray source that heats the fuel to initiate fusion. Like other inertial confinement concepts, a high repetition rate would be required to use the neutron yield for actinide burning. The Z-pinch transmutation concept assumes a D-T fusion target

yield of 200 MJ fired once every 10 seconds to power a fission blanket capable of transmuting 1,320 kg of actinides per year while producing 3,000 MW_{th}.

The fission blanket in the conceptual design consists of an annular array of 5 cm pipes containing a molten salt fuel, (LiF)_{0.85}(AnF₃)_{0.15}. The annular array and actinide composition is designed to maintain subcriticality. The molten salt would be recycled continuously for fission product separation, fuel replenishment, and tritium removal. The design uses a lead coolant surrounding the actinide channels to remove the heat and drive the power plant. A first wall separates the lead coolant from the fusion chamber. This study focused on the key engineering issues for developing a more viable reactor design.

Power delivery requires a solid transmission line to the target (an aspect unique to Z-pinch fusion). The bottom portion will be destroyed after each shot, so extensive work has been done to examine a recyclable transmission line (RTL). A low-melting-point metal like tin can be fabricated into the shape of the transmission line using sheet metal forming. After firing, the RTL remains are cut off, and the remnants melt in the high temperature environment to simplify collection and recycling. This driver design will then require a manufacturing capability to produce fusion targets and RTLs every 10 seconds.

A suitable design was developed to minimize neutron damage to the first wall. The first wall and actinide tubes will receive a neutron dose of less than 50 displacements per atom (dpa) after 40 full-power years. This low dpa is accomplished by setting a 2 meter standoff radius from the fusion target to the first wall and leaving a 10 cm gap of lead coolant between the first wall and the actinide blanket. Other fusion designs should be able to follow these same principles to maintain an acceptable dose.

A unique aerosol protection scheme was designed to protect the first wall from x-ray damage. The use of aerosols is possible in the Z-pinch chamber because the device does not need clean chamber conditions (as compared to laser-driven fusion). About 23.5 kg of tin in an aerosol form per shot is adequate for absorbing the x-rays from the fusion target to prevent damage to the first wall. The aerosol volume fraction is $\alpha = 5.93 \times 10^{-5}$.

The temperature increase in the actinide blanket after each shot was recognized as an engineering challenge. The initial design resulted in a 150°C temperature increase per pulse in the molten salt, which is too high for safe operation. The steady-state temperature of the molten salt was also beyond the boiling point of the molten salt, but the project concluded before these issues could be addressed in more detail. Changes to the blanket design, such as spreading out the blanket or “diluting” the actinide content, can address these issues at the expense of reactor size.

Criticality control was also examined and is a challenge with the liquid fuel design. The actinide content and lithium enrichment can be used for long-term control, but control rods would also be needed for rapid response. Solid blanket designs are likely to be safer and easier to license, but even solid subcritical assemblies will need some type of control mechanism in place.

The net effectiveness for transmutation was studied extensively and evaluated by comparing the heat load of the actinides to the heat load of the fission products. A dramatic long-term reduction in heat load by 3 orders of magnitude in 300 years was found by converting the actinides to fission products. However, it is recognized that the lack of heat load reduction in the short term (10 to 20 years) makes it difficult to make this case for politicians.

The Z-pinch fusion driver has advantages and disadvantages, and the conceptual design study provided insight that may prove useful in the design of any future hybrid, regardless of the choice of driver.

Advantages of Z-pinch:

- The linear transformer driver is compact, inexpensive, and efficient; driver cost is expected to be \$30/J of x-rays delivered.
- The solid transmission line provides stability in shots fired.
- The transmission line comes in from the top, leaving the sides and bottom open and free of equipment.
- The chamber vacuum does not need to be extremely low for Z-pinch to fire, making chamber clearing after each shot manageable.
- A liquid metal spray can be used in the chamber to absorb the shock and mitigate wall damage, which also allows for more compact chamber designs.

Disadvantages of Z-pinch:

- Research is less mature than for other concepts.
- Pulsed operation is not as optimal for power plants (as compared to magnetic confinement) and leads to engineering issues such as temperature transients.
- The requirement of a solid transmission line results in engineering challenges — recyclable transmission lines provide a solution but also lead to complexities.
- RTL and fusion targets require a manufacturing capability on site.

Responses to Committee Questions

1. **Main application:** The Z-pinch transmutation concept was examined for use in either burning all the transuranics from light water reactors or only the Np/Am/Cm to start. The design does not change significantly for either, but the support ratio changes considerably.
2. **Present status:** Z-pinch has been able to achieve about 10^{15} n/shot. Approximately 10^{20} to 10^{21} n/shot would be required for the transmutation application.
3. **Intermediate steps:** An intermediate demo would be required to test containment, a high rep rate, and target and recyclable transmission line production. The next step would be a transmutation demo sized to transmute the actinides from one thermal reactor.
4. **Time scale to demo:** The intermediate demo, if started today, would require 15 years to design, build, and add components over time. It would likely take another 10 years to design and build the transmutation demo by 2035.

5. **Research needs:** The intermediate facility must demonstrate adequate containment, high yield (new designs), an advanced linear transformer driver, and repetitive pulsed operation before a transmutation demo will be feasible.

4.11 Fusion-Fission Hybrids Driven by Heavy-Ion Inertial Fusion (P.A. Seidl, Lawrence Berkeley National Laboratory Berkeley, CA 94720)

There is a national need to resolve fuel cycle issues for increasing the role of nuclear energy. The recent Livermore LIFE initiative that builds upon the National Ignition Facility work is likely to rekindle national interest in developing intense, high-power ion beam accelerators for fusion energy production and for fusion-fission hybrid concepts that combine an ion beam–driven fusion neutron source with a fission blanket.

While serving as a carbon-free energy source, hybrids offer the enormous potential benefit of transmuting the long-lived radioactive byproducts of fission-based nuclear reactors, thus dramatically reducing the nuclear waste problem. Systems with sufficiently efficient neutron sources to achieve deep or complete burn-up would eliminate the need for chemical separation reprocessing and make it possible to limit fuel shipments to non-weapons-usable materials, thus achieving a high level of proliferation resistance. In all inertial fusion energy (IFE) concepts, the driver and the reactor chamber are separate, which leads to savings in cost, improved access, ease of maintenance, and reduced concerns for safety and radiation contamination.

For ion-driven fusion, the choice of accelerator has very significant consequences for the achievable energy gain, burn-up, and overall design and efficacy of an ion-driven hybrid system. This is the right time to take a fresh, comprehensive look at the ion-beam energy options. The advantages of heavy ion fusion (HIF), identified in many past DOE reviews¹, still apply:

- Accelerators with total beam energy greater than 1 MJ have separately exhibited intrinsic efficiencies, pulse repetition rates (>100 Hz), power levels (TW), and durability required for IFE.
- Thick-liquid protected target chambers are designed to have 30-year plant lifetimes. These designs are compatible with indirect-drive target illumination geometries, which will be tested in NIF experiments. Thick-liquid protection² with molten salt having high thermal and radiation stability (LiF-BeF₂, or Flibe), has been a standard aspect of most HIF power plant concepts in the past 20 years.
- Focusing magnets for ion beams avoid most of the direct line-of-sight damage from target debris and neutron and gamma radiation. Thus, only the final focusing magnet coils need to be hardened or shielded from the neutrons (diminished flux due to the thick liquid protection).
- Heavy-ion fusion power plant studies have shown attractive economics and environmental characteristics (only class-C low-level waste)³. Accelerator design efforts have converged on multiple heavy-ion beams accelerated by induction acceleration. After acceleration to the final ion kinetic energy, the beams, which are non-relativistic, are compressed axially to the 4–30 ns duration (few-hundred

TW peak power) required by the target design. Simultaneously, they are focused to a few-millimeter spot on the fusion target.

A research and development effort culminating in a credible, integrated design for an HIF-based hybrid prototype would include these topics:

- Designing fusion targets that are able to give satisfactory yield and gain with lower driver beam energy. Doing so will enable lower-cost drivers than for pure fission. Target designs aimed at pure HIF show total driver beam energy requirements as low as 2 MJ for indirect drive⁴ and 0.5 MJ for direct drive⁵.
- Reactor design, neutronics, and radioactive material handling: One objective is to attempt to preserve the significant advantage of thick-liquid protection of the reactor chamber structural wall.
- Can flowing liquid jets feasibly contain the fissile material? Dissolving the fissile material in the flowing jet of molten salt presents significant material handling challenges. Another way to introduce the fissile material to the flowing jets is to have it contained in TRISO pebbles. This containment mitigates the material handling issues but presents significant hydraulic challenges that must be explored.
- Alternatively, should the liquid jets be thinner, allowing a somewhat moderated (but not thermal) flux of neutrons to reach a fissile blanket behind a solid structural wall? Is this feature advantageous compared to a dry or wetted wall reactor design (no neutronics protection inside the first structural wall)?
- The design of lower-cost-driver accelerators for hybrids may be derived in many ways from existing pure-IFE concepts. However, the choice of final kinetic energy, ion species, ion acceleration schedule, and transverse beam focusing architecture will depend primarily on the target design. Thus, an accelerator research program would include beam physics modeling, smaller-scale experiments, and system studies. The near-term objective this program would be the design of two facilities:
 - A prototype experimental facility, capable of doing hybrid and pure-fusion-relevant fusion target experiments at >100 eV, integrated with all key ion-beam manipulations
 - A demonstration power plant design

References (the LBNL Heavy Ion Inertial Fusion proposal)

1. 1979 Foster Committee; 1983 Jason Report (JSR82-302); 1986 National Academies of Sciences Report; 1990 Fusion Policy Advisory Committee report (Stever Panel); 1993 Fusion Energy Advisory Committee (Davidson Panel); 1996 FESAC report (Sheffield Panel)
2. W.R. Meier, Overview of chamber and target technology R&D for heavy ion fusion, Nucl. Inst. Meth. A, **464**, (2001) 103.
W.R. Meier et al, IFE Chamber Technology – Status and Future Challenges, Fusion Science and Technology, **44**, (2003) 27. <http://www-ferp.ucsd.edu/Najmabadi/paper/A1-072-03-FST-Meier.pdf>
3. S. Yu et al., Fusion Sci. Tech. **44**, 2 (2003) 329.
4. D.A. Callahan-Miller and M. Tabak, Phys. Plasmas **7**, 5 (2000) 2083.
5. B.G. Logan, L. J. Perkins, and J. J. Barnard, Phys. Plasmas **15** (2008) 072701.

4.12 LIFE: Laser Inertial Fusion Energy Systems for Pure Fusion Energy and Fusion-Assisted Sustainable, Once-Through, Closed Nuclear Fuel Cycle Energy Production and Waste Management

(The LIFE Team, Lawrence Livermore National Laboratory, 7000 East Avenue, Livermore, CA 94551)

The National Ignition Facility (NIF), a laser-based inertial confinement fusion (ICF) experiment at the Lawrence Livermore National Laboratory designed to achieve thermonuclear fusion ignition and burn in the laboratory, is complete,¹⁻³ and the campaign designed to demonstrate ignition has begun. Fusion yields of 15 to 25 MJ using laser energies of 1 to 1.4 MJ are expected in 2011. Once the fusion conditions required to ignite a central hot spot and sustain propagating burn into ρR of $\sim 2.5 \text{ g/cm}^2$ have been demonstrated, fusion yields of up to 150 MJ can be demonstrated with the 2.5 to 3 MJ of energy available on NIF. That is, the inertial fusion confinement conditions required for ignition and propagating burn (hot-spot temperature and hot-spot ρR and main fuel temperature and main fuel ρR) and fusion yields of 25 MJ (the yields required for hybrid systems) from indirectly driven fuel masses of approximately 0.25 mg of D-T are the same as that required for fusion yields of 150 MJ (for pure fusion systems) from approximately 1.5 mg of D-T. The main difference is that the laser energy required to assemble the 1.5 mg of D-T to ignition conditions and hence produce a yield of 150 MJ for pure fusion LIFE systems) is about 2.5 MJ, versus about 1.4 MJ for the 25 MJ yield from 0.25 of D-T (required for LIFE hybrid systems). See Figures 12, 13 and 14.

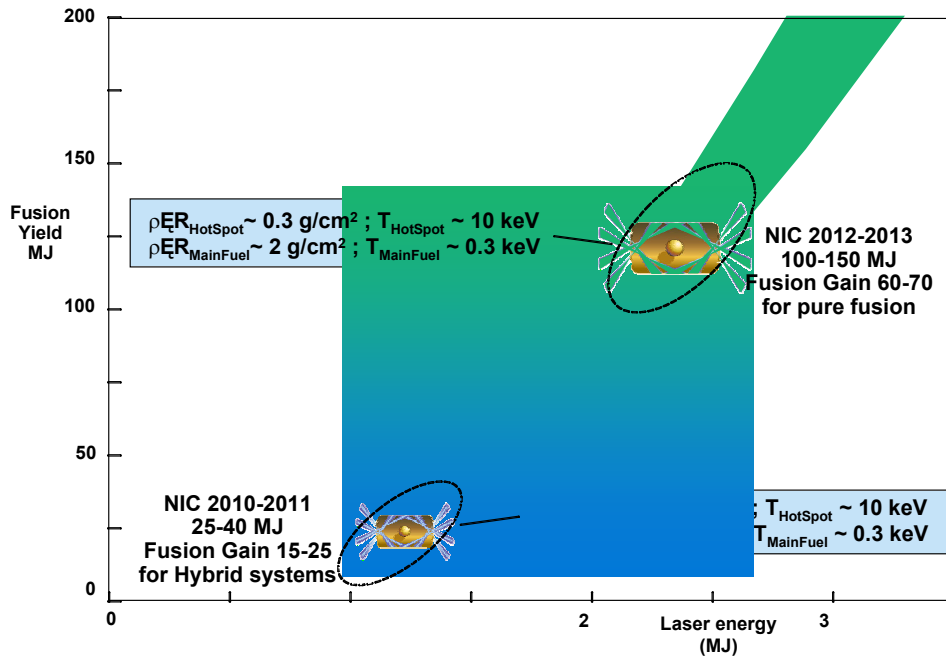

Figure 12. The ignition campaigns on NIF will demonstrate the fusion confinement conditions required for both hybrid and pure fusion systems.

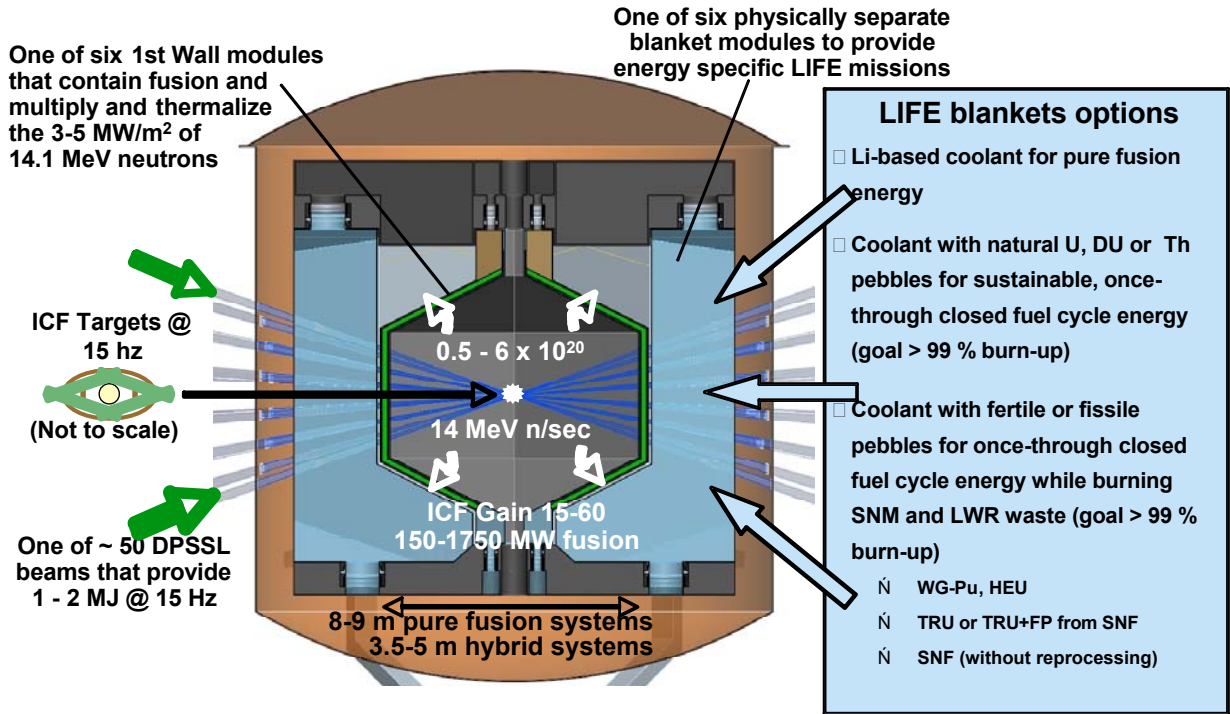

Figure 13. LIFE is designed to function at the first wall conditions and fusion confinement conditions (τR) required for a pure fusion system.

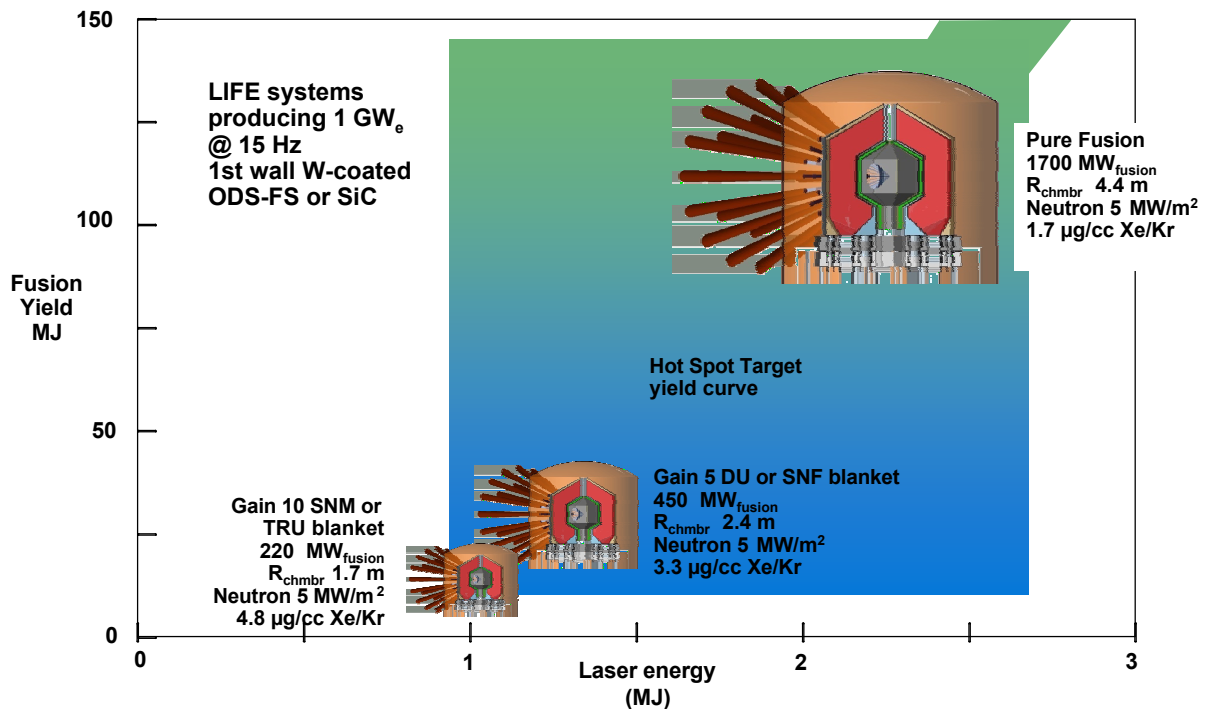

Figure 14. Pure fusion and hybrid LIFE engines have the same first wall design and first neutron and thermal loading. All require a fully functioning fusion engine. The difference is in the driver and fusion MJ, the chamber radius, the chamber gas fill, and the blanket configuration.

The laser inertial fusion energy (LIFE) concepts described in this section are logical extensions of the NIF laser, the National Ignition Campaign on NIF, and ongoing developments in the world nuclear power industry. The LIFE power plant system (see Figure 15) discussed here consists of a 10- to 15-Hz, diode-pumped, solid-state laser (DPSSL) based on and derived from NIF technology;^{4,5} a fusion target factory;⁶ a modular fusion target chamber surrounded by separate modular blanket sections; and the balance of the plant. For both pure fusion and hybrid LIFE systems, the current baseline option for the first wall of the modular fusion chamber is a tungsten coated (~500 μm) oxide dispersion-strengthened ferritic steel (ODS-FS) structure cooled by lithium lead coolant and (in most designs) would contain solid Be for neutron multiplication and moderation of the neutron spectrum. The blanket modules would be either SiC or ODS-FS structures. For a pure fusion system, the blanket modules would contain either lithium–molten salt coolant (such as Flibe), or solid Li in a coolant (the lithium being required to breed T for the fusion targets). In hybrid LIFE systems, the blanket modules would contain fissile or fertile fuel pebbles (described further below) in a lithium-based molten salt (Flibe or Flinak) coolant.

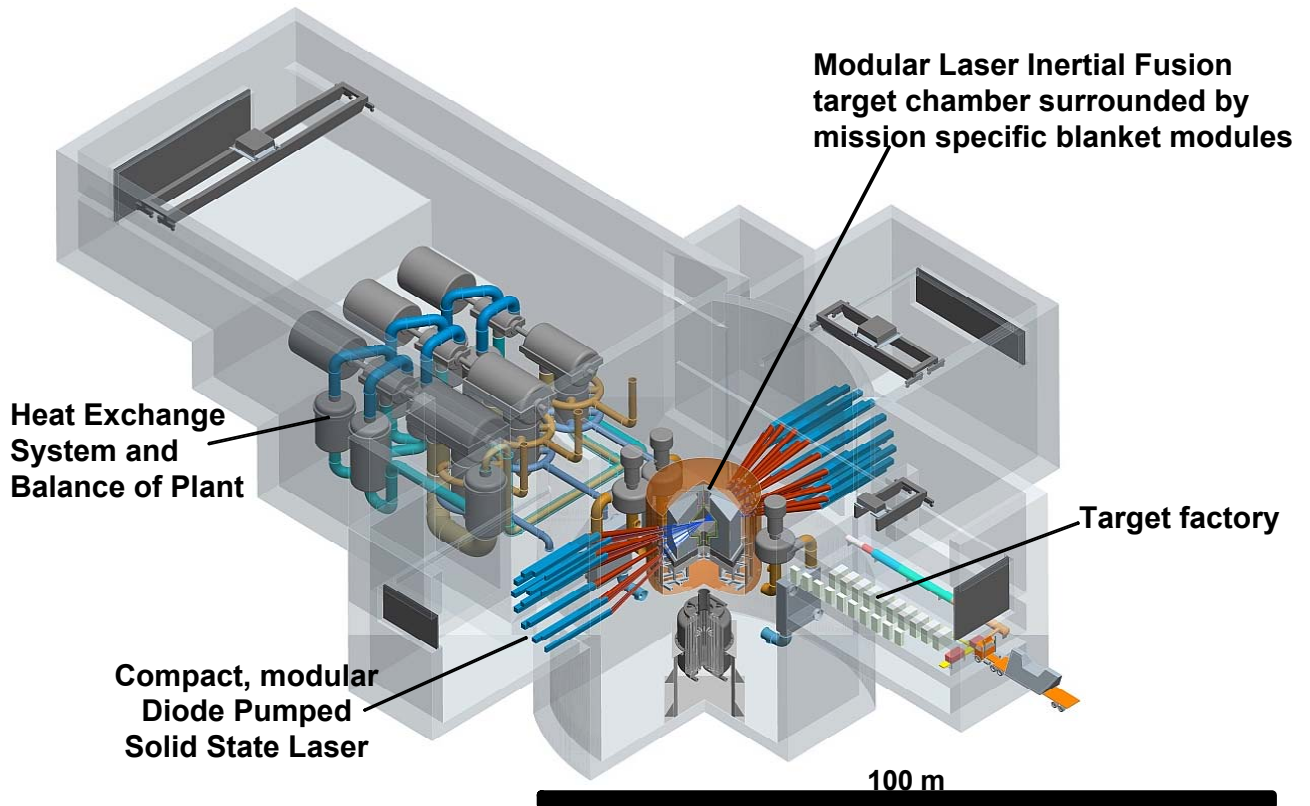

Figure 15. Conceptual design for a LIFE engine and power plant based on the inertial fusion yields from indirectly driven hot-spot ignition targets. The diode-pumped solid-state laser (DPSSL) operates at ~15 Hz, with a wavelength of 350 nm for the 1–1.5 MJ laser energies required for 20–50 MJ yields for hybrid LIFE options, and 530 nm for the 2.5–3 MJ required for the 120–175 MJ yield pure fusion LIFE options. The fusion target chamber, the blanket modules, and the compact modular lasers are shown. The final optics are ~15 meters from the target.

The remainder of this note focuses on various LIFE hybrid systems. For more details, read “A Sustainable Nuclear Fuel Cycle Based on Laser Inertial Fusion Energy,” published in the August 2009 issue of *Fusion Science and Technology*.

The LIFE hybrid systems are designed to operate with fusion energy gains of 15 to 25 and fusion yields of 20 to 50 MJ to provide 200 to 500 MW of fusion power, approximately 80% of which comes in the form of 14.1-MeV neutrons, with the rest of the energy in x-rays and ions. This approach to fusion generates approximately 10^{19} 14.1-MeV neutrons per shot, or approximately 10^{20} n/sec. The high-energy fusion neutrons enter a beryllium region where they are both multiplied and moderated to lower energies. Specifically, approximately 1.8 neutrons are generated for every fusion neutron that enters the multiplier. Outside the multiplier, the neutrons interact with the fission fuel, where an additional energy gain of 4 to 10, depending upon the details of the fission fuel, is realized.⁷ Thus, for hybrid LIFE systems an overall energy gain of 60 to 250 can be achieved. When operated at 10 to 15 Hz, it is possible to generate several gigawatts of thermal power. The thermal power is removed via a molten salt coolant and coupled to a helium or supercritical CO₂ Brayton cycle for high-efficiency electricity production.⁸ A hybrid LIFE engine could have a net electric output of 1000 to 2500 MWe. The power flow and materials flow for a hybrid LIFE engine are shown in Figure 16.

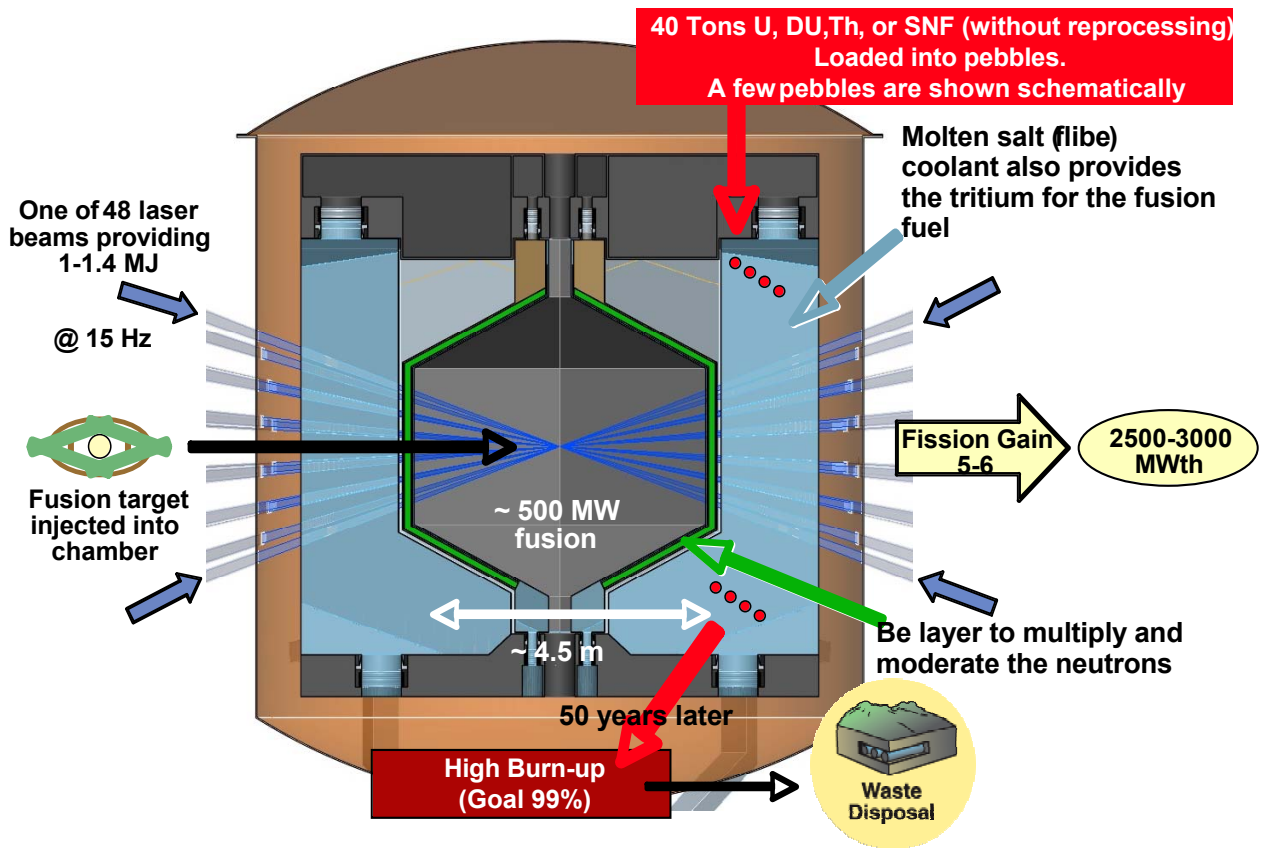

Figure 16. The once-through, closed nuclear fuel cycle hybrid LIFE engine starts with a 15- to 20-MW laser system to produce 375–500 MW of fusion power and uses a subcritical fission blanket to multiply this power to 2000–5000 MW of thermal power.

The molten salt coolant of choice is Flibe — a 2:1 mixture of LiF and BeF₂. Molten salt coolants are attractive because they offer low-pressure operation, and their high heat capacity enables high power densities that can be passively cooled in the event of a loss of forced flow.⁹⁻¹⁰ Flibe is a particularly attractive choice because of the presence of lithium, which produces the fusion fuel tritium. The tritium is collected and used to make future fusion targets.

Since the hybrid LIFE engine uses a deeply subcritical fission blanket ($k_{\text{eff}} < 0.7$ at all times), it is possible to operate with fertile fuels such as depleted or natural uranium, thorium, or even spent nuclear fuel. This feature eliminates the need for isotopic enrichment technologies. Additionally, hybrid LIFE engines would not require chemical separation and reprocessing of nuclear fuels, as has been proposed for breeder-burner nuclear economies. With fuel burn-up of 99% or more, spent-fuel hybrid LIFE engines would contain far fewer actinides than are present in LWR waste. Specifically, a typical loading of fuel for a once-through hybrid LIFE engine (40 metric tons of depleted uranium) would contain less than 1 significant quantity of plutonium at discharge and would thus be uninteresting for nuclear weapons applications. Without isotopic enrichment, chemical separation, and reprocessing or leftover fissile content, a hybrid LIFE engine truly offers the world's first once-through, closed fuel cycle. This fact makes hybrid LIFE systems quite different from previously proposed "hybrid" fusion-fission systems.¹¹⁻¹²

Since the fuel for a hybrid LIFE system begins with a low fissile content (depleted uranium is only ~0.25% fissile and natural uranium only 0.72% fissile), the fission blanket energy gain increases over time. As the fission blanket is driven by fusion neutrons, fissile fuel is produced, and the fission gain increases. Once the desired thermal output is reached, decades of constant power production are provided. Eventually, the fertile material (U-238 or Th-232) is depleted, and the fissile production, and thus the energy multiplication, falls. Figure 17 shows a typical power curve for a depleted uranium-fueled hybrid LIFE engine and the resulting isotopic inventories for several isotopes of interest.

Most of the analyses done so far for the fuel for hybrid LIFE systems has been done with a solid fuel in the form of approximately 2-cm-diameter pebbles containing 1-mm-diameter enhanced tristructural isotropic (TRISO) fuel pellets embedded in a graphite or similar inert matrix (Figure 17), though several alternative high burn-up solid fuels are also being investigated.¹³ In the current design, the fuel pebbles are expected to circulate through the fission blanket at a rate of 0.3 m/day (resulting in an approximately 30-day cycle time per pebble). The pebbles will be taken out for inspection at a rate of approximately 1 to 3 per second and reinserted randomly in the fission blanket to obtain homogeneous burn of the fuel. The very high volumetric heat capacity of liquid salts allows the fission blanket to be compact and have high power density when coupled to a point source of fusion neutrons. In the current design, the Flibe input temperature is

A typical power curve shows a breed-up time of 1-2 years followed by decades of steady power

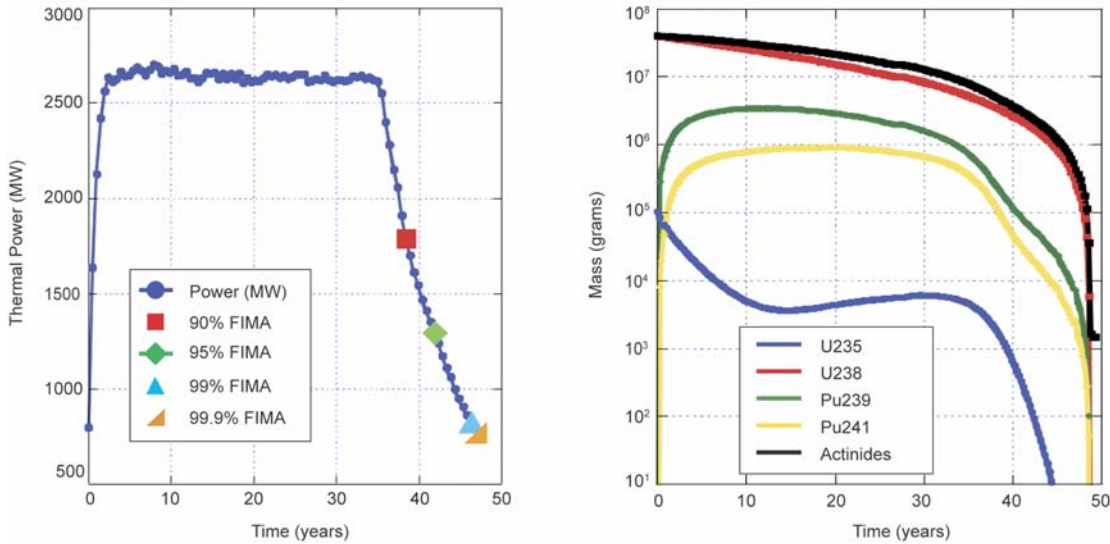

Figure 17. LIFE experiences a time-dependent thermal power output and is able to burn nuclear fuels to levels that result in the disposal of insignificant quantities of plutonium and other actinides. The power and masses as a function of time are for a LIFE engine loaded with 40 MT of depleted uranium. As time progresses, U-238 converts through neutron capture to Pu-239 and higher actinides. When the U-238 is significantly depleted, after approximately 50 years, the fusion neutrons are preferentially used for burning down the actinides that have been bred in the nuclear fuel, and for producing tritium for the fusion targets. At ~46 years (99% fissions per initial metal atom [FIMA]), less than one significant quantity of Pu is present, and other actinides of potential interest for nuclear weapons applications are only present in gram-level quantities, below the Department of Energy’s attractiveness Level E (the lowest level of concern).

610°C, and the exit temperature is 640°C. ODS ferritic steel is thought to be compatible with Flibe at these temperatures, although coating surfaces with the same tungsten coating used for the first wall is another option. Our calculations show that for a hybrid LIFE design with 37.5-MJ fusion and a fusion chamber of 2.5 m diameter, the temperature spike in the TRISO-based fuel pellets that results from the pulse of neutrons entering the fission blanket every 0.1 to 0.075 s is approximately 60°C. Analysis indicates that low thermal stresses of about 10 MPa will be experienced by the SiC layer within the TRISO particles in the front layer of pebbles.

TRISO fuel is being used for the baseline design. Based upon a thorough review of the technical and scientific literature, it is believed that an enhanced version of the Idaho National Laboratory based TRISO (Figure 18) may already be an option for a 5- to 7-year weapons-grade plutonium (WG Pu) or HEU pebble capable of more than 99% burn-up in a LIFE reactor. According to the literature, HEU-fueled TRISO particles have been burned to levels as high as 79% FIMA¹⁴, and more recently, 85% FIMA has been achieved.¹⁵ Thus, 99% burn-up fissile fuels appear within reach. New fuel designs will enable us to overcome the limitations of the current high burn-up fuels for natural or DU TRISO pebbles, limitations that arise primarily because of the inability of the graphite to tolerate the high neutron fluence — 150 to 200 dpa, depending on the specific hybrid LIFE design.

It is believed that a new solid hollow core (SHC) design will help overcome these limitations. Higher mass fraction of fertile material can be achieved with the new SHC fuel shown in Figure 18. The stress in the wall of SHC fuel at fission gas pressures resulting from burn-up as high as 99.9% FIMA has been predicted, and calculated values do not exceed the intrinsic strength of the irradiated materials. This attractive fuel performance is to a large extent a result of the once-through LIFE hybrid fission blanket which operates with a largely thermal neutron spectrum (because of the Be blanket). When fusion neutrons are multiplied and moderated effectively, so that these neutrons enter the fission fuel dominantly at thermal energy levels, then fission events provide the primary source of fast neutrons in the fission blanket, so that fast-neutron damage rates to LIFE hybrid fuel forms are proportional to the fuel discharge burn-up.

The ability to also burn SNF from LWRs would be an attractive feature for hybrid LIFE engines. The OREX process has been used to convert SNF into fuel for Canada deuterium radium (CANDU) reactors, and could be used to manufacture SHC and encapsulated powder fuel (EPF) forms¹⁶.

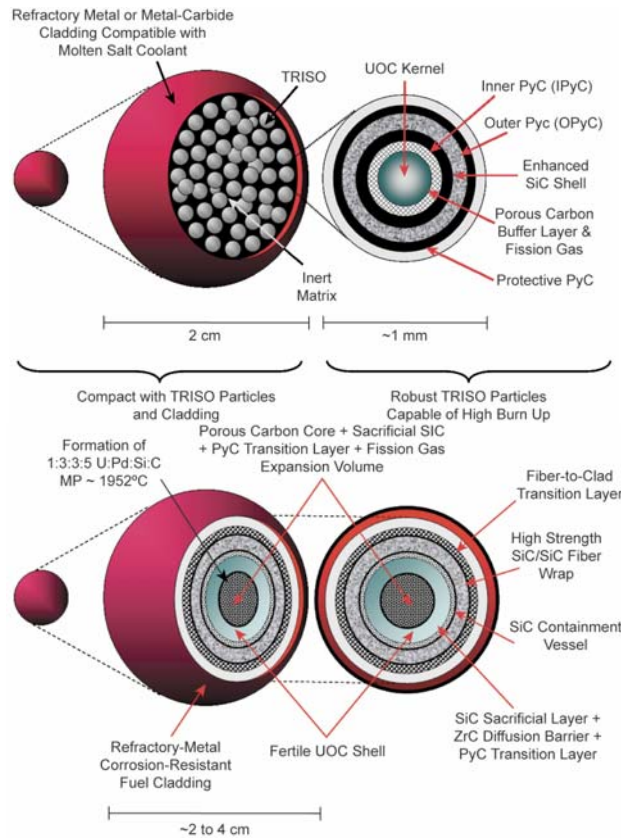

Figure 18. A wide variety of alternative materials and fuel designs are possible and are being evaluated. An enhanced TRISO fuel, with a more robust SiC capsule to enable fission gas containment, is being considered as one possible high burn-up fuel option for LIFE. Higher mass fraction of fertile material can be achieved with new solid hollow core (SHC) fuel.

Unlike solid fuels, molten salts with dissolved uranium, thorium, and plutonium will not be damaged by long-term exposure to neutron bombardment. From a purely technical point of view, such liquid fuels could, therefore, serve as ideal fuels for achieving nearly complete burn-up. Such molten salt fuels have been considered for graphite-moderated molten-salt breeder reactors that operate on the thorium-uranium fuel cycle and enable continuous on-line processing of the fuel. On-line processing is used to keep fission products at desirable levels, and in particular, to remove rare earth elements to avoid precipitation. The use of LiF with UF₄ and ThF₄ is currently being explored for LIFE.¹⁷

Conclusion

The once-through, closed nuclear fuel cycle, fusion-driven hybrid LIFE concept provides a path toward a sustainable energy future based on safe, carbon-free nuclear power with minimal nuclear waste. As such, hybrid LIFE systems provide the current LWR-based nuclear energy industry with an option for expanding now, knowing that a future technology capable of minimizing the long-term nuclear waste and proliferation concerns associated with the current open fuel cycle is well within reach in the first half of this century. The hybrid LIFE design ultimately offers many advantages over current and proposed nuclear energy technologies and could well lead to a true worldwide nuclear energy renaissance.

- Hybrid LIFE systems eliminate the need for costly uranium enrichment and refueling, resulting in sizeable cost savings and significantly mitigating nuclear proliferation concerns. A nation operating hybrid LIFE engines will never have the need to build nuclear enrichment or reprocessing facilities.
- The hybrid LIFE engine extracts virtually 100 percent of the nuclear energy content of its fuel (versus less than 1% of the energy in the ore required to make fuel for a typical LWR).
- Hybrid LIFE drastically minimizes requirements for geologic waste repositories. Hybrid LIFE offers a way to use the SNF now destined for storage in Yucca Mountain and the huge supply of depleted uranium that exists now and will be created in the future.
- In addition to burning natural uranium, a hybrid LIFE engine can use for its fuel the two waste streams associated with the present and future fleet of LWRs — SNF and DU left over from the process used to enrich uranium. If the United States builds a reprocessing facility, as proposed as part of the GNEP, hybrid LIFE engines could also burn as fuel a mixture of plutonium and minor actinides (transuranics) that would be isolated from SNF by reprocessing. Unlike fast nuclear reactor technologies, hybrid LIFE could burn all the high-level waste with a single reprocessing step. Moreover, hybrid LIFE power plants could burn all the high-level waste that exists and that will be created by 2090. Any reprocessing plants built could be decommissioned by this date and would never be needed again.
- When compared with existing and other proposed future nuclear reactor designs, the hybrid LIFE engine exceeds alternatives in the most important measures of proliferation resistance. By integrating fuel generation, energy production, and waste minimization into a single device, the LIFE engine is intrinsically highly proliferation

resistant. It requires no removal of fuel or fissile material generated in the reactor. It leaves no weapons-attractive material at the end of life.

- The hybrid LIFE design is inherently safe. Decay heat removal will be possible via passive mechanisms. In a loss-of-coolant accident, pebbles would be passively dumped into a secondary vessel with favorable geometry for cooling via natural convection.

Fundamentally, the hybrid LIFE engine provides a secure, stable source of non-CO₂-emitting energy that supports national nonproliferation goals. However, despite all the technical and proliferation advantages, it is clear that no nuclear technology is proliferation “proof.” The LIFE team agrees with many national policy makers that, ultimately, active international monitoring will be required at each plant site to ensure that these engines are not operated outside of their obligated agreements and that no nuclear materials are extracted covertly from the core of the engine during operation.

We anticipate that these technical and proliferation advantages will result in cost-competitive operation and generation of electricity and process heat. The advantages of (a) cost avoidance associated with reducing the quantity of uranium ore required, (b) eliminating uranium enrichment and fuel reprocessing, and (c) minimizing requirements for future geological waste repositories coupled with anticipated advances in DPSSL and target technologies, lead to initial projections for capital and operating costs that show that the cost of electricity from the hybrid LIFE engine should be competitive with the projected cost of electricity for advanced nuclear reactor options envisaged for the 2030 time frame.

The issues facing LIFE are largely technological in nature. Well-recognized challenges are associated with pure IFE applications: high-power, high-rep-rate lasers; low-cost fuel capsules; and rapid removal of debris between pulses. A challenge that specifically involves the LIFE hybrid concept is the development of a fuel form capable of existing for a very long period in the blanket without material degradation. Fission experts at the workshop believed that this is a difficult problem that would require a substantial R&D program with no guarantee of success. However, the LIFE program argues that since the LIFE hybrid fission blanket operates with a largely thermal neutron spectrum, fission events provide the primary source of fast neutrons in the blanket. Consequently, fast-neutron damage rates to LIFE hybrid fuel forms are proportional to the fuel discharge burn-up, and computational analyses indicate that a burn-up in excess of 90% should (in principle) be possible.

References (the LIFE team proposal)

This work was performed under the auspices of the U.S. Department Energy by Lawrence Livermore National Laboratory under Contract DE-AC52-07NA27344. UCRL-JRNL-409046.

1. Nuckolls, J. H., Wood, L., Thiessen, A., Zimmerman, G. B., Laser compression of matter to super-high densities: thermonuclear (CTR) applications, *Nature* **239**, 139 (1972).
2. Lindl, J. D., *Inertial Confinement Fusion*, Springer-Verlag 1998.
3. Hunt, J. T., Manes, K. R., Murray, J. R., Renard, P. A., Sawicki, R. W., Trenholme, J. B., Williams, W., Laser Design Basis for the National Ignition Facility, NTIS document No. DE94016700.

4. Krupke, W. F., Prospects For Diode-Laser-Pumped Solid-State Lasers, *Lasers & Optronics*, 79-84 (1988).
5. Caird, J. D. et al., Nd:Glass Laser Design for Laser ICF Fission Energy (LIFE), *Fusion Sci. Technol.*, submitted (2008).
6. Miles, R. et al., "LIFE target fabrication research plan," LLNL report, 2008, LLNL-TR-408722.
7. Kramer, K. J. et al., Neutron transport and nuclear burnup analysis for the laser inertial confinement fusion-fission engine (LIFE), *Fusion Sci. Technol.*, submitted (2008).
8. Zhao, H. and Peterson, P.F., "Optimization of Advanced High-Temperature Brayton Cycles with Multiple-Reheat Stages," *Nucl. Technol.* **158**, 145 (2007).
9. Peterson, P. F. et al., "Fission Safety and Regulatory Analysis for Laser ICF Fission Energy (LIFE), *Fusion Sci. Technol.*, submitted (2008).
10. Abbott, R. P. et al., Thermal and mechanical design aspects of the LIFE engine, *Fusion Sci. Technol.*, submitted (2008).
11. Sakharov, A., *Memoirs*, Vintage Books, New York (1990) 142.
12. Bethe, H. A., The fusion hybrid, *Phys. Today* **32**, 44-51 (1979).
13. Bokros, J. C. et al., Pyrolytic carbon coated particles for nuclear applications, United States Patent 3298921 (1967).
14. D. Petti, P. Martin, M. Phélip and R. Ballinger, "Development of improved models and designs for coated-particle gas reactor fuels," Final Report, International Nuclear Energy Research Initiative, INEEL/EXT-05-02615, Idaho National Engineering and Environmental Laboratory, Idaho Falls, Idaho 83415, December 2004.
15. Private communication, Dr. David Petti INL, Nov 2008.
16. Farmer, J. C., LIFE materials: Overview of fuels and structural materials issues, LLNL-TR-407386 Rev 1, (2008).
17. Moir, R. W. et al., Molten salt fuel version of laser inertial fusion fission energy (LIFE), *Fusion Sci. Technol.*, submitted (2008).

4.13 Driven Subcritical Fission Research Reactor Using a Cylindrical Inertial Electrostatic Confinement Neutron Source (Miley G. H., Thomas R., Takeyama Y., Wu L., Percel I., Momota H., Hora H.,² Li X. Z.³ and P. J. Shrestha,⁴ [¹University of Illinois, Urbana, IL, ¹USA, ²University of New South Wales, Sydney, NSW, Australia, ³Tsinghua University, Beijing, China, ⁴NPL Associates, Inc., Champaign, IL, USA])

4.13.1 Introduction

An accelerator-driven subcritical reactor potentially offers important safety advantages for future fission power systems¹⁻⁵. A fast neutron spectrum subcritical reactor system with heavy metal coolant has received considerable attention in Europe and in the United States and Japan. Alternate versions, using intermediate or thermal spectrum neutronics with lighter moderators, are also possible. Another attractive application of a driven reactor is for burning of plutonium isotopes, actinides, and select long-lived fission products. In addition to large power reactors, special low-power designs are candidates for student subcritical laboratory experiments and research reactors. The driven system is especially beneficial because the enhanced safety allows a wider variety of experimental conditions, including dynamic studies.

The main approach considered for the driver to date has been an accelerator spallation-target system. While this concept appears feasible, the large size and cost of the accelerator system remain an issue. Also, the in-core target system poses significant design and engineering complications. Here we consider the alternative of using unique inertial electrostatic confinement (IEC) neutron sources, which are small enough to fit within fuel element channels or in a central cavity region of the subcritical core assembly. Thus, the IEC replaces both the accelerator system and spallation target by either a central neutron source or by multiple modular sources configured as elements within the “standard” core assembly. This feature provides flexibility in design of the core and in flux profile control. Most importantly, these small units can be produced at a lower cost than the accelerator-target system.

Considerable research on the IEC concept has already been carried out on a laboratory scale⁶⁻¹⁰. However, a key remaining issue concerns the ability to achieve the high neutron rates required using the small volume units that are envisioned. Also, there are engineering issues such as the high-voltage feed-throughs, which will require improved technology to prevent unwanted arcing in the intense radiation fields encountered in the reactor core. Ongoing IEC research aimed at the higher neutron yields required is described here.

4.13.2 Prior Work on the IEC Neutron Source

The basic IEC concept traces back to Philo Farnsworth, the inventor of electronic television. The present IEC neutron source units are a modification of his original design, which developed a unique grid-produced plasma discharge operating in the unique “star” mode¹¹. This configuration is illustrated conceptually in Figure 19. The ion gun added is not used in the “base” gridded star mode design. In addition to the spherical unit, a unique cylindrical version has also been developed at the University of Illinois, and it provides an alternative geometry for subcritical driven application.

In the spherical design, the transparent grid, biased at 60 to 100 kV, acts as a cathode relative to the grounded vacuum vessel wall. When deuterium is used, ions produced in the discharge are extracted from the plasma by the cathode grid, accelerated, and focused at the center of the sphere where nuclear fusion reactions occur. The grid provides recirculation of the ions, increasing the power efficiency. At high currents, an electric potential structure develops in the non-neutral plasma, creating virtual electrodes that greatly enhance ion containment and recirculation^{11,12}. This feature is essential for the good ion confinement required for developing efficient, high-neutron-yield devices. Once formed, the virtual electrodes replace the grids, which can then be removed. Experimental measurements have demonstrated the existence of such potential structures, but at considerably lower currents than those required for higher yields. Structure stability could be an issue at high currents, although theoretical studies have not identified a problem to date.

Present steady-state IEC units produce $\sim 10^8$ D-D n/s, while advanced pulsed versions extend to 10^{10} n/s, equivalent to 10^{12} n/s if D-T is used under similar conditions. As discussed later, this is in the range desired for use in small research reactors, but it is roughly four orders of magnitude lower than what is needed for driven power reactor applications. Still, the present devices have greatly enhanced the understanding of the discharge physics involved and, from a practical viewpoint, offer an attractive low-level neutron source for applications such as a neutron activation analysis (NAA)¹³.

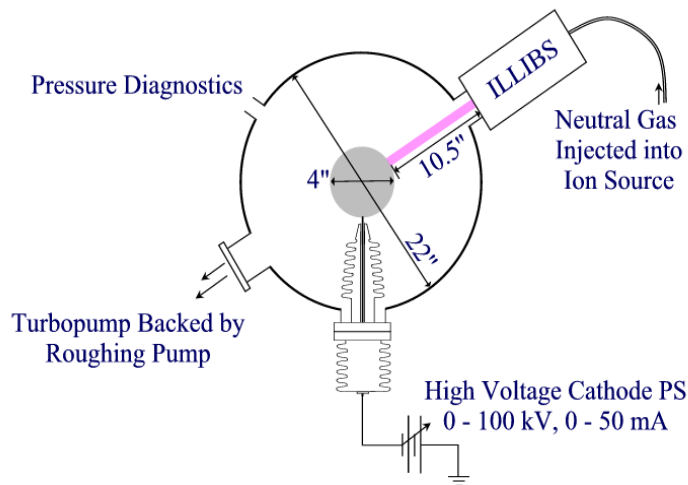

Figure 19. Arrangement of the gridded star mode IEC with the ILLIBS ion source attached.

The concept of using an IEC to drive a subcritical reactor was proposed earlier based on gridded IEC concepts⁶⁻¹⁰. However, grid transparency issues can be avoided by the use of virtual electrode structure formed in a high-current ion-injected spherical IEC or, alternatively, in the hollow electrode cylindrical IEC design^{14,15}. Both approaches are briefly discussed here.

4.13.3 Ion-Injected IEC

- a) Recent IEC research at the University of Illinois at Urbana-Champaign has explored a unique external ion source, ILLIBS (Illinois Ion Beam Source), as a way to ultimately achieve virtual electrode IEC operation. ILLIBS employs an RF-driven plasma in a graded magnetic field configuration (see Figure 19), and can be incorporated into the IEC as shown in Figure 20. This approach allows initiation of the plasma discharge below the normal (Paschen relation) discharge breakdown region, and because of the low chamber pressure losses due to charge exchange are greatly reduced,

improving the neutron production efficiency and allowing higher yields. Wide ranges of sub-breakdown deuterium pressures (0.4 to 2 mTorr) have been studied. With 100 Watt input RF power, ILLIBS provides a high ion-current extraction efficiency and a deuterium ion flux of 6×10^{18} ions/(cm²-sec) at 65 mA with a well-collimated beam diameter of ~3 mm. With the ion gun on, a neutron rate of 2×10^7 n/sec was achieved

with grid voltage and current at 75 kV and 15 mA, respectively, at 1.2 mTorr. These results suggest that using the D-T gas mixture and increasing the ion current in this unit would give a neutron rate of 7.3×10^{12} n/sec at 1.2 mTorr, 75 kV, and 1.5-A ion current. These predicted values would provide neutron levels consistent with low-power research reactor requirements discussed later. Such operation provides a significant improvement in neutron production efficiency, reducing power handling problems associated with high-yield operation. Significantly higher yields could be achieved by further increasing the input power and adding multiple ILLIBS units.

The details of ILLIBS are shown in Figure 20. The antenna is made from about 4 meters length of coaxial insulator high voltage wire, wound around a glass tube containing the fill gas. The RF signal (13.56 MHz) is applied to one end of the antenna while the other end is grounded. The oscillating magnetic field created within the coil is directed along its axis and induces a vortex electric field. Then, the negative potential on the IEC grid serves to extract ions from the RF discharge.

4.13.4 Cylindrical IECs

While most IEC research to date has involved spherical devices, cylindrical IECs offer

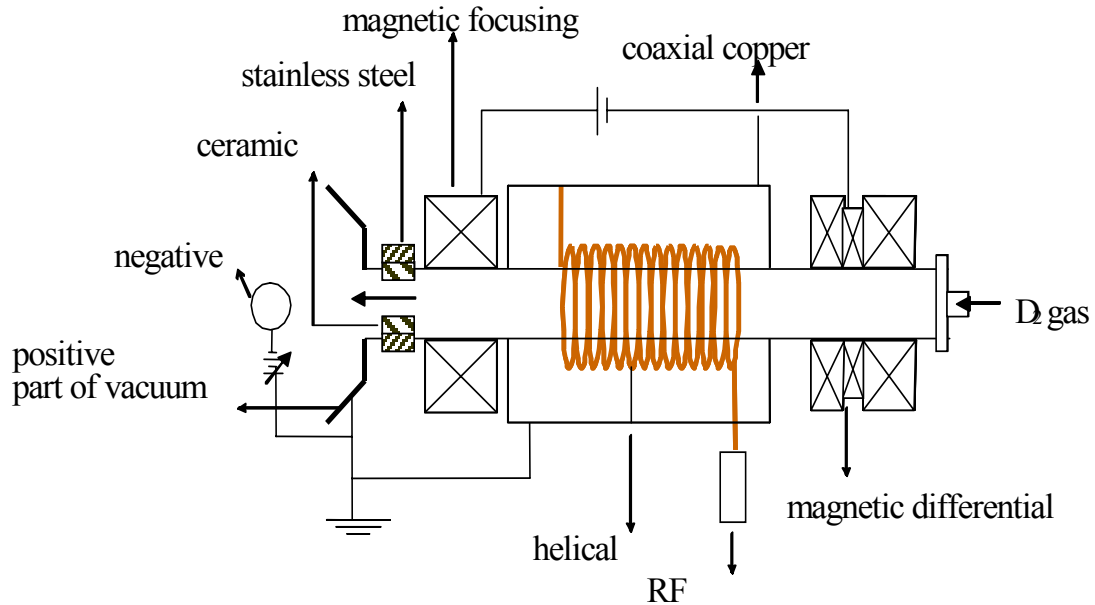

Figure 20. Typical setup of the ILLIBS. The main components are: magnetic-index DC coils, coaxial copper shielding, antenna, front magnetic focus coil, and floating exit nozzle. The three back coils are connected in series.

many advantages in a variety of practical applications, including the present subcritical reactor system^{14,15}. The cylindrical geometry is advantageous in a wide range of engineering configurations that require coverage of a broad area with neutrons. It is also capable of more efficient heat rejection than the gridded spherical unit, since rejected heat is carried by the larger area hollow electrodes rather than thin-line or plates.

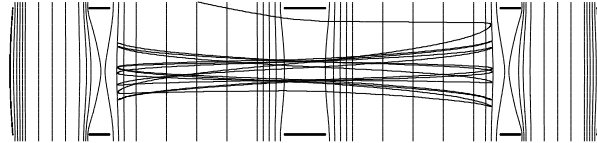

Figure 21. Diagram of the C-device with calculated ion trajectories and equi-potential surfaces.

The prototype cylindrical IEC version (Figure 21), called a C-device, has a geometry that is particularly attractive for the driven subcritical application. It forms deuterium (or deuterium-tritium) beams in a hollow cathode configuration such that fusion occurs along the extended colliding beam volume in the center of the device, giving a line-type neutron source. The prototype design uses hollow cylindrical anodes (held at ground potential) at either end of the unit, while a similar but longer hollow cylindrical cathode in the center of the device is biased to a high negative potential. Deuterium gas introduced at the end of the unit is ionized in the resulting discharge, creating an ion source. These ions are accelerated back and forth along the axis of the unit, where they collide and fuse.

The prototype C-device shown in Figure 21 uses three electrodes placed in a cylindrical glass vacuum chamber having a diameter of approximately 8 cm and length of approximately 100 cm. The center cathode is constructed from a hollow, thin-wall, stainless steel tube. The two anodes are also hollow steel tubes, held at a large positive potential (about +80 kV). Positive ions formed in the plasma between the electrodes are accelerated toward the center cathode. Because the anodes and cathode are hollow, most ions and electrons pass through them without colliding with the structure, giving an effective transparency of nearly 100%.

Figure 22 also shows a calculated ion trajectory plot for the C-device. The tightly focused beams passing through the center cathode are evident from the plot. The electrodes at the ends of the chamber, called “reflector” dishes, are solid, concave steel surfaces held at ground potential. These dishes “reflect” and focus electrons toward the centers of the anodes where they pass through and recirculate in a manner similar to the ions. The ion density peaks in the beam path, significantly enhancing the fusion rate along the interacting beams.

4.13.5 Proposed Initial Use in Low-Power Research Reactors

The first use of IEC-driven systems could well be for application to low-power research reactors. In this case, a lower-source strength is required, and present experimental IEC devices are very close to meeting that goal. This concept is illustrated by some approximate calculations for a representative system.

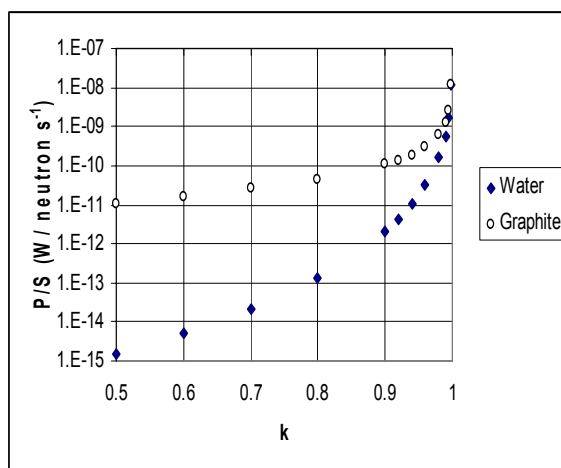

Figure 22. Power level per unit source (P/S) as a function as a function of k_{∞} for two different moderators.

Figure 22 presents the power obtained per unit source as a function of the multiplication factor k_{∞} . The system is assumed to be a cylindrical homogeneous reactor, fueled by uranium dioxide. Results for two different moderators, graphite and water, are presented. The fuel enrichment is adjusted to give the desired value of k_{∞} , maintaining the fraction of core volume occupied by the fuel fixed at 5%. From the figure, it can be observed that the graphite-moderated system can deliver 1 kW of power with a source of 1012 neutrons/sec when the multiplication factor of the reactor is 0.99, far from critical. Specifications for that system are summarized in Table 5.

Fuel	UO ₂ (0.5% U-235)
Moderator material	Graphite
Moderator volume fraction	95%
Multiplication factor	0.99
Radius (cm); Height (cm)	30; 50
Source strength (neutrons/s)	1x10 ¹²
Power (kW)	1.2

Table 5: Parameters for a 1 kW graphite-moderated subcritical system.

In summary, while these calculations are quite approximate, this study provides a target reference design for a 1-kW IEC-driven graphite-moderated research reactor. As

discussed earlier, such a reactor appears to be quite attractive from a cost and safety point of view. Also, since existing experimental IEC devices have already achieved approximately 10^{11} DT n/s equivalent, the improvement required in this technology to achieve the target of 10^{12} n/s to drive the system outlined in Table 5 appears to be feasible in the near term. This is consistent with the source levels used in existing research reactors such as Garching II, where subcritical operation is based on a Cf-252 neutron source with 4×10^9 neutrons/sec.

4.13.6 IEC Configuration for the Subcritical Reactor Design

- b) The IEC driven-reactor system would be designed to ensure safety against criticality and loss-of-coolant accidents, as is done in the conventional accelerator-target designs. Some important differences exist, however, in the method used to safeguard against hypothetical beam power and reactivity increase accidents. In accelerator designs, a passive beam “shut-off” device is incorporated using a combination of thermocouple readings and a melt-rupture disk in the side wall of the beam guide tube¹⁷. The IEC would use a simple temperature-sensitive fuse in the in-core electrical circuit to shut down the high voltage needed to maintain neutron generation. A melt rupture disk on the IEC wall could be added to spoil the IEC vacuum.

To illustrate the IEC system, a rough conceptual design for a 1000 MWe plant has been developed. The reactor core employs distributed IEC units as shown in Figs 23a and 23b.



Figure 23a. Vertical cross-section of the core showing cylindrical IEC modules (dark vertical lines), Figure 23b. Cross-section view of the reactor core showing the IEC modules (cross-hatched channels).

In this design, cylindrical IEC units occupy seven fuel channels and are stacked such that 15 units can be stacked in each channel. Although a variety of arrays are conceivable, this particular configuration was selected to optimize neutron profiles in both the radial and vertical directions across the core. This “distributed source” design is to be contrasted with an accelerator-driven reactor where the center of the core is allocated to the spallation target. In contrast, waste heat from the IEC is deposited on the large-area hollow electrodes and removed through the normal coolant flow around the fuel channels.

The conceptual 1000-MWe reactor is designed with a $k_{\text{eff}} < 0.99$ requiring $\sim 10^{15}$ n/s per IEC module. This source rate is to be compared to the present experimental values of $\sim 10^{11}$ D-T n/s from the pulsed C-device (the D-T “equivalent” yield based on measured D-D rates). While the driven reactor requirement is four orders of magnitude larger, there does not appear to be a fundamental block for such a scale-up in source strength¹⁷⁻¹⁸. Since IEC scaling involves velocity space scattering losses (vs. cross-field diffusion as in other magnetic confinement devices), increasing the yield does not require a significant increase in unit size. Instead, higher beam currents and improved ion recirculation are the key physics issues. Other crucial issues involve technology concerns such as incorporation of other high-voltage stand-offs that are “radiation hardened” against the high nuclear radiation levels encountered in the nuclear core. Fortunately, many of these issues can be studied using a small unit, allowing a low-cost, time-effective R&D program.

4.13.7 Conclusions

An alternative to the standard driven reactor accelerator-spallation target design is proposed employing IEC neutron sources that can be in a central location or distributed across a number of fuel channels. Such a modular design has distinct advantages in reduced driver costs, plus added flexibility in optimizing neutron flux profiles in the core. The basic physics for the IEC has been demonstrated in small-scale laboratory experiments, but a scale-up in source strength is required for ultimate power reactors.

However, the IEC source strength is already near the level required for low-power research reactors or for student subcritical laboratory devices. This application would be advantageous since the safety advantages of these reactors should enable a next generation of research reactors to be constructed quickly, meeting educational and research needs during a rebirth of interest in nuclear power.

References (The University of Illinois Electrostatic Confinement proposal)

1. Dautray, R., “Future Development of Energy Resources”, Position paper CEA, CHC/93-104, 1993.
2. Rubbia, C., “Harmless Energy from Nuclei: A Quest Worth Pursuing?” *Workshop on Innovative Options in the field of Nuclear Fission Energy*, Centre de Physique des Houches, 1998.
3. Carelli, M., Green, L., and Paramonov, D. V., “A Sub-Critical Reactor Design for Accelerator Transmutation of Waste,” *3rd Int’l Topical Meeting on Nuclear Applications of Accelerator Tech.* 1999, pp. 359-366.
4. Beller, D. E., Van Tuyle, G. J., and Venneri, F., “Systems Studies of ATW-Coupled Fuel Cycles for the 21st Century,” *3rd Int’l Topical Meeting on Nuc. Appl. of Accelerator Tech.*, 1999, pp. 355-358.
5. Wider, H. U. Karlsson, J., and Jones, A.V., “Safety Advantages of Heavy Metal-Cooled Accelerator-Driven Systems,” *Joint Research Centre of the European Commission, Inst. for Systems, Informatics and Safety (ISIS)*, 1999.
6. Miley, G.H., Momota, H., Shaban, Y. and Hora, H., “Progresses in Development of a Converging Beam Neutron Source for Driving a Driving a Sub-Critical Fission Reactor,” *ICONE 10*, 2002, pp. 1-7.

7. Miley, G.H., Stubbers, R. A. and Momota, H., "Advances in Cylindrical IEC Neutron Source Design for driven Sub-critical Operations," *ICONE 11*, Tokyo, Japan, April 20-23, 2003.
8. Miley, G.H., Stubbers, R. A., Wu, L. and Momota, H., "An IEC-Driven Sub-Critical Assembly for Teaching Laboratories Offering a New Generation of Sub-Critical Experiments," *14th Pacific Basin Nuclear Conf.*, Mar, 2004.
9. Hora, H., Prelas, M.A., and Miley, G. H., "Kernspaltreaktor mit unterkritischer Auslegung", German Patent 4327920 C2 (priority 23.Aug.1993, granted 13.Mar.2003).
10. Hora, H., and Miley, G.H., "Upgraded reactor for electrostatic confined nuclei," German Patent Appl. 10118 251.1, 2001.
11. Miley, G.H., Gu, Y., DeMora, J.M., Stubbers, R.A., Hochberg, T.A., Nadler, J.H. and Anderi, R.A., "Discharge Characteristics of the Spherical Inertial Electrostatic Confinement (IEC) Device," *IEEE Trans. on Plasma Science*, Volume 25, No. 4, 1997, pp. 733-739.
12. Gu, Y. and Miley, G.H., "Experimental Study of Potential Structure in a Spherical IEC Fusion Device," *IEEE Trans. on Plasma Science*. Feb, 2000, pp.331-346.
13. Kulcinski, G.L., "Overview of Neutron/Proton Source Applications from IEC Fusion Devices," *Trans. of the ANS*, Volume **77**, 1997, pp. 507.
14. Bromley, B., Chacón, L., and Miley, G. H., "Approximate Modeling of Cylindrical IEC Fusion Neutron Generator," *Proc. 16th Int'l Conf. on Numerical Simulation of Plasmas*, 1998, pp. 191-192.
15. Chacón, L., Bromley, B., and Miley, G. H., "Prospects of the Cylindrical IEC Fusion Device as a Neutron Source," *Proc. of the 17th IEEE/NPSS Symp. Fusion Engr., CA, 2, 1997*, pp. 858-861.
16. Lancaster, D.B., Ludewig, H., and Todosow, M., "Technology Options for Accelerator Transmutation of Waste," *3rd Int'l Topical Meeting on Nuc. Appl. of Accelerator Tech.*, 1999, pp. 347-354.
17. Miley, G.H., Bromley, B., Jurczyk, B., Stubbers, R. M., DeMora, J. M., Chacón, L. and Gu, Y., "Scaling of the Inertial Electrostatic Confinement (IEC) for Near-Term Thrusters and Future Fusion Propulsion," *STAF98*, Part 3, 1998, pp. 1373-1375.
18. Chacón, L., Miley, G.H., and Barnes, D.C., "Energy Gain Studies of Spherical IEC Devices Using the BAFP Code," *Bulletin APS*, Volume 44, No. 7, 1999, pp. 48.

Chapter 5

Blanket and Nuclear Technology

N. B. Morley (Chair), M. Abdou, J. Blanchard, J. Gehin, P. Peterson, D. Petti

Various published materials and reports were reviewed and discussed by the panel during a series of conference calls and during two morning sessions at the ReNeW Fusion-Fission Hybrid Workshop. Attention was focused as much as possible on the fission and fusion blanket, materials, fuels, and other nuclear technology issues. Top-level requirements, advantages, questions, and concerns were formulated and are presented in Section 5.1. With input from concept advocates, information on several particular representative hybrid systems was considered in more detail and is described in Section 5.2. Findings and recommendations are summarized in Section 5.3 and are reported in the chapters on findings and research needs, Chapters 9 and 10. Contributions and review by W. Meier, M. Kotschenreuther, W. Stacey, R. Moir, G. Wurden and the other workshop participants are gratefully acknowledged.

5.1 High-Level Observations and Requirements

5.1.1 Hybrid Blanket Requirements

Hybrid blanket systems must perform all the functions required of pure fusion blanket systems, namely, producing and recovering tritium sufficient to continuously refuel the plasma or inertial fusion energy (IFE) targets; capturing and exhausting the fusion power; and shielding other components (such as magnets, vacuum vessel, and mirrors) as necessary to meet their lifetime, waste disposal, or reweldability requirements. In a hybrid, the pure fusion functions are augmented by the desire to use the fusion neutrons to drive an additional fission blanket system that accomplishes some combination of transmuting fission waste, producing power from fissionable fuel, and/or producing additional fissile material for fission reactor fuels.

The combined fusion-fission blanket must typically multiply fusion neutrons via reactions in beryllium, lead, and/or fissionable isotopes; allow neutrons to reach and drive the fission fuel with additional neutron and energy multiplication; and minimize parasitic capture and leakage of neutrons such that tritium self-sufficiency can still be achieved via reactions of unused neutrons with lithium. Depending on the type of hybrid considered (transuranic transmuter, power producer, fuel producer) and the nature of the fusion driver (tokamak, ST, mirror, inertial fusion, and so on) the fusion-fission blankets can take different forms and adopt different strategies for meeting their respective mission, cost, and availability targets. Other aspects of fusion nuclear technology, such as the need for viable divertors, plasma heating and current drive systems, mirrors, and target injection and tracking systems, must still be accomplished together and by sharing space with the fusion-fission blanket systems.

Developing hybrids will require substantially the same types of research and development needed for pure fusion and for new fission fuels and fission-fusion safety.

But depending on the particular hybrid concept, goal, and design, hybrids may make it possible to ease difficult requirements on the materials and components to some degree. Clearly, the addition of fission requirements results in new complications and hardware systems that will affect overall plant availability, and whose integration must be demonstrated. Similar development steps and integrated testing like what is needed for pure fusion energy technology will be necessary for hybrid technology development as well. The easing of some performance requirements may help reduce development risk or allow for fewer development iterations during technology development when compared to pure fusion, but integration and reliability remain dominant concerns that could determine the overall development time.

5.1.2 Potential Benefits of Hybrids from the Blanket Perspective

Various strategies and goals for hybrids have been proposed, but from the perspective of the blanket and nuclear technology, the most likely benefit stems from the possibility of reduced load (both in neutrons and surface heating) per unit of useful energy generated on the first wall, divertor, and plasma control structures that comes from lower power plasma operation or yield due to significant energy multiplication behind the first wall in the blanket. There may be an economic and availability benefit from this reduced load if the first wall does not need to be replaced as often or if the overall size of the system is made smaller, but this benefit will should be considered in the context of any additional shutdowns needed to remove or shift the fission fuel. There could be R&D cost and development time benefits if materials requirements, in terms of both displacements and helium generation, could be reduced in favor of more near-term materials while still meeting economic performance goals. Additionally, if the energy deposited in the first wall, divertor, and other plasma-facing components becomes expendable (a small percentage of overall system power), it may be possible with some acceptable economic penalty to design and operate hybrids with coolants and temperature regimes most beneficial to their reliability rather than power conversion performance. It should be noted that reducing wall load or the material lifetime damage is not a goal in all hybrid concepts; examples are discussed in Section 5.2.

Significant neutron multiplication is also possible for hybrid concepts using fissionable or fissile materials that produce several neutrons per fission in the blanket. While the full neutron economy must be carefully evaluated, there is potential for significant multiplication of neutrons and improved tritium breeding. There has been some discussion about whether the addition of fertile and fissile material in the blanket would reduce the average neutron mean free path via additional absorption in the fast and epithermal energy regimes. Such an occurrence would imply a potential to reduce neutron leakage from the blanket and to design more compact blankets with more uniform and higher average power density. A more detailed study of the various concepts is needed to assess this potential accurately.

Hybrid blanket reliability could also improve if fusion drivers could be selected or operated such that disruptions are eliminated or at least substantially reduced. Tokamaks that are run with lower field, lower plasma current, lower plasma kinetic energy, and

operated away from known stability limits may allow for reduced a number and/or intensity of disruptions, easing requirements on the blanket and divertor structures. Also, the reduced fusion power requirements for the hybrid driver may make it possible to select drivers (such as mirrors; see Reference 12) that have the potential for a simpler geometry and easier maintenance or replacement than that of toroidal magnetic systems. This driver selection may help improve the overall maintainability of a hybrid application compared to that of pure fusion.

In all of the hybrids, the fission blanket runs subcritically, which proponents claim is a large advantage over fission systems. Subcritical operation can enable the use of a wider range of fission blanket designs than is possible for critical systems, which must be designed to remain critical during prolonged burn-up, to have negative power reactivity feedback, and to have sufficient reactivity safety margin against prompt criticality. But pure fission systems, such as modular helium reactors, can be designed to have intrinsically high negative temperature feedback, allowing reactivity shutdown following loss of heat sink, even without reactor scram (anticipated transient without scram, or ATWS events). Conversely, for hybrids and for some fission reactor designs, highly reliable reactivity control systems are required to assure shutdown of the neutron source or insertion of shutdown elements following loss of heat sink, to prevent fuel damage. The degree to which subcritical operation offers a distinct advantage must be analyzed for each specific system.

In many hybrid concepts, the fusion power itself can be varied and used as a control element to keep the blanket power constant over long burn-up periods. This variability is an additional capability of a driven system, but unintended plasma overpower events are certainly plausible and must be carefully analyzed and well understood.

There may also be fuel cycle benefits related to increased burn-up of fission fuels and transmutation of more difficult-to-manage fission fuels when compared to critical fission systems; however, these aspects were not studied in detail by the blanket panel and conclusions are deferred to the fuel cycle panel.

The development process for hybrid blankets could be easier than for pure fusion blankets, depending upon the degree to which the hybrid designs might relax blanket technical requirements on the one hand (discussed above), and the degree of added complexity and new required systems and functions on the other hand. Some of these concerns are discussed below. Certainly, testing components at a quasi-steady-state of 1 MW/m^2 , as envisioned for a component test facility for pure fusion, can produce higher confidence for hybrid blankets intended to operate near this flux level, compared to pure fusion blankets intended to operate at $\sim 3 \text{ MW/m}^2$. But in quantifying this higher confidence one should not simply claim that ITER technology (materials and components) can be used, as ITER is cooled with low-temperature water, uses materials that do not extrapolate to typical fusion reactor application with high fluence (like copper and stainless steel), and overall has a low availability and a need for frequent component replacement. Fusion reactor-relevant blanket systems, even at low fluence and neutron

wall load, have not yet been built or tested, although testing in ITER itself is planned by other several ITER Parties as part of the ITER Test Blanket Module program.

5.1.3 Concerns Regarding Hybrid Blanket Systems

Fission blankets that have been proposed for use in a fusion-fission hybrid are notional analogs of the fuel systems used in fission reactor cores and thus share much of the same technology and associated issues. These blankets can contain fissionable materials for neutron multiplication and power generation, fertile fuels for fissile material generation (such as Th or U), and transuranics and/or minor actinides for destruction via transmutation. The fuel forms under consideration range from metal and/or oxide fuels for fast neutron spectrum blankets, inert matrix fuel forms and/or ceramic particle/pebble fuels for thermal blankets, and mobile fuel dissolved in molten salts or liquid metals.

Solid Fuel Issues

The fabrication routes for these fissile fuels, a key viability criterion, have not been completely identified. Adapting the fabrication processes for pin/clad type fuel forms used in the simple hexagonal or square geometries of cylindrical fission reactor cores to the complex toroidal and poloidal geometries in magnetic fusion or the angular and azimuthal geometries in inertial fusion will be very difficult. The use of particle fuels in pebbles will overcome some of these geometry issues. However, depending upon the level of burn-up, the particle fuels being discussed for the hybrid may not be the traditional tristructural isotropic (TRISO) fuel used in high temperature gas reactors; rather, they may include different coating layers whose fabrication is today unknown. In particular, thorium fuel driven to 40 to 60% burn-up may be within the capability of conventional TRISO fuel, while uranium fuel driven to more than 90% burn-up would require an extensive (and not necessarily successful) development effort.

Normal Operation Issues

While the fission blanket in the hybrid may look neutronically very similar to that in a fission reactor, the fusion environment offers additional challenges. For example, the limited space and access inside the vacuum vessel raises serious concerns about the ability to shuffle fuel rapidly or deploy control rods (and burnable poisons) to shape the neutron flux to ensure that the fuel operates within its allowable window. The impact on the fuel of magnetic fields ($J \times B$ forces) in the MFE configuration, especially during disruptions, and the high cycle fatigue associated with the high rep rate of inertial system is not yet known. The pin/clad fuel traditionally has tight limits on power peaking to limit potential failure mechanisms in the fuel. This peaking is a concern given the large variability in local power density in all three dimensions of the fusion blankets in the complex fusion geometries under consideration. The use of lithium-6 as a burnable poison and the use of moveable fuel (such as pebbles and dissolved fuels) in the fission blanket inside the fusion vacuum boundary have, at first glance, some advantages in regard to accommodating the difficult geometry, smoothing out variations in heat generation in the blankets, and allowing operation with constant fusion power input.

For blankets placed outside the fusion vacuum boundary (an ex-vessel blanket), the axial and radial power distribution must be carefully evaluated because of the neutron penetration problem through the fusion blanket and around the magnets. An inhomogeneous distribution could lead to hot spots and flow control issues (hot channels and cooler channels) that are much greater than in a fast reactor. In addition, with this ex-vessel blanket the vessel that holds the transuranic fuel will experience more significant neutron damage than fission reactor vessels, which are always robust and see low fluence (similar to the vacuum vessels in magnetic fusion). Demonstrating the robustness of such a vessel to regulators is necessary given the hazards associated with leaks of sodium and complete loss of coolant accidents (LOCAs) in fast reactor systems.

Space requirements for this concept must also be very carefully considered. It is clear in current plasma confinement devices or in the ITER design that there are cooling pipes, pumps, heat exchangers, dump tanks, cryostats, beam/heating systems, pellet inject systems, vacuum pumping systems, and so on that need room around the fusion core. Especially for a spherical torus (ST), there is significant doubt that only limited off-midplane access for all these systems will provide sufficient space. The systems will likely have to compete for space within the fission blanket, complicating its design.

It appears likely that maintenance will take longer in most of the hybrid concepts reviewed, relative to pure fusion blankets, because of the extra requirements caused by the presence of the fission part in the blanket. Some concepts attack the issues of maintenance and fuel shuffling by removing the blanket to the outside of the fusion driver or by decoupling as much as possible the fission and fusion blanket functions. A more complete systems analysis will be needed to evaluate the degree to which these approaches are successful.

Safety Issues

The hazards associated with the fusion-fission hybrid are higher than for pure fusion because of the large inventories of transuranics, minor actinides, and fission products produced in the fission blanket in addition to the tritium and activation products in the fusion system. The very large inventory of short-lived fission products in a hybrid blanket makes decay heat removal a critical safety issue, except in the fission-suppressed design concepts (see Section 5.2.4). Loss of heat sink in these high-power-density fission blankets is very critical (analogous to ATWS in pure fission systems) and can lead to overheating of the fission blanket in a short time (on the order of tens of seconds according to the specific analysis in Reference 23, summarized in Chapter 4 for the subcritical advanced burner reactor, SABR). Fast-acting detection and shutdown systems will be required to ensure plasma shutdown upon loss of heat sink in the fission blanket. It will be more challenging to achieve passive safety in these fusion-fission blankets for LOCAs than in their fission analogs because the more complex geometry makes emergency core cooling system (ECCS) design more difficult. In general, fixed-fuel hybrids may require active ECCS systems with forced circulation cooling, while movable fuel designs (pebbles or liquid fuels) may rely on fuel dump systems to tanks that provide passive decay heat removal following LOCA.

Hybrids use extensive neutron multiplication to drive the subcritical fission blanket. To keep power levels constant, the fusion power, neutron multiplication, lithium-6 loading, and/or other reactivity control (such as control rods) must change over the cycle to compensate for burn-up. Online refueling could mitigate, but not eliminate, this power variation issue. The variable fusion power of the fusion driver also raises some safety concerns. An inadvertently high fusion power on a fresh fusion blanket can lead to significant overpower events, possibly leading to failure and melting of the fission fuel. Systems to prevent such an occurrence may be difficult to implement, as has been the case for the fast-fusion shutdown system in ITER, given the stringent reliability requirements associated with detection and actuation.

Beyond conventional off-normal events to be considered in pure fission systems (loss of flow, loss of coolant, reactivity related events), the impact of the unique fusion energy sources (magnetic energy, plasma energy) on the fission blanket will need to be evaluated. The hundreds of megajoules to gigajoules of energy associated with the magnetic fields are certainly a concern for any arc potential that could cause significant damage to a fission blanket. The impact of a plasma disruption or other plasma anomalies on the structural response of the fission blanket and fuel will also need to be considered carefully and will certainly be design specific (size, plasma current, coolant, etc.) and fission fuel specific (oxide fuel, metal fuel, etc.). The fission blanket will need to be tested in as prototypic an environment as possible to understand and characterize the degree of coupling between the fusion and fission blankets, the potential for interactions between these two systems (in both normal and off-normal events), and the safety margin in the design. Initial sample and unit cell testing could conceivably be performed in a pure fission system, with added fissile material providing the source of neutrons needed to drive the hybrid blanket. But subsequent integral testing of the coupled fusion-fission system will be required. This testing could be quite costly and time consuming (especially considering that containment will likely be necessary), and must be considered in the development plans for any hybrid system.

Technology Readiness and Qualification Issues

These concerns make clear that the technology readiness for the blankets in the fusion-fission hybrid is behind that of their pure fission analogs, and the capability needed to test hybrids under prototypic conditions is currently nonexistent. According to fission experts on the panel, qualification of a new fission reactor fuel is typically a more than 20-year endeavor, given the time it takes to establish viable fabrication routes for these fuels, the time required to build up the performance data base on the fuel under irradiation and accident conditions, and the need to modify the fabrication and/or design as performance information is generated about the fuel. This benchmark is based on the history of fission reactor fuels development at a time when there was a large infrastructure to support fission reactor technology. Given the much more limited infrastructure in place today (such as test reactors and hot cells) and the need to test some of these blanket concepts in a fusion environment, qualification may take even longer.

5.2 Description of Representative Hybrid Concepts

In this section, several recent hybrid proposals representative of different blanket and nuclear technology strategies are examined in more detail. Descriptions of other hybrid concepts, as well as additional information on the concepts described below are also available in Chapter 4 of this report and in the provided references.

5.2.1 The Fusion-Fission Blanket in Inertial Fusion

The laser inertial fusion engine (LIFE) is a fusion-fission hybrid based on an inertial confinement fusion driver¹⁷. Several different missions are being considered for the LIFE hybrid, including power production using natural or depleted uranium, burn-up of spent nuclear fuel, and burning of excess weapons material. The concept receiving the most analysis to date is a power-producing hybrid with an initial fuel load of depleted uranium (DU).

The blanket strategy is to first multiply neutrons in a Pb-Li-cooled Be region and then do energy multiplication and waste burning in a movable TRISO-like solid fuel cooled by a molten salt mixture of lithium and beryllium fluorides (Flibe). The LIFE goal is to develop a fission fuel form that can survive to 99% fission of initial metal atoms (FIMA). Others have argued that thorium-based fuels could still provide significant benefits, even at lower discharge burn-up levels of 40% to 60% in the range achievable with current high-temperature reactor fuels. TRISO-like fuels in graphite-matrix fuel pebbles and new designs, such as the solid hollow-core pebble that has features to accommodate the build-up of fission product gases, are being considered to achieve the higher burn-up levels.

Some tritium is bred in the Pb-Li first-wall coolant, but the majority comes from the Flibe blanket coolant. The Li-6 content of the Flibe is adjusted over time to keep the system thermal power constant over the burn period. Excess tritium is produced and stored during the majority of the burn period and is then used at the end of the burn cycle to maintain constant power for as long as possible while the fissile content is depleted. This strategy will require storage of many kilograms of tritium.

A radial build and key parameters are listed for a typical design in Tables 1 and 2. The fusion power is 500 MW (typically 50 MJ at 10 Hz). At steady power, which is reached within 1 year, the overall power multiplication is 5.35, giving a thermal power of nearly 2700 MWt. With the 650°C Flibe coolant outlet temperature, the multiple-reheat Brayton power conversion cycle has a conversion efficiency of ~46%, producing 1200 MWe gross or nearly 1000 MWe after accounting for laser and in-plant auxiliary power consumption. The high outlet temperature requires use of an oxide-dispersion strengthened (ODS) type ferritic steel as the structural material.

In the recent version of the chamber, shown in Figure 1, the first wall is not physically coupled to the fissile blanket. In this concept, the blanket structure will not require replacement as frequently as the first wall, which is designed for rapid replacement. For

example, the chamber wall is not the vacuum barrier. The chamber sits in a steel-lined concrete vault that is the vacuum boundary. Therefore, the beam tubes do not connect directly to the chamber, a feature that will aid replacement. Both pure fusion and hybrid IFE chambers must be designed to enable chamber clearing. In general, because hybrid systems will use lower-yield targets and have smaller chambers, the clearing is anticipated to be somewhat more rapid.

There are many aspects of the hybrid blanket that require significant R&D, and many of these are shared with pure fusion blanket R&D needs, such as high-rep-rate chamber clearing and target injection and tracking; radiation damage-resistant structural materials capable of high-temperature operation; liquid metal and molten salt compatibility with materials, pipes, heat exchangers, and pumps; tritium extraction, control, and processing technology, and so on. A particularly challenging R&D need is the development of the fission fuel form that can meet the objective of 99% FIMA in order to avoid the need for reprocessing and to reduce the final inventory of high-level waste per unit of power produced. While the goal is to design the fuel to accommodate very high burn-up in the fuel, the significant fusion power and small chamber size lead to significant damage and helium production in the first structural materials. The first wall will require replacement every 4 years, even assuming a lifetime of 200 dpa, which is commonly used as a goal for fusion materials development. Since the fusion wall load is high, helium production near the first wall is just as severe as in pure fusion. In this case, there is no easing of the materials development requirements relative to pure fusion, although economics may be improved because of the reduction in first wall replacement costs per unit of useful energy generated.

Zone	Nominal thickness, cm
First-wall armor (W)	0.5
First wall (FS)	2.5
FW/multiplier coolant inlet plenum (PbLi)	3
Perforated wall (FS)	0.5
Multiplier (Be pebbles/PbLi)	15
Perforated wall (FS)	0.5
FW/Multiplier coolant extraction plenum (PbLi)	3
Multiplier/blanket separation walls	0.5 each
Blanket coolant inlet plenum (Flibe)	5
Fission blanket (fuel pebbles, moderator pebbles, Flibe)	100
Perforated wall (FS)	0.5
Outlet plenum (Flibe)	5
Outer wall (FS)	1

Table 1. Chamber radial build.

Fusion power, MW	500
Power multiplication (including decay heat)	5.35
Thermal power, MWt	2675
First-wall radius, m	2.42
Fusion neutron wall load, MW/m ²	4.75
Be zone power density, MW/m ³	15 (avg)
Fuel zone power density, MW/m ³	15 (avg), ~100 (peak)
First-wall coolant, °C in/out	260/450
Blanket coolant, °C in/out	620/650

Table 2. Key parameters of a typical LIFE design.

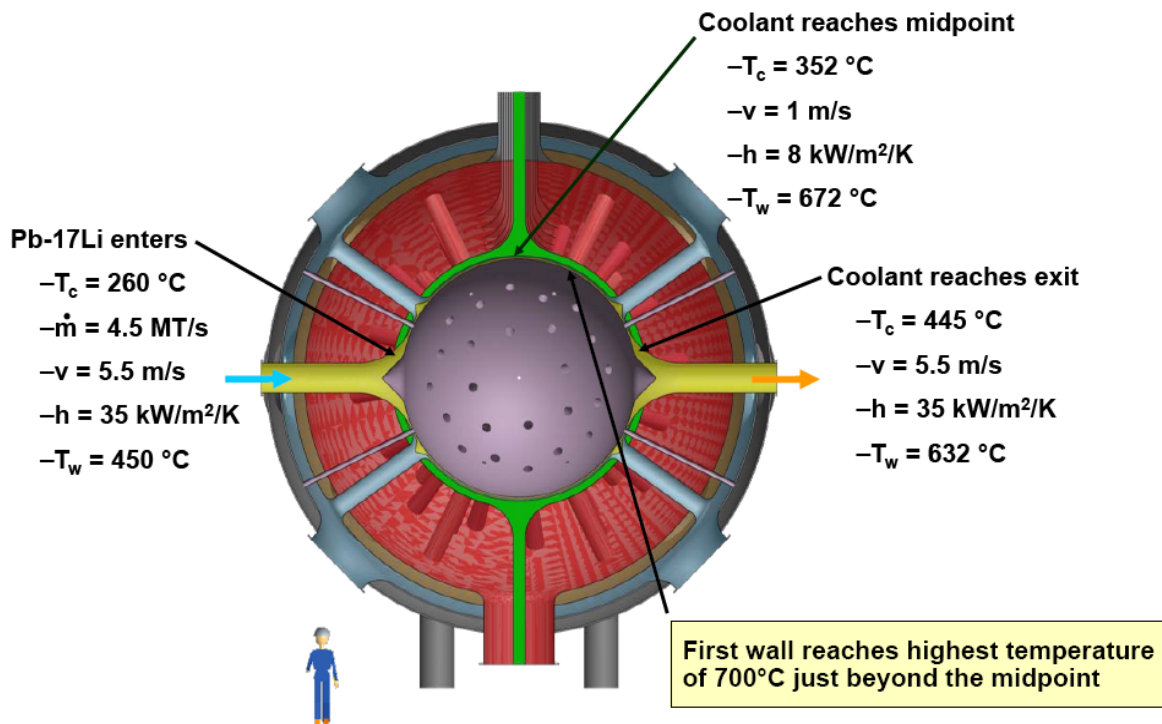

Figure 1. Cross-section through the proposed LIFE fusion-fission hybrid chamber.

With regard to safety, the pebbles are “drained” to a dump tank with a natural convection coolant circuit in the event of a severe accident, such as a loss-of-coolant event.

5.2.2 Combined Fusion/Fission Blanket Inside a Magnetic Fusion Vacuum Vessel

The subcritical advanced burner reactor (SABR^{20,23}) proposed by Georgia Institute of Technology is one example of a system design with the blanket region located within the fusion vacuum vessel and the toroidal field magnets. Locating the blanket in such a manner provides a close interface with the plasma neutron source, which is separated only by the plasma first wall. However, being located within the vacuum vessel may result in more difficulty in refueling processes and larger impacts of the magnetic fields on the blanket fuel and coolant. The SABR design is largely based on a combination of

ITER scale with some support technology for the fusion source where possible and sodium-cooled fast-reactor (SFR) technologies with improved cladding for the fission blanket. The vacuum vessel and the toroidal field magnets are shielded such that they last the 30-year life of the plant.

The overall system configuration is shown in Figure 2, which consists of the D-T fusion source (based on the ITER), the plasma first wall, the fission blanket, and the tritium breeding blanket and shield within the vacuum vessel. The fission power for this system is 3000 MW with a maximum k_{eff} of 0.95, requiring a 42 MW fusion power for fresh fuel and 370 MW for highly burned fuel. Analysis has been performed on the design of the system in order to compute the overall transmutation performance, fission power, fusion source requirements, coolant requirements, component lifetime, and tritium breeding.

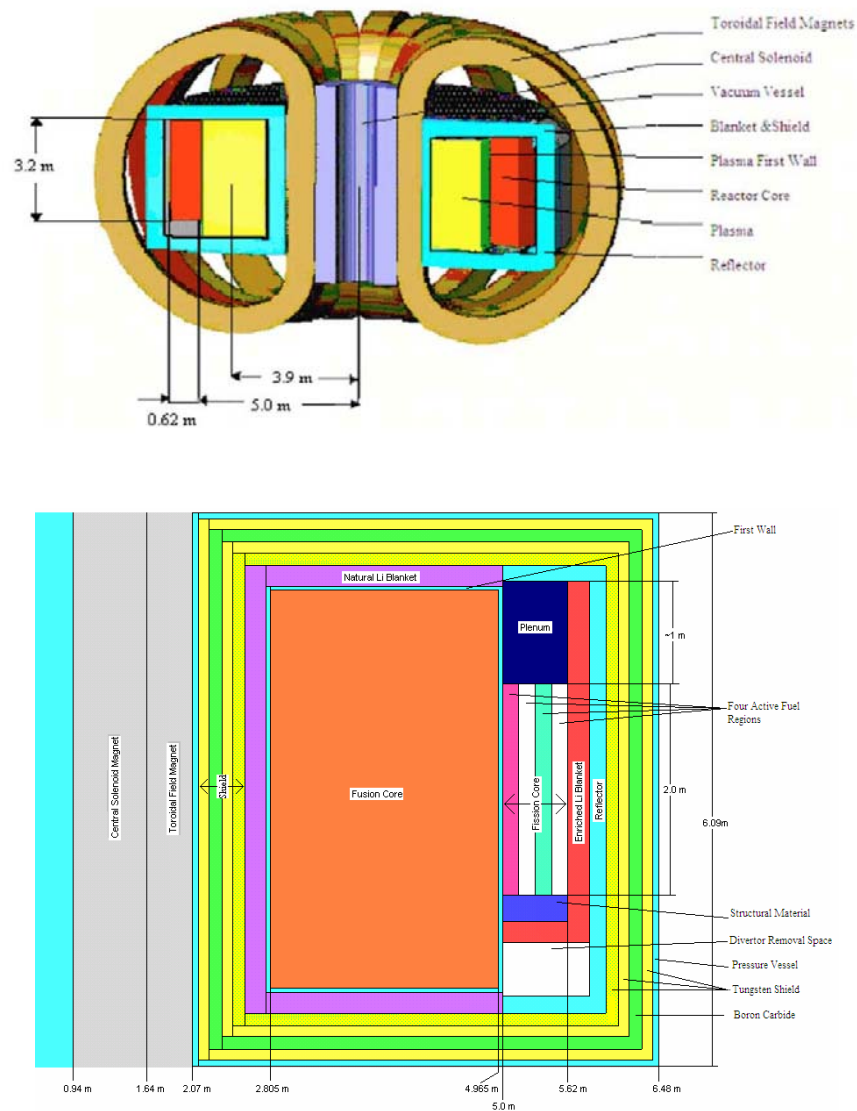

Figure 2. Configuration of SABR in tokamak and blanket cross-section.

The first wall is a beryllium-coated ODS steel structure using a sodium coolant (although gas-cooled reactor versions have also been analyzed). The maximum heat flux at full power is approximately 0.25 MW/m^2 , but the structures are designed for heat fluxes of $0.5\text{--}1.0 \text{ MW/m}^2$. At the full design power of 500 MW, the first wall will require replacement every 6 effective full-power years based on an anticipated damage limit of 200 dpa. However, the fusion source will operate at a variable power level to maintain a constant fission power level, with a lower overall power level potentially allowing for first-wall replacement less frequently, or accommodating reduced ODS steel damage limits. The divertor, based on the ITER divertor with W blocks and CuCrZr tube, will also be cooled by sodium and will require more frequent replacement than the FW, approximately every four years, corresponding to two fuel shuffling cycles. Because ODS steel with a high irradiation damage limit is identified as the main structural material and fuel clad, concerns similar to those listed for LIFE regarding the early stage of development of this material must be repeated here. The use of copper alloys in the divertor must also be carefully considered and the divertor's lifetime evaluated given its expected embrittlement at low neutron dose.

The steady heat loads are estimated from ITER and some analysis regarding the heat removal capability is reported. However, magnetohydrodynamic (MHD) effects are not considered in the sodium coolant analysis and will be a dominant concern. The use of an LiNbO insulator coating to reduce MHD pressure drop effects is described, but the viability of such coatings is not considered likely in the current fusion R&D program for strongly non-isothermal fusion reactors in strong irradiation environments. Even in the event of a perfect insulation, flow distribution between complicated flow paths, with many turns, manifolds, complicated fuel geometry, and so forth, will still be dominated by MHD concerns, and significant R&D will be required to establish the design and feasibility of such a system.

The fuel contained in the fission blanket consists of a metal fuel (40Zr-10Am-10Np-40Pu) that is similar to that being proposed for sodium-cooled fast reactor (SFR) recycle programs. The fuel is clad in ODS ferritic steel to provide a long core residence time. A liquid sodium coolant is used, which circulates through an intermediate heat exchanger, similar to SFR. The blanket has four annular rings of hexagonal fuel bundles with 217 fuel pins. The blanket fuel will be shuffled from the outer rings to the inner rings during operation every 750 days and will be removed after shuffling operations for a total residence time of 3000 days (8.2 years). This shuffling appears to require the removal of the blanket from the vacuum vessel, which will be a time-consuming endeavor.

The tritium breeding blanket is located outside the fission blanket (see Figure 2) and on the inboard side and top of the plasma chamber. It is designed such that the system is tritium self sufficient based on a tritium breeding ratio of 1.16. The breeding material is lithium silicate and will be designed to have channels for the sodium coolant to remove the 56 MW of power produced in the blanket. The breeding blanket represents the first layer of shielding to protect the superconducting magnet insulators, which are located

outside the vacuum vessel. In addition, there are layers of tungsten and boron carbide to provide further shielding.

The technology for the blanket system is based primarily on SFR technology and therefore has similar reactivity coefficient behavior, with a slightly negative Doppler reactivity coefficient and a fuel expansion coefficient, a positive sodium void reactivity coefficient and a fuel rod bowing reactivity coefficient. Analysis was performed for an uncontrolled loss of flow accident (LOFA) based on a pump failure with no active shutdown of the plasma source or control rod insertion. The limiting condition is boiling in the sodium coolant, which precedes fuel melting. The results indicate that the two-thirds reduction in the flow could be accommodated without turning off the plasma source or control rod insertion.

The ability of the first wall to handle disruption loads must also be considered; the current ITER solution is to use a significant amount of copper in the FW as a heat sink. This approach is probably not acceptable for a high-fluence hybrid. Coolants for the other plasma-facing components, such as RF antennae and the shield and vacuum vessel, must also be specified.

SFRs are designed with reactor vessels that have no penetrations below the reactor core and a guard vessel around the reactor vessel, so that LOCAs can be considered to be beyond the design basis. The geometry of hybrid blankets makes it impossible to preclude the potential for LOCAs that would completely drain coolant from the core. No passive safety systems to remove decay heat appear to be viable, and active forced-gas circulation would likely encounter challenges in providing uniform heat removal and preventing localized melting and relocation of fuel.

5.2.3 Separate Fusion Tritium Breeding Blanket and External Fission Blanket

At least one recent hybrid proposal, the fusion-fission transmutation system (FFTS⁸), proposes to decouple the fusion neutron source from the fission blanket so as to avoid the additional complexity, access restrictions, and safety implications of combining the fusion and fission blanket systems inside the magnetic fusion vacuum vessel directly adjacent to the plasma. See Figure 3.

The blanket system strategy taken in this approach is as follows:

1. Make the neutron source a small (~50-100 MW), normal-conducting ST easily replaceable as a unit
2. Make the midplane outboard radial build (including thin first wall, lead multiplier, steel vacuum vessel, aluminum toroidal field magnet legs) relatively permeable to fusion neutrons so they can escape the fusion device with an average energy (~1-2 MeV); and inexpensive, easily replaceable, and essentially disposable since it sees the most damage from fusion neutrons

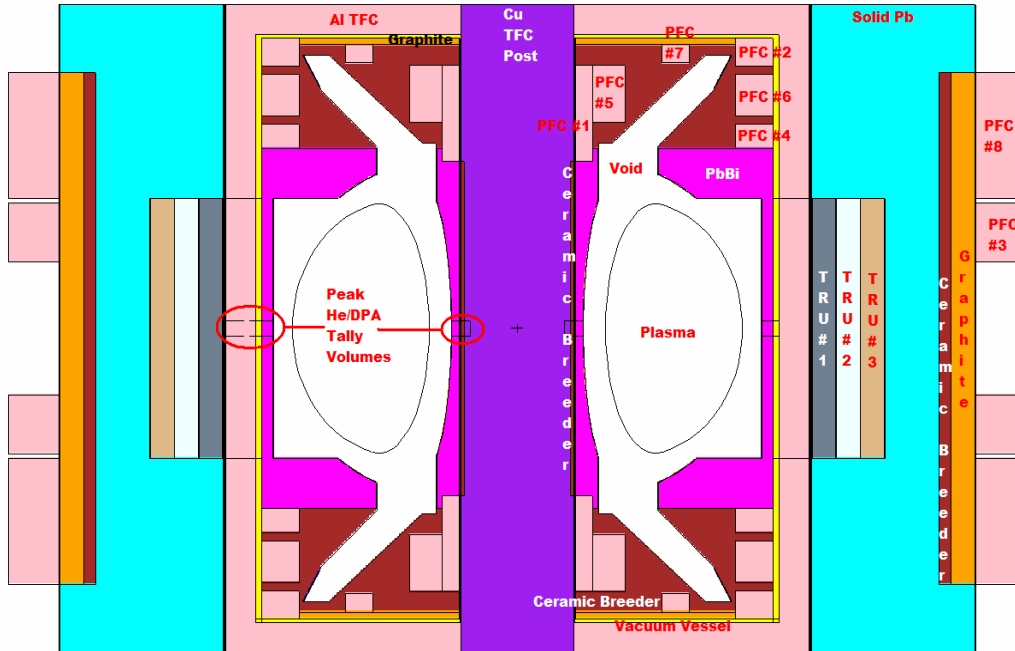

Figure 3. Cross-section of UT concept, the Fusion-Fission Transmutation System (FFTS).

3. Outside the fusion device, surround the midplane with a “relatively standard” fast-spectrum fission blanket in a region that is both accessible and isolated from plasma disruption effects
4. Locate the plasma fueling, heating, and control system off the midplane above and below the plasma
5. Surround the copper alloy center-post and poloidal field (PF) magnets above and below the outboard midplane with sufficient shielding and a tritium breeding material to meet tritium self-sufficiency needs and lifetime requirements for PF magnet systems (~5-10 years)
6. Completely swap out the fusion ST core with a replacement every 1 to 2 years (same time scale as fission blanket fuel shuffling) and refurbish the fusion core for redeployment during next scheduled outage

For near-term applicability, suitable steels are used as a construction material — perhaps reduced-activation alloys being developed and tested in the fusion program could be used later. Components exposed to fusion neutron fluence greater than $\sim 3 \text{ MW}\cdot\text{yr}/\text{m}^2$ will be replaced, and so current-generation steels are expected to be adequate.

The neutron wall load for 100 MW of fusion power is roughly $1 \text{ MW}/\text{m}^2$, similar in scale to ITER midplane values. The steady-state surface heat flux is expected to be in the average range of $\sim 0.25 \text{ MW}/\text{m}^2$. The FFTS addresses the serious divertor heat flux issue associated with an ST by using the Super-X divertor geometry. Simulations of the divertor plasma indicate that a peak heat flux on the divertor can be reduced to $3 \text{ MW}/\text{m}^2$

— a value that is expected to allow near-term divertor plate technology with water cooling. The operating temperatures of the components in the fusion systems can potentially be more flexible than in a pure fusion reactor, since the fusion power is a small fraction of the fission blanket power and can potentially be discarded. These temperatures can be selected to best accommodate radiation damage effects, corrosion, radiation creep, tritium permeation, and related concerns. The fission blanket is located outside the toroidal field (TF) coils, and the TF coils have added toroidal bracing (making the outboard TF system look like a cage) so that the TF can isolate disruption effects from the fission blanket outside.

The strategy taken in this approach — allowing the neutrons to leave the fusion system — results in the highest radiation damage to the outboard vacuum vessel and TF coil legs. This approach is a paradigm shift from fusion power plant designs that typically treat these components as lasting the lifetime of the plant because of cost and availability considerations. Instead, these components are expected here to be damaged, removed, and replaced every 1 to 2 years, based upon the anticipated lifetime of the material used. Rewelding/reattachment of the replacement components in regions of the fusion core that permit rewelding (that is, those that sustain an acceptable level of helium build-up from neutron damage) is anticipated, but these sites have not been fully identified, nor has their reweldability been evaluated in terms of the local radiation damage. Replacement of upper, lower, and inboard components, including the lead blanket/shield, tritium breeding regions with Li_2TiO_3 , poloidal field coils (including those needed for the Super-X divertor), divertor plates, and plasma heating, current drive, and control hardware will also be needed to maintain the required reliability for in-vessel fusion components. An approximate lifetime of 10 years has been suggested in various presentations. However, both the economics of this frequent-replacement strategy and the resultant waste stream details, including insulator materials and aluminum used in the magnet systems, must be better quantified.

Regarding the fission blanket system, the containment wall that faces the neutron source has the highest damage rate, about one-third that of the fusion first wall, but the helium production is significantly smaller, as is typical of fission spectrum. The remainder of the fission blanket, being completely separated physically from the fusion neutron source and having a design and power density similar to typical fission fast-reactor systems, would presumably have damage and lifetime characteristics commensurate with current fission systems. The complexity of the design may be slightly increased by the annular geometry, but the access and procedures for using control elements and performing fuel reshuffling should also be similar to those for fission.

The FFTS sizes the fusion power to allow subcritical operation and would maintain k_{eff} below unity, even in a LOCA where the fission core coolant is completely voided. However, as discussed for SABR it is difficult to completely guard against the occurrence of a LOCA. While the location of the fission blanket outside the fusion core and the vertical placement of fuel pins may allow for easier access and flow for an auxiliary gas coolant system, in general, it appears to be extremely challenging to implement an effective ECCS system for a fixed-fuel hybrid.

Disruption loads are always an important issue in a tokamak device, but the placement of the fission blanket outside the TF coils (although still inside a set of midplane PF coils) and the special design of the TF system to help shield disruption loads should reduce concerns of fission fuel damage or coolant loss during disruptions. Estimates indicate that the EM loads are reduced by an order of magnitude compared to blanket systems inside the TF system, and thermal loads are completely isolated from the fusion first wall and divertor systems. Disruption effects on the fusion systems are calculated to be somewhat less than with ITER. However, again similar to the SABR discussion, the ITER solution to the thermal load is to place a significant amount of copper heat sink at the first wall. It should be noted that the complexity of multiple coolant systems must also be considered in view of accident and failure frequencies and modes.

5.2.4 Dissolved Fuels and Fission-Suppressed Fuel Factories

A variety of fusion reactor concepts have called out the advantages of using liquid blankets, and even liquid first walls. Typically, molten salts (such as Flibe) or lead-lithium are envisioned. Such systems can be adapted to hybrid operation by dissolving fuel in the molten salt or liquid metal flow, without the addition of any new engineering systems in the vacuum vessel close to the plasma. This dissolved fuel can be fertile material for breeding of fissile fuel that is continuously removed and used for fueling light water reactors (LWRs) without need for enrichment. This type of fuel breeder blanket was the subject of considerable engineering work in the past¹¹⁻¹³. An example shown in Figure 4 uses Th-232 to produce U-233 in a thermal spectrum in either a mirror or tokamak. The U-233 is continuously removed online to provide a fuel supply for multiple LWRs. Owing to the removal of fissile isotopes, these “fission suppressed” systems have reduced thermal energy multiplication compared to other hybrid concepts, but they also have increased revenue because of the sale of fissile fuel to LWRs. The neutron wall load can be smaller than in pure fusion, perhaps 2 MW/m² as noted in several past designs, but it is larger than in some other hybrid proposals where higher energy multiplication is a goal. Fission fuel factory systems have been previously reviewed in detail²¹.

Many variants using dissolved fuels with different multipliers and coolants, have been developed and described in the literature; see, for example, the analysis in References 5 through 7. An advantage for these fuels is that low-Q plasmas could be more easily hybridized without any new engineering systems close to the fusion core, by simply dissolving low percentages (~1-10%) of U, Th, or Pu fluorides in the liquid fusion blanket. When molten salt concepts were extensively studied in the 1980s, the molten salt technology, such as processing of uranium out of the thorium-laden molten salt by fluorination, was thought to be well known. However, in recent decades molten salt technology has been somewhat forgotten and must be relearned. In general, mobile fuels may offer benefits to overcome access, geometric restrictions, and fuel damage due to fusion conditions; however, concerns must be addressed regarding licensing and IAEA safeguards in the current regulatory environment. Licensing is already a challenge for mobile particle fuels such as in the pebble bed reactor.

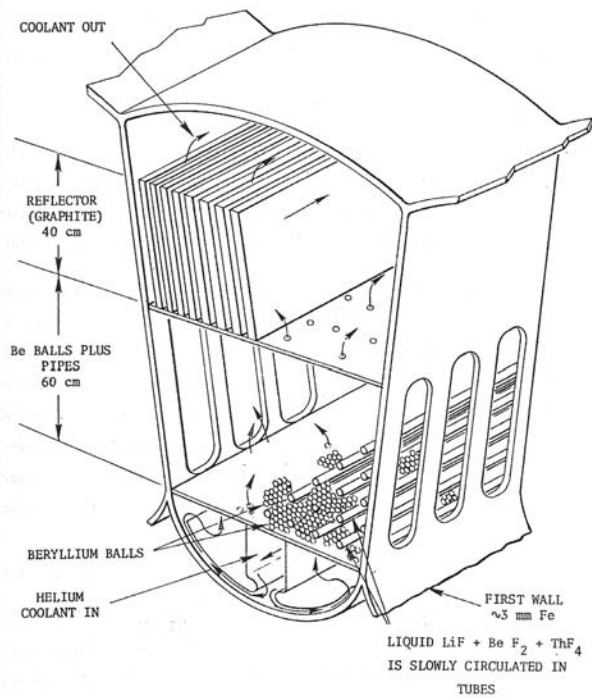

P_{nuclear}	4440 MW
P_{fusion}	3000 MW
$P_{\text{alpha particle}}$	600 MW
P_{blanket}	3840 MW
P_{electric}	1380 MW _e
$P_{\text{wall load}}$	2 MW/m ²
Length of blanket	127 m
First wall radius	1.5 m
F_{net}	0.6
M^{a}	1.6
Fissile production	6380 kg ²³³ U/yr at 80% capacity factor
Total cost	\$4867M

^a F_{net} is fissile atoms bred/tritium consumed; M is the energy released in the blanket per tritium consumed divided by 14 MeV.

Figure 4. Fission-suppressed hybrid blanket based on beryllium pebbles and dissolved thorium in Flibe.

It is also worth noting that thick “liquid wall” blankets¹⁴ can absorb neutrons, change plasma/wall interactions through beneficial gettering, and mitigate damage from pulsed loading, and they also have no neutron damage issues (assuming that solid structural elements are sufficiently shielded). Adapting such designs to hybrids also appears possible, with complications beyond those for their implementation in pure fusion systems (such as processing systems and containment), occurring away from the burning plasma or target explosion. However, the burden of establishing the thick liquid flow is not reduced and still must be developed and demonstrated.

5.3 Summary

Findings and recommendations regarding hybrid blankets and fusion/fission technology are summarized below and are reported as well in the chapters on findings and research needs (Chapters 9 and 10).

5.3.1 Findings of the Hybrid Blanket Panel

1. **Developing hybrids:** Developing hybrids will require substantially the same types of research and development as needed for pure fusion (plasma facing components, blankets, materials, etc.) as well as that needed for new fission fuels and safety. This

is a key area for further evaluation, as the ultimate feasibility and attractiveness of the hybrid will rest largely on these technological systems.

2. **Potential benefits of hybrid blankets vs. pure fusion blankets:** There can be economic, reliability, development cost/time, and risk reduction benefits of hybrids when compared to pure fusion energy blanket systems. These potential benefits stem from two main avenues: (1) energy and neutron multiplication behind the first wall leading to reduced fusion neutron wall load and surface heat load that may ease neutron damage or thermomechanical load; and (2) driver selection and operation with a reduced number or intensity of disruptions and ELMS that may ease the maintenance and replacement of components. However, not all hybrid concepts attempt to realize these potential benefits, instead pursuing other goals. Concepts will have to be analyzed individually to assess their merits.
3. **Technological readiness of hybrid blankets:** The technological readiness of blanket systems for the fusion-fission hybrid is behind that of the fission analogs. Qualification of these blankets will take at least 20 years based on fission experience, and would require similar integrated test facilities as needed in both pure fusion and fission development. Whether the development time scale is longer or more rapid than for pure fusion cannot be firmly concluded without further extensive analysis. There is concern by some in the fusion community that the development aspects of the hybrid blanket related to complexity, reliability, maintainability, safety, and high burn-up fuels may be significant.
4. **Safety of fusion-fission hybrids:** The burden of proof associated with the safety case for the fusion-fission hybrid will be much greater than for pure fusion given the hazards associated with the fission materials (such as transuranics and fission products), the more complex geometries (torus inside vacuum vessel) and conditions (magnetic field, radiation damage in vessel), and the unique energy sources associated with fusion (plasma and magnetic field).
5. **Fission blankets outside the vacuum vessel and magnets:** The strategy of completely removing the fission blanket to a region outside the TF coils of the fusion device is a paradigm shift from fusion power plant designs that has several potential advantages. However, detailed implications regarding the degree of parasitic neutron absorption, access for plasma support systems, the ability to meet tritium production requirements, and the economics and waste disposal must be fully analyzed to confirm its viability.
6. **Fission blankets inside the vacuum vessel and magnets:** The attempt to put near-term fixed fuels or utilize existing fission fast reactor blanket designs inside the fusion vacuum vessel adjacent to the plasma appears very difficult from the perspectives of fuel loading, shuffling, unloading; LOCA response; and fuel or coolant interactions with magnetic fields and disruptions. Mobile fuels may offer benefits to overcome access, geometric restrictions, and fuel damage due to fusion conditions, but concerns must be addressed regarding the current stage of development, licensing and IAEA safeguards in the current regulatory environment. However, hybrid licensing will be a challenge in any case, as all hybrid variants represent new nuclear technologies.

5.3.2 Research Needs Noted by the Hybrid Blanket Panel

1. **Fusion-fission hybrid blanket neutronics:** The ability to simultaneously meet tritium breeding requirements and fission fuel breeding or transmutation goals claimed by the advocates must be based on conceptual designs and neutronics analysis, including more complete structure, coolants, penetrations, plasma fueling/control systems, and so on, including time variations coming from fuel burn-up and reduced reactivity. A consistent degree of detail and analysis will be needed to compare potential hybrid concepts.
2. **Fusion technology and materials research:** The desired use of sodium, lead, and other liquid metal coolants; molten salt coolants; radiation-resistant structural materials and cladding; high-temperature gas cooling; radiation-resistant insulators and diagnostics; all represent technological areas of overlap between pure fusion, fission, and hybrids. Joint R&D in these critical areas affecting thermal-hydraulics and safety could draw upon capabilities and produce benefits in both communities, and inform the advancement of hybrid concepts.
3. **Fuels research:** Fuel forms considered for fission applications such as pebble fuels, metal fuels, inert matrix fuels, and dissolved fuels are also identified for possible use in hybrids. Research on techniques to extend burn-up in critical and subcritical systems, and unique aspects of these fuels in a fusion environment, such as magnetic field interactions for magnetic fusion and pulsed load effects for inertial systems, are important areas in which to assess fuel use in hybrids and increase the fuel database for fission.

References

1. R.P. Abbott et al., Thermal and Mechanical Design Aspects of the LIFE Engine, Fusion Science and Technology, Vol. 56, No. 2, 618-624 (2009)
2. D. H. Berwald, et al., "Fission Suppressed Hybrid Reactor –The Fusion Breeder", Lawrence Livermore National Laboratory, Livermore, CA, UCID-19638 (1982).
3. L. Buiron, Ph. Dufour, G. Rimpault, G. Pruhliere, C. Thevenot, J. Tommasi, F. Varaine, A.Zaetta, Paper#7383, International Conference on Advances in Power Plants (ICAPP) Nice, France, 2007.
4. J. Caird et al., Nd:Glass Laser Design for Laser ICF Fission Energy (LIFE), Fusion Science and Technology, Vol. 56, No. 2, 607-617 (2009)
5. Edward Cheng, "PERFORMANCE CHARACTERISTICS OF ACTINIDE-BURNING FUSION POWER PLANTS," Fusion Science and Technology 47 (2005) 1219-1223.
6. B. Cipiti et al., The Role of Z-Pinch Fusion Transmutation of Waste in the Nuclear Fuel Cycle, SAND2007-6487, October 2007.
7. Y. Gohar, "Fusion solution to dispose of spent nuclear fuel, transuranic elements, and highly enriched uranium" Fusion Engineering Design, 58-59, 1097 (2001).
8. M. Kotschenreuther, P.M. Valanju, S.M. Mahajan, E.A. Scheider, Fusion-Fission Transmutation Scheme – Efficient destruction of nuclear waste, Fusion Engineering and Design, 84 (2009) 83-88.

9. K. J. Kramer et al., Neutron Transport and Nuclear Burnup Analysis for the Laser Inertial Confinement Fusion-Fission Energy (LIFE) Engine, *Fusion Science and Technology*, Vol. 56, No. 2, 625-631 (2009)
10. W. R. Meier et al., Systems Modeling for the Laser Fusion-Fission Energy (LIFE) Power Plant, *Fusion Science and Technology*, Vol. 56, No. 2, 647-651 (2009)
11. R. W. Moir et al., "Fusion Breeder Reactor Designs" *Nuclear Technology/Fusion*, 4 (1983) 589-598.
12. R. W. Moir, et al., "Feasibility Study of a Fission-Suppressed Tokamak Fusion Breeder", Lawrence Livermore National Laboratory, Livermore, CA, UCID-20154 (1984).
13. R. W. Moir, et al., "Helium-Cooled Molten Salt Fusion Breeder", Lawrence Livermore National Laboratory, Livermore, CA, UCID-20153 (1984), 204 pages. A small version of the above report appears in *Fusion Technology*, 8, 1985, 8 pages.
14. R. W. Moir et al., Molten Salt Fuel Version of Laser Inertial Fusion Fission Energy (LIFE), *Fusion Science and Technology*, Vol. 56, No. 2, 632-640 (2009)
15. R. W. Moir, R. L. Bieri, X. M. Chen, T. J. Dolan, M. A. Hoffman, et al., "HYLIFE-II: A Molten-Salt Inertial Fusion Energy Power Plant Design-Final Report," *Fusion Technology*, 25, 1 (January 1994) 5-25.
16. R. W. Moir, R. H. Bulmer, K. Gulec, P. Fogarty, B. Nelson, M. Ohnishi, M. Resnick, T. D. Rognlien, J. F. Santarius, and D. K. Sze, "Thick Liquid-Walled, Field-Reversed Configuration Magnetic Fusion Power Plant," *Fusion Technology*, 2, 2, Part 2 (March 2001) 758.
17. E. I. Moses et al., A Sustainable Nuclear Fuel Cycle Based on Laser Inertial Fusion Energy, *Fusion Science and Technology*, Vol. 56, No. 2, 547-565 (2009)
18. P. F. Peterson et al., Overview of Fission Safety for Laser ICF Fission Energy, *Fusion Science and Technology*, Vol. 56, No. 2, 641-646 (2009)
19. G. E. Rochau, and the Z-Pinch Power Plant Team, "Progress Toward the Development of an IFE Power Plant Using Z-Pinch Technology," *Fusion Science and Technology*, 47, 3 (April 2005) 641.
20. Stacey, W.M. et al., "A TRU-Zr Metal-Fuel Sodium-Cooled Fast Subcritical Advanced Burner Reactor," *Nuclear Technology*, Vol 162 (2008).
21. J. Simpson, Chair, Outlook for the fusion hybrid and tritium breeding fusion reactors, National Academy Press, Washington DC, 1987
22. D. Steiner and the ARIES Team, The ARIES Fusion Neutron Source Study, UCSD-ENG-0083, 2000.
23. T. S. Sumner, W. M. Stacey and S. M. Ghiaasiaan, DYNAMIC SAFETY ANALYSIS OF THE SABR SUBCRITICAL TRANSMUTATION REACTOR CONCEPT, submitted to *Nuclear Technology*, 2009.
24. M. Ubeyli, "Potential use of molten salts bearing plutonium fluorides in a magnetic fusion energy reactor", *Annals of Nuclear Energy*, 35, 1087 (2008).
25. S.C. Wilks et al., Evaluation of Several Issues Concerning Laser Beam Propagation Through the LIFE Target Chamber, *Fusion Science and Technology*, Vol. 56, No. 2, 652-657 (2009)

Chapter 6

Alternative Approaches

A. Machiels (Chair), J. Kessler, G. Rochau, R. Sheffield, P.N. Swift

6.1 The United States Situation

Current civilian use of nuclear power in the United States is based on a once-through fuel cycle involving the irradiation of low-enriched uranium fuel in light water reactors and the subsequent storage and eventual disposal of the used fuel without reprocessing. However, expanded use of nuclear power globally may be predicated on economic competitiveness and sustainability, which in turn may require consideration of different fuel cycles.

The May 2001 National Energy Policy Report (NEPR), developed by the National Energy Policy Development (NEPD) Group, recommended that “in the context of developing advanced nuclear fuel cycles and next-generation technologies for nuclear energy, the United States should re-examine its policies to allow research, development and deployment of fuel conditioning methods that reduce waste streams and enhance proliferation resistance.”

One outgrowth of the NEPR was the initiation of the Advanced Fuel Cycle Initiative (AFCI) within the U.S. Department of Energy (DOE). The AFCI mission is to develop fuel cycle technologies that meet the need for economic and sustained nuclear energy production while satisfying requirements for a proliferation-resistant nuclear materials management system.

In February 2006, the DOE also created the Global Nuclear Energy Partnership (GNEP). One of the main program elements focused on increasing the efficiency of managing used nuclear fuel and deferring the need for additional geologic nuclear waste repositories until the next century. The GNEP proposed that commercial used fuel eventually be recycled in advanced burner reactors so that transuranic elements would be consumed, not disposed of as waste.

Almost immediately following the inauguration of President Obama in January 2009, the GNEP program was canceled, but support for the AFCI program was re-emphasized. The Obama administration also announced in March 2009 that the proposed permanent repository at Yucca Mountain “was no longer an option,” and that a “blue-ribbon commission” would be created to evaluate alternatives to Yucca Mountain. As of the end of October 2009, the commission has yet to be formed.

Creation of the commission would provide an opportunity for reaching consensus on how advanced nuclear fuel cycles should factor into long-term energy planning at the national level. Reprocessing and fuel cycle closure are complex topics with many competing issues — economic, technical, and institutional — that must be closely examined and properly communicated. Further, because of the substantial time and resources required to successfully demonstrate, license, and deploy advanced fuel cycle facilities, an optimum solution path is not evident at this time.

6.2 The Global Situation

Assuming that reliance on nuclear power will significantly expand in the future, present and future global developments of the nuclear fuel cycle — as anticipated by the “fission community” — are shown in Figure 1. The fuel cycle is divided in four blocks: the top two (LWR [Light Water Reactor] Power Block and Managed Storage) have been in commercial operation for several decades; the bottom one (FBR [Fast Breeder Reactor] Power Block) is receiving strong R&D support, especially in France, Russia, India, Japan, and China. Finally, significant progress is being made related to Geologic Repository (or HLW [High-Level Radioactive Waste, including spent fuel in some cases]),” especially in Finland, Sweden, and France.

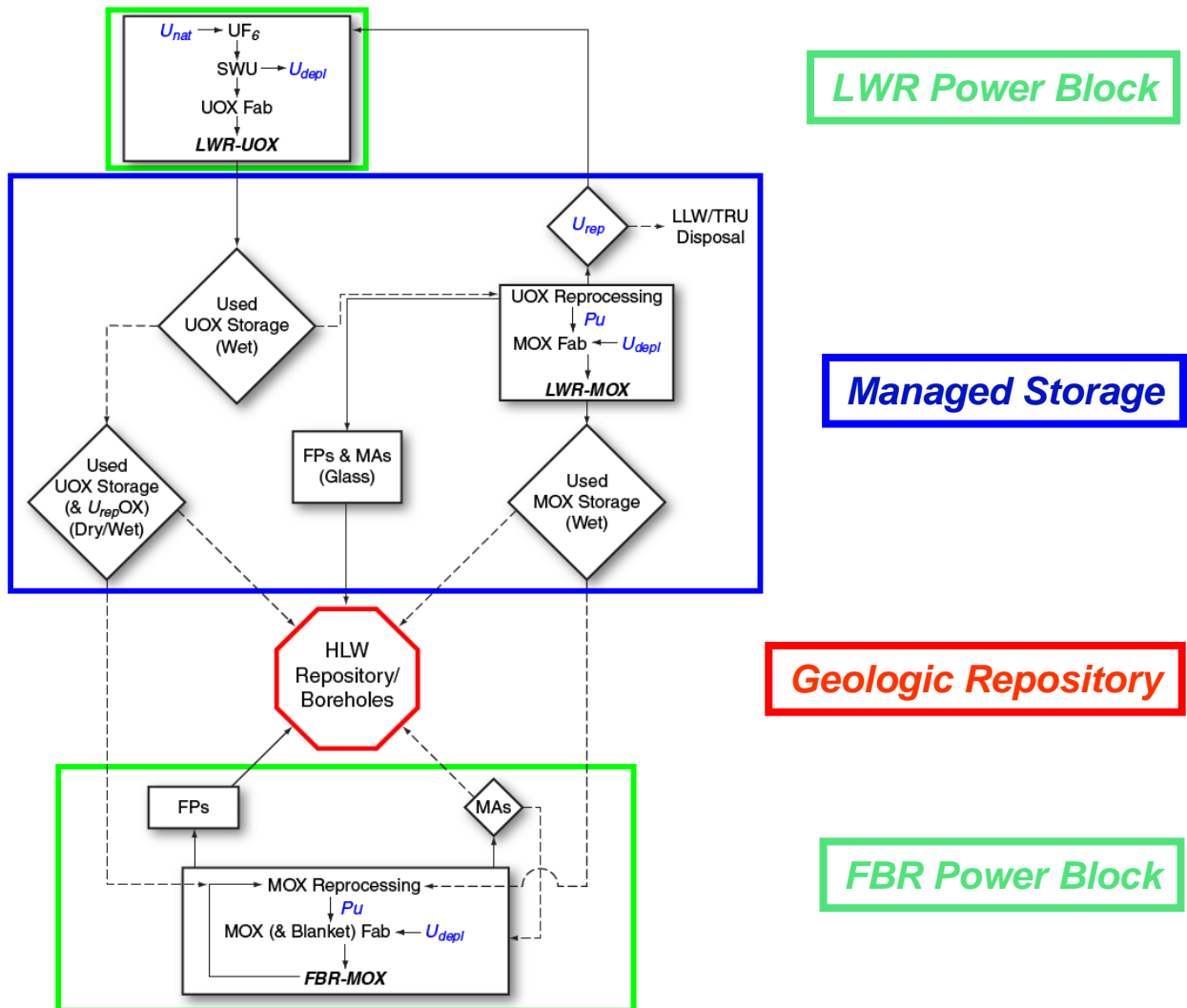

Figure 1: Present (LWR Power Block and Managed Storage), anticipated (Geologic Repository), and potential (FBR Power Block) nuclear fuel cycle elements.

Several generic scenarios are considered in Chapter 3 of the report. In this chapter, entitled “Alternative Approaches,” nuclear power is assumed to be an important, long-term contributor to electricity supply in a carbon-constrained world. The aim of the retained scenarios is to improve the sustainability of nuclear energy by enhancing the effectiveness of natural uranium resource use and by mitigating waste disposal issues, while keeping the costs of energy products, in particular electricity, economically viable.² In these scenarios, plutonium-239 is generally considered an important resource for achieving this sustainability objective.

LWR Power Block

More than 85% of the installed nuclear capacity consists of pressurized and boiling water reactors (BWRs). The head-end infrastructure (uranium mining and milling, conversion, enrichment, and fuel fabrication) is well established. The LWR technology makes very limited use of the potential energy content of natural uranium resources by using less than 1% of the mined uranium.

Managed Storage

The fuel discharged from LWRs is either placed in interim storage for several decades (as in the United States, Sweden, Finland, South Korea, Taiwan, Canada, Brazil, Argentina, and many other countries), or reprocessed (France and Japan). Interim storage of used LWR fuel has been implemented in centralized facilities (Sweden) or at the reactor sites (United States). Reprocessing employs the plutonium and uranium extraction (PUREX) process and results in three main products: reprocessed uranium, reactor-grade plutonium, and wastes. The reprocessed uranium and plutonium can be recycled in existing LWRs, resulting in potential natural uranium savings of up to about 25%. The used fuel derived from using recycled uranium or plutonium is then placed in interim storage. Among the different waste streams, vitrified HLW, containing the fission products and the minor actinides neptunium, americium, and curium dispersed into a glass matrix, is also placed in interim storage. The end result for both options is thus interim storage. The technology and facilities to implement interim storage, including reprocessing³ and fuel refabrication, have been deployed at commercial scale.

FBR Power Block

By recovering the plutonium available in used fuel, use of U-238 can be fully enabled in fast reactors: the plutonium is consumed and regenerated from the U-238. The leading design is the sodium-cooled fast reactor operating in the near-breeder or breeder mode. Reprocessing of used FBR fuel and refabrication are required. Depending on the reprocessing scheme, separation and transmutation of some long-lived fission products and minor actinides can be contemplated. The largest operating fast reactor is presently the Russian BN-600 (1470 MWth), fueled with enriched uranium and operating since 1980. An advanced design, the BN-800 is scheduled for operation in 2016 and will be

² In addition, this aim has to be achieved under conditions that minimize the risks of diversion of separated fissile materials and their possible misuse for non-peaceful ends [Reference: *Advanced Nuclear Fuel Cycles and Radioactive Waste Management*, OECD 2006, NEA No. 5990, page 18].

³ See Appendix A: Reprocessing

fueled with mixed uranium and plutonium oxide. First criticality of the 65-MWth China Experimental Reactor (CEFR) is expected this year.⁴ Re-start of the 714-MWth Monju reactor in Japan is scheduled by the end of March 2010. Initial criticality of a 500-MWe prototype fast breeder reactor (PFBR) in India is scheduled by the end of 2010.

Advanced reprocessing technologies based on the PUREX process are being developed in several countries. The two main options being pursued are selective separation of minor actinides for heterogeneous⁵ recycling in fast reactors and group actinide separation intended for homogeneous⁶ recycling in fast reactors. Also, innovative methods based on pyrochemistry are being developed as integral parts of the refueling/waste management system of specific types of fast reactors. These methods allow for the treatment of different types of highly radioactive fuels with high plutonium content. Commercial deployment of these technologies is not likely for several decades. The French program anticipates commercial deployment of a fast reactor fleet possibly as early as 2040; a preliminary proposal integrating fast reactor, reprocessing, and waste management technologies is scheduled for 2012, with an operating fast reactor prototype in 2020.

Geologic Repository

All options require a geologic repository. There is broad agreement among the technical community that deep geological disposal constitutes a safe option for the relatively small volumes of HLW (including used fuel) generated by the nuclear power plants. The safety case for an HLW repository requires extensive R&D (regarding site suitability and waste packaging, for example), because the final selection of a site and disposal concept will be challenged from every possible angle. However, technical issues are generally not the limiting timing factors. Societal and political acceptance of these systems is currently the limiting factor for implementation in most countries. In this regard, the way Finland sought and obtained public support for its program is widely regarded as a good model [Reference: "Timing of High-Level Waste Disposal," OECD 2008, NEA No. 6244 (2008)]. Finland, Sweden, and France appear to be on a robust path to have an operating geologic repository by 2025, or sooner.

6.3 Discussion

6.3.1 Natural Resource Use

Worldwide, the primary driver for the deployment of the advanced nuclear fuel cycle facilities shown in Figure 1 is the promise to cost-effectively unlock the energy content of U-238, should the price of natural and enriched uranium progressively escalate to levels that would make the LWR technology noncompetitive. In this case, the economic potential of plutonium (and more specifically Pu-239) becomes very high, and fast reactors would operate in near-breeding or breeding mode. Plutonium (associated with

⁴ A high-level agreement has been signed for Russia to start pre-project and design work for two commercial 800-MWe fast neutron reactors in China.

⁵ Meaning that the minor actinides and nuclear fuel are packaged separately

⁶ Meaning that the minor actinides are incorporated into the nuclear fuel

depleted uranium) is an effective fuel for fast breeder reactors. Plutonium can be recycled indefinitely and produces low levels of Pu-241 and Pu-242, which, in turn, results in small amounts of americium and curium. Therefore, multi-recycling of plutonium in fast reactors also has benefits with regard to minimizing the production of minor actinides.⁷

There are several alternatives to the sodium-cooled fast reactors. Among the most prominent are those that are the subjects of cooperative R&D in the context of the Generation IV International Forum [Reference: GEN IV International Forum – 2008 Annual Report]. These include:

1. Lead-cooled fast reactors
2. Gas-cooled fast reactors
3. Molten-salt thermal and fast reactors

Recent developments in breeder reactor designs also include innovative designs such as Hitachi's resource-renewable boiling water reactor, a fast reactor relying on existing thermal BWR technology, and TerraPower's traveling wave reactor (TWR), which belongs to a class of reactors that promotes maximum fuel use in fast reactors without chemical reprocessing.

For completeness, the fissile Pu-239–fertile U-238 scheme can be augmented by a fissile U-233–fertile Th-232 scheme. In all reactor-based cases, however, U-235 is needed to create a sufficiently large inventory of either Pu-239 or U-233 before breeding becomes possible.

It should also be mentioned that accelerator-driven systems (ADSs), which will be presented in the following section for their potential benefits to waste management, can also be envisioned for breeding of fissile material, independently of the need to first rely on U-235.

When natural resource use is not the main concern, because of abundant uranium supply relative to potential demand, other fuel cycle schemes have been investigated for reduction of the waste management burden, for proliferation resistance and physical protection, or both.

The technical and economic conditions for breakthrough of these advanced systems by midcentury are challenging. Such advanced fuel cycles encompass not only reactors, but also dedicated fuel fabrication and recycling facilities. These elements are closely interdependent and their performance must be consistent. These systems will take part in the renewal of the existing reactor fleet only if they can provide advantages first of all with regard to safety, operational conditions, economic competitiveness, and waste management in the long term. This competitiveness may be anticipated on paper, but it will have to be proven by experience. The risks incurred by utilities are of such nature and seriousness that the utilities must carefully scrutinize R&D results and operating experience before making any decision leading to industrial deployment. For this reason,

⁷ Multiple recycling of mixed Pu/U fuel in LWRs is not a practical option for a number of reasons related to the build-up of largely non-fissile actinides and reactor safety issues.

it is anticipated that advanced light water reactors (ALWRs) will stay in close economic competition for a long period of time.

6.3.2 Waste Management

Detailed safety assessments are available for potential repository concepts in multiple geologic settings (such as clay in France [Figure 2] and volcanic tuff in the United States [Figures 3 and 4]), including estimates of long-term performance for both used fuel and vitrified reprocessing wastes. Depending on the assessment, dose estimates for sites in oxidizing environments (such as Yucca Mountain) are dominated either by long-lived transuranic radionuclides, including Pu-242 and Np-237 (Figure 3), or by a combination of long-lived fission products (Tc-99 and I-129) and actinides (Np-237 and U-233; see Figure 4). For disposal concepts in reducing environments with slow diffusive transport pathways (such as the Meuse/Haute-Marne clay site evaluated in France [Figure 2]), transuranic elements are essentially immobile, and mobile species such as Cl-36 and I-129 are the only significant contributors to long-term dose. Since the dose estimates for different repository concepts and different waste types (such as commercial spent nuclear fuel or vitrified high-level wastes) are all no more than a few millirem per year, it is difficult to rationalize the need for any additional technical enhancements to further lower the estimated doses. The geologic media themselves do an excellent job of reducing the importance of many of the radionuclides with a high theoretical “radiotoxicity” via solubility limits and sorption on geologic media. These assessments suggest that excellent long-term performance can be achieved, with estimated peak doses to individuals in the biosphere well below regulatory limits and far below natural background radiation doses. This conclusion appears to be robust and independent of waste form: *Assurance of acceptable repository performance does not depend on partitioning or transmutation of specific radionuclides, nor does it appear to require specialized waste forms.* Also, it can be concluded that “radiotoxicity” is a figure of merit possessing limited interest, because it does not take into account nuclide mobility in the geologic environment.

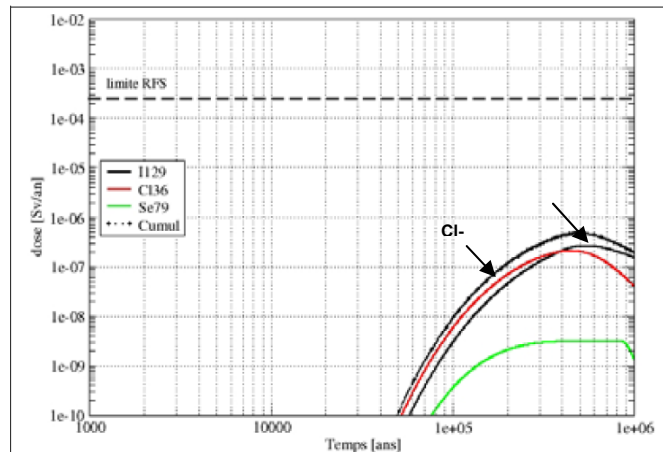

Figure 2. ANDRA results for a clay site. I-129 is the dominant contributor at peak dose (example shown for glass waste only). [Reference: *Dossier 2005: Argile. Tome: Evaluation of the Feasibility of a Geological Repository in an Argillaceous Formation*, ANDRA 2005].

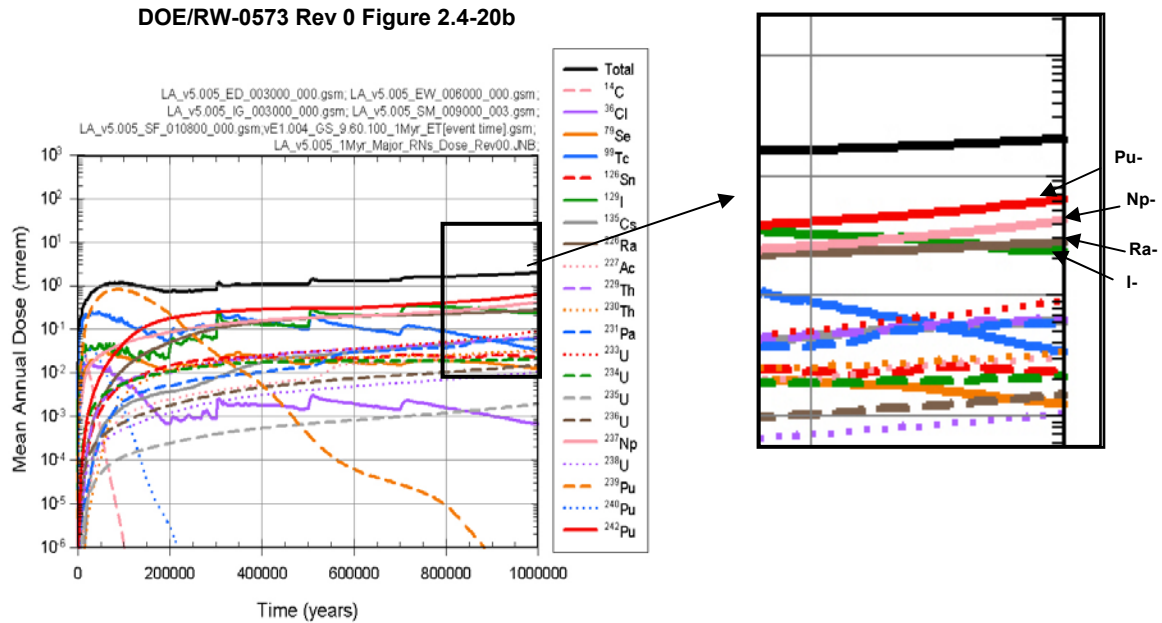

Figure 3. DOE Yucca Mountain results [Reference: U.S. Department of Energy, 2009, *Yucca Mountain License Application*, DOE0R-W 0573, Rev. 1].

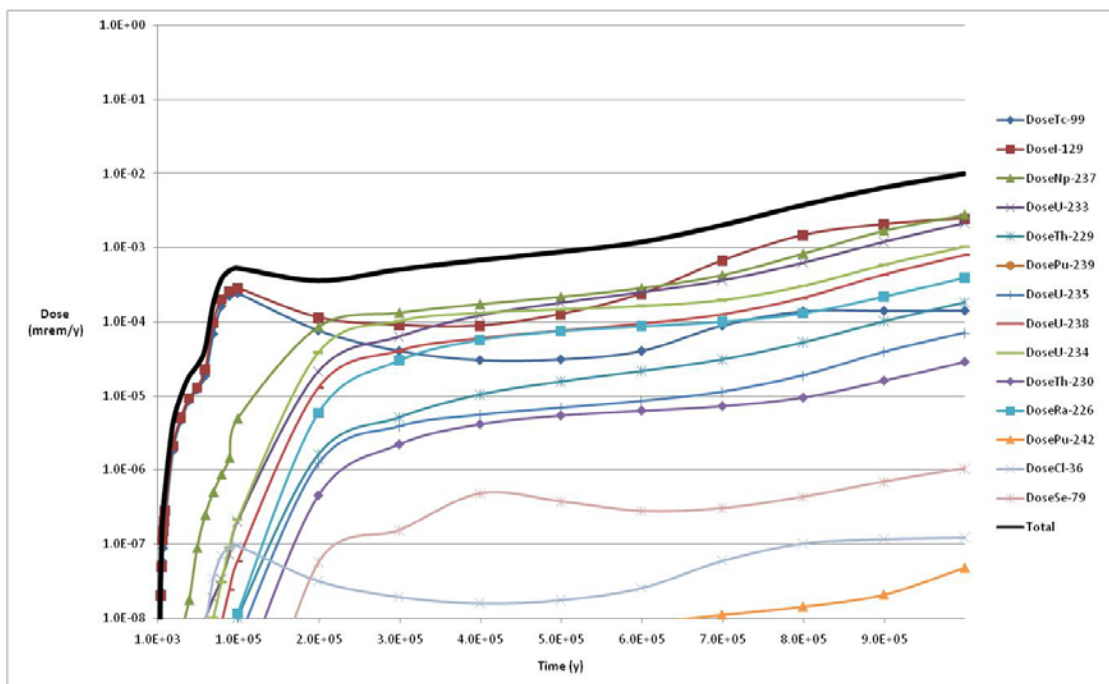

Figure 4. EPRI Yucca Mountain results [Reference: *EPRI Yucca Mountain Total Systems Performance Assessment Code (IMARC) Version 10, Model Description and Analyses*. EPRI, Palo Alto, CA: 2009. 1018712].

Although *not* necessary to assure safe, long-term geologic repository performance, partitioning and transmutation technologies can reduce the waste decay heat burden to be accommodated in the geologic repository. The ability of geologic media to reject the decay heat, along with temperature limitations specified for the repository system, often limit the areal density of waste that can be disposed. Because used fuel and HLW can be allowed to cool in interim storage, decay heat after 100 years is a better figure of merit than radiotoxicity for quantifying waste burden. After 100 years, the main contributors to decay heat are the actinides, especially Am-241. Potential benefits of reducing the size of a repository, or the total number of repositories needed for a given amount of energy production, should be considered both in the context of public acceptance and in the context of comparisons of overall cost and safety among the different strategies under consideration. In addition to partitioning and transmutation of minor actinides, strategies under consideration include repository expansion through waste spacing, drift ventilation, R&D to reduce conservatisms, and separation and storage/transmutation of the high decay heat fission products (Sr-90 and Cs-137 and their daughters). Given the relative simplicity associated with interim storage of used fuel and vitrified HLW for periods of 50 to 100 years, separation of these fission products is no longer seriously considered.

From a waste management outlook, research on partitioning and transmutation of long-lived nuclides is part of a responsible and ethical approach toward good resource management. Optimization studies have to be made at the full system level, considering near-term and long-term worker and public dose consequences, cost (to the government and industry), transportation requirements, technical achievability, regulatory issues, security issues, timeliness of the solution, and capacity for commercialization. For example, compared to standard mixed-oxide (MOX) fuel, minor-actinide-bearing fuels feature a considerable increase in γ and neutron dose and of decay heat. These characteristics will require specific protection and cooling means for manufacturing, handling, and transporting these fuels, together with much longer decay times before unloading, transportation, and further processing. Actively managing such highly radioactive materials in the fuel cycle rather than leaving them in glass canisters is a difficult challenge. The topic was addressed in detail in several studies in the early 1990s by the National Academy of Sciences' Committee on Separations Technology and Transmutation Systems (STATS) [Reference: *Nuclear Wastes – Technologies for Separations and Transmutation*, National Academy Press, Washington, DC, 1996] and by the Electric Power Research Institute (*An Evaluation of the Concept of Transuranic Burning Using Liquid Metal Reactors*, NP-7261, Palo Alto, CA, 1991)] at the request of the U.S. Department of Energy. *It is still highly uncertain that a convincing case can be made on the basis of waste management considerations alone that the assumed benefits of transmutation will outweigh the operation, safety, and security considerations and economic costs.*

Deep Boreholes [References: Beswick, J. 2008. *Status of Technology for Deep Borehole Disposal*. Oxon, UK: Nuclear Decommissioning Authority.]

Radioactive waste in solid form emplaced at the bottom of deep (3–5 km) boreholes in crystalline basement rocks (typically granites) with off-the-shelf oilfield technology could be more effectively isolated from the biosphere than waste emplaced in shallower, mined repositories. The physical transport of radionuclides away from the waste at multi-kilometer depths would be limited by low water content, low porosity, and low permeability of crystalline basement rock; high overburden pressures that contribute to the sealing of transport pathways; and the presence of convectively stable saline fluids. In the last decade, radioactive waste management agencies in Sweden (in 2001) and the United Kingdom (in 2008) have evaluated the feasibility of deep borehole disposal as part of the continued monitoring of alternatives to mined geologic disposal. The dramatic advances in drilling technology have decreased the costs and increased the probability of successfully implementing a deep borehole disposal program for low-volume, highly radioactive waste, yet technical and institutional risks remain to be evaluated and to date only Ukraine has indicated a preference for deep borehole disposal for some of its highly radioactive waste.

Recycling in Fast Reactors

There was general agreement in the early 1990s that it made no sense to develop and deploy liquid metal reactors (LMRs) solely for actinide burning. The fraction of the actinide inventory that could be consumed depends upon the decontamination factor, reactor fuel-cycle parameters, and length of time of LMR operation. Transuranic actinide inventory reduction is enhanced by a low breeding ratio⁸, β , (so that the LMR creates fewer new actinides) and by a high decontamination factor (the inverse of which measures the fraction of actinides lost to waste in the reprocessing cycle). By reference to Figure 5 extracted from the NAS report, it can be seen that the time required to reach an inventory reduction factor of 10, equivalent to burning 90% of the actinides, would be more than 100 years; the time to reach an inventory reduction factor of 100, equivalent to burning 99% of the actinides, would be more than 1,000 years; and the time to reach an inventory reduction factor of 1,000, equivalent to burning 99.9% of the actinides, would be more than 10,000 years. This indicates that the actinide inventory reduction factor that can be achieved in a few centuries is nearer to 10 than 100 or 1,000.

Recycling in Thermal Reactors

The thermal flux of an LWR could be used to transmute the transuranic elements. The following concepts have been the topics of research programs:

⁸ The ratio of the amount of fissile actinides produced to that destroyed in the LMR.

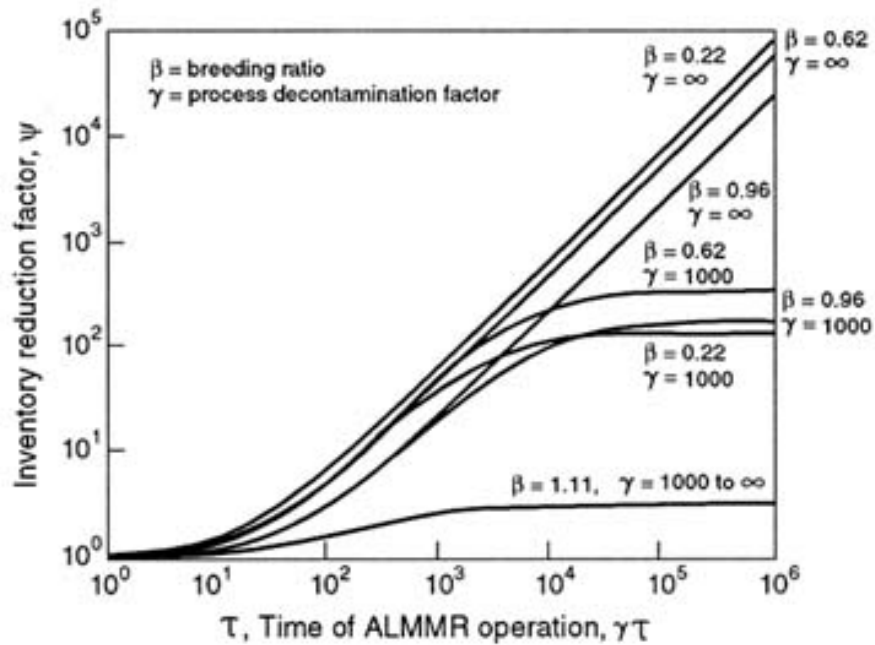

Figure 5: Transuranic inventory reduction factor as a function of liquid metal reactor operation time

1. **Use of inert matrix fuel (IMF)** [Reference: “Viability of inert matrix fuel in reducing *plutonium amounts in reactors*,” IAEA-TECDOC-1516 (2006)]

IMF is a type of nuclear reactor fuel that consists of a neutron-transparent matrix (that is, matrix with a very low neutron absorption cross-section) and a fissile phase that is either dissolved in the matrix or incorporated as macroscopic inclusions. The matrix dilutes the fissile phase to the volumetric concentrations required by reactor control considerations, the same role that U-238 plays in conventional low-enriched fuel. The key difference is that replacing fertile U-238 with a neutron-transparent matrix eliminates plutonium formation as a result of neutron capture.

The use of IMF in the current generation of reactors would provide a means for reducing plutonium inventories. Another application of IMF would be the reduction of minor actinide content, with or without plutonium. As an example, the combined non-fertile and UO₂ (CONFU) fuel concept is an advanced process waste reduction (PWR) assembly that is designed to allow multi-recycling of transuranics in existing PWRs [Reference: Implications of Alternative Strategies for Transition to Sustainable Fuel Cycles, A. Romano et al., Nuclear Science & Engineering, 154, 1-27 (2006)].

Finally, IMF materials are also being considered for Gen IV reactors.

2. **“Deep burn” modular helium-cooled reactors** [Reference: “*Gas Turbine-Modular Helium Reactor (GTMHR) Conceptual Design Description Report*,” Potter, and A. Shenoy, GA Report 910720, Revision 1, General Atomics, July 1996]

The deep-burn, modular helium-cooled reactor (DB-MHR) concept has been proposed by General Atomics (GA) for the purpose of incinerating plutonium, neptunium, and americium nuclides, based on the technologies of the graphite-moderated, gas-turbine, modular helium-cooled reactor (GT-MHR). The essential feature of this transmutation concept is the use of the coated fuel particles (tristructural isotropic, or TRISO fuel) that are considered strong and highly resistant to irradiation. The transuranic fuel formed into TRISO particles can be irradiated for a long time in a thermal system, and thereby a very high transuranic consumption (in particular fissile nuclides) can be expected. This is referred to as a “deep burn.”

Recycling in Accelerator-Driven Systems [Reference: *Accelerator-driven Systems (ADS) and Fast Reactors in Advanced Fuel Cycles*, OECD (2002)]

Accelerator-driven systems (ADSs) combine a particle accelerator with a subcritical core. Most concepts assume accelerators delivering continuous-wave, 10- to 100-MW proton beams with energy around 1 GeV. The protons are injected into a spallation target to produce neutrons for driving the subcritical core. Except for the subcritical state, the core is very similar in construction to that of a critical reactor. It can be designed to be operated either with a thermal or a fast neutron spectrum.

The power of the external neutron source is determined by the design of the subcritical core. For example, for a subcritical core fission power of 3 GW and with the multiplier k_{eff} in a range of 0.95 to 0.98, the accelerator power ranges from 55 MW to 21 MW. Either starting out with a lower k_{eff} or going to deeper burn, again resulting in a lower k_{eff} , would require an increase in the accelerator current and a much larger current swing. Designing any neutron source to drive a large k_{eff} swing results in inefficient use of the initial neutron source investment for a substantial fraction of the cycle.

The potential for the transmutation of transuranics of the ADS system is very similar to the potential of fast reactors. A comparison of accelerator-driven subcritical and critical reactor systems is given in Table 1, extracted from the 2002 OECD reference.

Advances have been made since the 2002 OECD reference, with significant improvements in acceptable beam interruption frequency and accelerator reliability. As indicated in Table 1, intermittent operation affects the quality of the power produced by the transmuter, and transients can affect the lifetime of components in the subcritical assembly. The effect of transients on materials and fuels was evaluated at Los Alamos National Laboratory for the proposed Material Test Station [Reference: E. Pitcher, et al., *Progress on the Materials Test Station*, PHYSOR08 (Proc. of the Int. Conf. on the Physics of Reactors, Interlaken, Switzerland, 2008), log 574]. The studies show no significant deleterious effects for core clad or structural materials for the expected accelerator interruptions, and no concern for fuels based on data from other studies.

	Advantages of accelerator-driven systems	Disadvantages of accelerator-driven systems
Design and operation	<ul style="list-style-type: none"> ◆ The possibility to operate a reactor core at a <i>neutron multiplication factor below 1</i> opens opportunities for new reactor concepts, including concepts which are otherwise ruled out by an insufficient neutron economy ◆ In particular, this allows transmuters to be designed as <u>pure TRU or MA burners</u> and hence the fraction of specialised transmuters in the reactor park to be minimised ◆ The proportionality of the reactor power to the accelerator current simplifies the reactor control 	<ul style="list-style-type: none"> ◆ <i>Accelerator</i>: Very high reliability required to protect structures from thermal shocks ◆ <i>Beam window and target</i> subjected to unusual stress, corrosion and irradiation conditions ◆ <i>Sub-critical core</i>: Increased power peaking effects due to external neutron source ◆ Compromises between neutron multiplication factor and accelerator power required ◆ Increased overall complexity of the plant ◆ Reduction in net plant electrical efficiency due to power consumption of accelerator
Safety	<ul style="list-style-type: none"> ◆ The reactivity margin to prompt criticality can be increased by an extra margin which does <i>not depend on the delayed neutrons</i> ◆ This enables the <u>safe operation of cores with degraded characteristics</u> as they are typical e.g. for pure MA burners ◆ <i>Excess reactivity can be eliminated</i>, allowing the design of cores with a reduced potential for reactivity-induced accidents 	<ul style="list-style-type: none"> ◆ <u>New types of reactivity and source transients</u> have to be dealt with (external neutron source can vary rapidly and reactivity feedbacks in TRU- and MA-dominated cores are weak)

Note: Issues of particular relevance for the transmutation of TRU and minor actinides (MA) are underlined.

Table 1: Comparison of accelerator-driven subcritical and critical reactor systems [Reproduced from OECD Report on *Accelerator-driven Systems (ADS) and Fast Reactors (FR) in Advanced Nuclear Fuel Cycles*, Table 1.1, page 45]

A superconducting radiofrequency (SCRF) linear accelerator design has been chosen because, compared to linacs using traditional room-temperature (RT) copper technology, SCRF linacs are more power efficient (~50% total system efficiency) and have higher reliability. A comparison of SCRF and RT technologies has been reviewed at Los Alamos by a panel of accelerator experts [Reference: *Accelerator-Driven Test Facility Linac Review*, April 10-12, 2001, Los Alamos National Laboratory report LA-UR-01-2834, May (2001)]. The SCRF linac will employ independently controlled RF modules with redundancy, allowing the less than 300 ms adjustment of RF phases and amplitudes of RF modules to compensate for faults of individual cavities, klystrons, or focusing magnets. Each SCRF cavity will have a larger bore radius that relaxes alignment and steering tolerances, as well as reducing beam loss. Thermal transient has been a major cause of out-of-lock trips in RT linacs. Operating at a stable cryogenic temperature, SCRF linacs have a significantly reduced number of such trips.

The baseline linac technology has been demonstrated. The injector and the RFQ have been fabricated and tested in the Los Alamos Low-Energy Demonstration Accelerator (LEDA) [Reference: Schneider, J.D.; Sheffield, R.; Smith Jr., H. Vernon, *Low-energy demonstration accelerator (LEDA) test results and plans*, Proceedings of the IEEE Particle Accelerator Conference, Jun 18-22 2001 ; Chicago, IL, United States, Vol.5,

p.3296-3298 (2001)]. The elliptical cavities — both the medium-energy cavities and the power couplers, — showed excellent performance in testing for the National Accelerator Production of Tritium (APT) project [Reference: *Executive Summary; Development and performance of Medium-beta Superconducting cavities*, Los Alamos National Laboratory report LA-CP-01-0202, April (2001); *Executive Summary; Development and Performance of Superconducting-Cavity Power Couplers*, Los Alamos National Laboratory report LA-CP-01-461, August (2001)].

Accelerator improvements since 2002 have demonstrated a clear path for the construction of an ADS linac in the near term. However, further work is needed in the design of the subcritical core and the development of adequate separations technology for the very high heat load used fuel from the ADS system.

Though the United States does not have an active program in accelerator driven systems, research has continued in 10 countries overseas, albeit at a much slower pace than the research on fast reactors. As one example of an overseas program, since 1998 SCK•CEN in Mol, Belgium, in partnership with many European research laboratories, has been designing a multipurpose ADS for R&D applications called MYRRHA. An associated R&D support program is being conducted in parallel. MYRRHA aims to serve as a basis for the European experimental ADS, providing protons and neutrons for various R&D applications. It consists of a linear proton accelerator delivering a 600 MeV, 4-mA proton beam to a windowless liquid Pb-Bi spallation target that, in turn, couples to a Pb-Bi-cooled, subcritical fast core of 80-MW thermal power.

Recommendations from the 1996 National Academy of Sciences Report

The National Academy of Sciences 1996 STATS report (cited earlier) is an important document, whose relevance and validity remain as high today as they were in the early 1990s. The overall recommendations from this report have been generally consistent with the 1991 Electric Power Research Institute findings, the observations of the U.S. Utility Industry Advanced Reactor Corporation published in 1995, and later the findings of the 2003 MIT study, *The Future of Nuclear Power*.

The major recommendations from that report are reproduced here:

“The committee found no evidence that applications of advanced [Separations and Transmutation] S&T have sufficient benefit for the U.S. HLW program to delay the development of the first permanent repository for commercial spent fuel. The committee believes that the thermal neutron flux of a LWR and the fast flux of an [Advanced Liquid Metal Reactor] ALMR could be used to transmute the TRU isotopes in spent reactor fuel. Although a significant fraction (90 to 99%) of many of the most troublesome isotopes could be transmuted, this reduction of key isotopes is not complete enough to eliminate all the process streams containing HLW, so the need for a HLW repository is not eliminated. However, the total HLW storage capacity required would be reduced. Transmutation, thus, would have little effect on the need for the first repository.

In view of the above, the committee concluded that the once-through LWR fuel cycle should not be abandoned. Further, this has the advantage of preserving the option to retrieve energy resources from the wastes for an extended period of time.

A reason for supporting continued use of the once-through fuel cycle is that it is more economical under current conditions. Some analysts predict that future demand for uranium—and as a consequence its price—may increase to a point where recycling becomes economically competitive. Should this happen, the choice of once-through fuel cycle would have to be re-examined.

The committee concludes that over the next decade the United States should undertake a sustained but modest and carefully focused research and development program on selected S&T technologies, with emphasis on improved separations processes for separating LWR and transmuter fuels beyond the existing plutonium and uranium extraction (PUREX) process and for fuels containing more actinide elements and selected fission products.”

6.3.3 Proliferation Resistance and Physical Protection

Proliferation is a very complex and broad topic that will not be addressed in any length in this chapter. Proliferation resistance is associated with the acquisition of nuclear weaponry by a non-weapon state. Physical protection relates to defeating the threat of theft of fissile material by a subnational group.

In the past decades, proliferation risks were mostly associated with the back end of the fuel cycle. Enrichment technology was seen as offering a substantial amount of protection because of the size of the gaseous diffusion facilities. Moreover, the amount of uranium required to obtain a significant quantity of highly enriched uranium (HEU) is very large with this kind of technology. However, the introduction of centrifuge technology led to a process that requires much less power to operate and much less uranium inventory. Laser separation technology has the potential to make the technology even less detectable. So, front-end technologies (enrichment) have become a dominant source of concern as well. These technological advances may result in a more neutral view about proliferation risks associated with the back end and the front end of the fuel cycle.

Three main issues can be considered:

- Efficient international safeguards of nuclear facilities applied to non-weapon and weapon states (based on proliferation resistance methodology)
- High-performing physical protection for all nuclear facilities
- Limited material attractiveness

Only the third issue, material attractiveness, is typically explicitly addressed in the context of various fuel cycle schemes. Two nuclear materials are particularly attractive for building nuclear devices: HEU and separated Pu. HEU is no longer physically present in commercial nuclear fuel cycles, so the material attractiveness issue boils down to a plutonium attractiveness issue that includes considerations related to critical mass, spontaneous neutron emission rate, decay heat, and radiological exposure. Works by Pellaud [B. Pellaud, *Proliferation Aspects of Plutonium Recycling*, Journal of Nuclear Materials Management, Vol. XXXI, No. 1 (2002)] and more recently by Kessler [G. Kessler, “*Plutonium Denaturing by Pu-238*,” Nuclear Science and Engineering, 155, 53-

73 (2007)], and Saito [M. Saito, *Development of Methodology for Plutonium Categorization*, Reactor Physics, Vol. 98 (2008)] address potential Pu attractiveness as a function of its isotopic make-up and point to high burn-up as the most practical way to reduce Pu attractiveness for used LWR fuels.

Appendix 6.1: Reprocessing

Reprocessing of used fuel is a means to achieve an end such as recycling, waste conditioning, or both. Today, only the PUREX process has been deployed on a commercial scale at La Hague, France (more than two-thirds of the LWR reprocessed fuel); Sellafield, UK (which has reprocessed a large amount of used Magnox fuel and also some LWR spent fuel); Mayak, Russia, and Rokkasho-Mura, Japan (same design as La Hague, but not in commercial operation as yet). The PUREX process separates used fuel into three different streams: reprocessed uranium, plutonium, and fission products (FP) plus minor actinides (MA) that are incorporated into a glass matrix. Present reprocessing operations result in the release of industrial radioactive discharges into the environment, including hydrogen-3 (tritium), krypton-85, technetium-99, and iodine-129.

Principles of LWR fuel reprocessing by the PUREX process are well known, but industrial implementation and operation are extremely challenging. Many innovative concepts of reprocessing exist, which differ by the sorting sequence of minor actinides (MA) and fission products (FP). A simple compilation that considers only actinides (U, Np, Pu, Am, and Cm) is shown in the table below.

Option	Description	Recycled streams	Waste streams
1	Reference: Once-through		U+Np+Pu+Am+Cm+FP
2	PUREX	U, Pu	Np+Am+Cm+FP
3	Evolutionary PUREX (COEX, NUEX, UREX+2)	U, U+Pu(+Np)	(Np+)Am+Cm+FP
4	Selective MA separation (DIAMEX-SANEX, UREX+3, TOGDA)	U, U+Pu(+Np), Am+Cm	FP
5	Grouped MA separation (GANEX, NEXT, UREX+1)	U, U+Np+Pu+Am+Cm	FP
6	Separation of Cm and Am from each other (UREX+4)	U, U+Pu(+Np), Am	FP, Cm (storage)
7	Pyroprocessing	U, U+Np+Pu+Am+Cm	FP

Table 2: Main advanced reprocessing options.

The first six options are based on aqueous processes, which are well suited for oxide fuels. The last option, pyroprocessing, has been designed to reprocess metal fuel, but it could also apply to oxide fuels by first using a de-oxidation step. There is a significant economy of scale for aqueous reprocessing that leads to large centralized facilities, whereas this is not the case for pyroprocessing facilities that can, as a result, be co-located with reactor facilities.

Reprocessing concepts can be classified by their technological difficulty, defined as their distance from the established PUREX process. Separation of Np together with Pu requires only minor transformations of the current PUREX process, and it could be implemented in current reprocessing plants such as La Hague.

Then, a second process could be added to the PUREX process to separate the remaining actinides and lanthanides (the heaviest fission products) from the other fission products, with a third process to separate the minor actinides (Am+Cm) from the lanthanides. These two additional processes allow selective extraction of MA but complicate significantly the PUREX process.

The next evolution, separation of Cm and Am from each other, is very complex because these two species have very similar chemical properties. However, it would be advantageous to recycle Am (which is a strong decay heat emitter) and not Cm (which is very radioactive and, so, difficult to handle). Research is also being conducted to extract Am directly from the MA+FP stream of PUREX.

Finally, grouped extraction of transuranics relies on aqueous or pyrochemical processes completely different from the PUREX process (especially pyroprocessing, which is the more advanced and less mature technology presented here).

All these processes have a proven high level of performance in the laboratory, but many technical challenges will have to be overcome in order to make them available on an industrial scale. The advantage of the selective extraction pathway, compared to grouped extraction, is that it is a progressive and incremental evolution of PUREX process, not a revolutionary approach. So it limits the industrial risk-taking by using the know-how accumulated over the last decades of LWR reprocessing.

In general, a major finding from work performed over the last couple of decades is the understanding that several required fuel-cycle operations or processes, including separation performance and process losses; fuel development, fabrication, and qualification; and transportation represent engineering and economic challenges that may be more difficult to overcome than those typically associated with the reactors themselves.

Chapter 7

International Hybrid Programs

Walter Sadowski (Chair), Evgeny Avrorin, Englen Azizov, Junghoon Han, Edward Kruglyakov, Boris Kuteev, Yian Lei, Sergey Mirnov, Volodymyr Moiseenko, Roald Sagdeev, Vadim Simonenko, Valentin Smirnov, Alex Stanculescu, Yican Wu

7.1 Introduction

Several countries outside the United States have established or are considering R&D programs related to fusion-fission hybrids. Below is an overview and a set of findings related to these programs.

Note that the contributions below have been prepared primarily by the international participants at the workshop. The material thus represents their assessment of hybrids and has not been critiqued by the Committee of Skeptics nor agreed to or not agreed to by the United States participants.

7.2 Organizational Finding, International Consortium

The South Korean member of the international group of hybrid participants proposes that an international consortium be formed under the auspices of the International Atomic Energy Agency (IAEA) to collaborate on the development of fusion-fission hybrids. The members of the international group from China, Russia, and the United States support this initiative. Other countries will be invited to join. The IAEA participant of the international group supports this initiative and will begin a discussion at IAEA on what will be required to implement this recommendation.

7.3 IAEA Activities and a Possible Role in Fusion-Fission Hybrids

In the wake of the October 2004 Workshop on Subcritical Neutron Production organized by the East-West Center of the University of Maryland, IAEA's Nuclear Energy Department decided to enhance its activities in the field of fusion-fission systems for energy production and transmutation and to cooperate in this area with the Division of Physical and Chemical Sciences within the Department of Nuclear Sciences and Applications. These activities are implemented in the Nuclear Power Technology Development Section.

As a first step, the IAEA convened a consultants' meeting to provide an international forum for follow-up discussions to the University of Maryland workshop. The participants in the consultants' meeting discussed the potential of subcritical systems driven by D-T fusion neutrons for burning or transmuting transuranic elements as well as transmuting long-lived fission products (LLFPs). The discussion included a comparative analysis with accelerator-driven systems.

Participants noted that the development of innovative (fourth generation) fission reactors, development of advanced fuel cycle options, and disposition of existing spent nuclear fuel inventories in various IAEA Member States could significantly benefit from including subcritical systems that are driven by external neutron sources. The consultants reached the following conclusions:

1. Because of their high energy, D-T plasma fusion neutrons are highly effective for burning and transmuting transuranic elements and eliminating LLFPs. In addition, the energy required for their production is relatively low. D-T fusion devices with power in the range of 10 to 50 MW are adequate for driving such subcritical cores. Elements of the current fusion technologies could be used for constructing these D-T fusion neutron sources. Future developments in fusion technology will provide further enhancement of the performance of these systems.
2. Mobile fuels can be advantageous for these subcritical fusion-fission systems, because they eliminate burn-up limits, avoid the need to develop new solid fuel designs, allow low transuranic material inventories without unduly penalizing the transmutation performance, and limit reprocessing operations. When used for spent fuel disposal, mobile fuels avoid the need for pure fissile material streams, strengthening the proliferation resistance of the system.
3. The consultants recommended enhanced coordinated efforts for developing plasma-driven subcritical D-T fusion core designs. The main areas requiring enhanced coordinated research and technology development are nuclear data, forms and preparation of fuel, chemistry control, subcritical core design, and system integration.

Unfortunately, for lack of funding, a planned follow-on workshop in Russia under the aegis of the IAEA could not be realized. However, the agency implemented a four-year (2004–2008) Coordinated Research Project (CRP) on “Studies of Advanced Reactor Technology Options for Effective Utilization and Transmutation of Actinides in Spent Nuclear Fuel.” In this project, participants from 20 institutions in 15 IAEA Member States studied the dynamic behavior of various transmutation systems that included critical reactors, subcritical systems with heavy liquid metal and gas cooling, critical molten-salt systems and hybrid fusion-fission systems (specifically, a tandem mirror transmutation system proposed by the AGH University of Science and Technology in Krakow, Poland, and a benchmark based on a preliminary tokamak fusion-fission hybrid concept called FDS-I proposed by the Institute of Plasma Physics of the Chinese Academy of Sciences).

Looking ahead, the IAEA could play an important role in fostering information exchange and R&D activities in the area of fusion-fission hybrid systems. Using the in-house capabilities in the Department of Nuclear Energy and Department of Nuclear Sciences and Applications, these activities could cover a broad range of research areas, such as nuclear data, plasma physics, fuel and material sciences, and subcritical reactor core physics and design.

Assuming the interest of Member States and availability of resources, one could envisage launching a project that would have the objective of demonstrating actinide transmutation in the laboratory. Concrete tasks aimed at realizing such a project to be implemented under the IAEA aegis are as follows:

1. Identifying existing experimental facilities and devices that could produce 14 MeV neutrons in the near future to permit the first concrete steps toward the realization of a fusion-fission hybrid system on a laboratory scale.
2. Performing studies that would provide a sound scientific basis for a comprehensive comparison of various utilization and/or transmutation technologies, including accelerator-driven systems and D-T plasma fusion devices.
3. Performing design studies for D-T plasma fusion-driven subcritical cores.
4. Performing research and technology development work in areas with the most unresolved issues with respect to D-T plasma fusion-driven subcritical systems, such as nuclear data, forms and preparation of fuel, chemistry control, subcritical core design, and systems integration.

The IAEA implementation mechanisms for these activities would include topical technical meetings and workshops for the first item and CRPs for all the other items.

7.4 The Russian Hybrid Program

For many years, Russian institutions doing research in fusion have been interested in developing fusion-fission concepts to produce neutrons for transmutation of waste, breeding of fuel, and the production of energy and isotopes. An assessment of the role of fusion-fission hybrids in the Russian energy market indicates that fusion-fission systems have a role in the future of nuclear energy in Russia. The major demand that the Russian energy industry places on fusion-fission systems is for production of fuel for light water reactors (LWRs). The role of hybrid systems in solving fuel cycle and waste processing problems is considered valuable as well. Research and technology applications of hybrid systems are intensively discussed by this community. However, opportunities are restricted by comparatively low levels of contemporary basic research and high-tech activities in Russia. International cooperation may improve the situation.

At this time, there are two distinct efforts in Russia to develop a fusion neutron source. One of these is based on the Gas Dynamic Trap (GDT) and the other on the spherical tokamak.

7.4.1 GDT¹

Plans to develop an experimental facility based on the Gas Dynamic Trap for transmutation, molten-salt blanket technology, and testing of materials are underway among several Russian institutes (Budker, Kurchatov, Snezhinsk). These laboratories have expressed an interest in collaborating with the U.S. program and have signed a Memorandum of Understanding to collaborate with the East-West Science Center of the University of Maryland on the development of a neutron source based on the GDT. One of the main thrusts of the R&D work will pertain to the development of steady-state neutral beam sources for use both in mirrors and toroidal concepts. The four institutions will seek funding from the International Science and Technology Center in Moscow for the initial stages of the collaboration.

¹E. Kruglyakov, Budker Institute; V. Smirnov, Kurchatov Institute; E. Avrorin, Snezhinsk

7.4.2 Spherical Tokamak²

Currently, some Russian laboratories are developing a demonstration concept of a hybrid system based on the tokamak. Several options for a demonstration fusion neutron source with either superconducting or non-superconducting magnet systems were analyzed to ensure operation in a steady-state mode. The superconducting neutron source is estimated to cost about \$900M, which has been deemed too expensive for the first demonstration step. Because of the high cost an engineering study has also been carried out for a nonsuperconducting version, whose cost is estimated at \$150M to \$170M. The work was started in 2009. The tokamak neutron source FNS-1, following approval by Rosatom, the Russian nuclear regulatory body, should complete construction by 2013. The TIN-2 pilot plant is projected to complete construction by 2018, with an industrial hybrid system completed by 2025.

²E. Azizov, Trinitiy; Boris Kuteev, Kurchatov Institute

7.4.3 Compact Tokamak as a Neutron Source

The compact tokamak is a more suitable device than a standard tokamak for a fast and relatively inexpensive realization of a fusion neutron source. The concept is based on the following parameters:

1. Aspect ratio in the range between classical and spherical tokamaks
2. Moderate size and elongation
3. $Q \sim 2$
4. $\beta_N \sim 4I_i$ (follows from experiments)
5. $P_{\text{fus}} = 1\text{--}100$ MW
6. Confinement time enhancement factor H of ITER ITB98 (2,y) of $\sim 1.2\text{--}1.4$ (achieved in JET)
7. Deuterium neutral beams with energy 120-140 KeV used for heating and current drive
8. Combined inductive and non-inductive plasma formation and current ramp-up

Heating systems such as neutral beam injection at 120 to 140 KeV, ICRH, ECRH, and LH have sufficient efficiency to maintain a steady state. The means of controlling plasma parameters in the center and the periphery of the plasma are known from existing experiments. Similarly, technological diagnostics and theoretical modeling codes have already been mostly developed as part of the international fusion research program. The codes provide predictions of the evolution of the plasma parameters. Lithium technology and divertor designs have also been developed. Advanced computers and measurement technologies can help control and manage on-line processes in fusion plasma, the first wall, and the divertor.

7.4.4 Work Plan for Creation of a Compact FNS as a Basis for Hybrid Reactors

A three-step process of creating an industrial hybrid system based on the FNS has been adopted in Russia. In some cases these steps may overlap:

First Step

The main objectives of the first demonstration step are design and implementation of a demonstration neutron source and the development of nuclear technology as follows:

- Steady-state tokamak operation supported by powerful steady-state neutral beam injection
- Achievement of neutron flux of 0.2 MW/m^2
- Development and testing of various types of blankets, including molten salt, for fuel production and transmutation
- Testing of tritium breeding systems

The parameters for this FNS are listed in Table 1. Also shown in Figures 1 and 2 are projected profiles of the key physical quantities.

Second Step

The objectives of the second step are development and design of a pilot plant hybrid stationary reactor for breeding and transmutation, including the following:

- Developing effective methods of maintaining and managing steady-state operations with neutron flux of 0.5 MW/m^2
- Selecting the most promising blankets for industrial application to hybrid systems for fuel production and transmutation
- Developing technology (a) to maintain blankets in order to provide high performance and safety analysis and (b) to optimize nuclear processes in order to minimize cost
- Testing the tritium cycle to minimize tritium loss in the pipes

Third Step

The objective of the third step is to develop and put into commercial operation a hybrid reactor based on a tokamak fusion neutron source for fuel production.

Aspect ratio, A	2.5
Major radius, R_0 (m)	1.5
Minor radius a(m)	0.68
Plasma triangularity, δ	0.2
Plasma elongation, κ	1.75
Confinement multiplier, H ITER ITB98(2,y)	1.4
Toroidal magnetic field, B_{to} (T)	3.0
Neutral beam injection power, P_{nbi} (MW)	15
Neutral beam energy, E_{nbi} (KeV)	140
Fuel composition D:T	0.25:0.75
Effective plasma ion charge, Z_{eff}	1.2
Pulse length, seconds	60
Plasma current, I_p (MA)	2.60
Bootstrap current, I_{bs} (MA)	0.78
Current drive, I_{nbi} (MA)	1.83
Safety factor at 95% flux, q_{95}	3.85
Central safety factor q_0	1.51
Internal inductance, l_i (3)	0.72
Average electron density, $\langle n_{20} \rangle$ (m^{-3})	0.5
Greenwald density ratio, $\langle n_e \rangle / n_{gw}$	0.22
Average ion temperature, $\langle T_i \rangle$ (KeV)	4.9
Central ion temperature, $T_i(0)$ (KeV)	11.8
Confinement time, τ_E (s)	0.164
Normalized beta, β_N	2.95
Total D-T fusion neutron power, P_n (MW)	9.77
Beam target interaction, P_{itb} (MW)	8.50
Fusion gain, $Q = P_{fus} / P_{nbi}$	0.65
14 MeV neutron wall load, Γ_n (MW/m^2)	0.2
Fast ion pressure fraction, β_f (%)	45.3

Table 1: Tokamak fusion neutron source with a non-superconducting magnet system

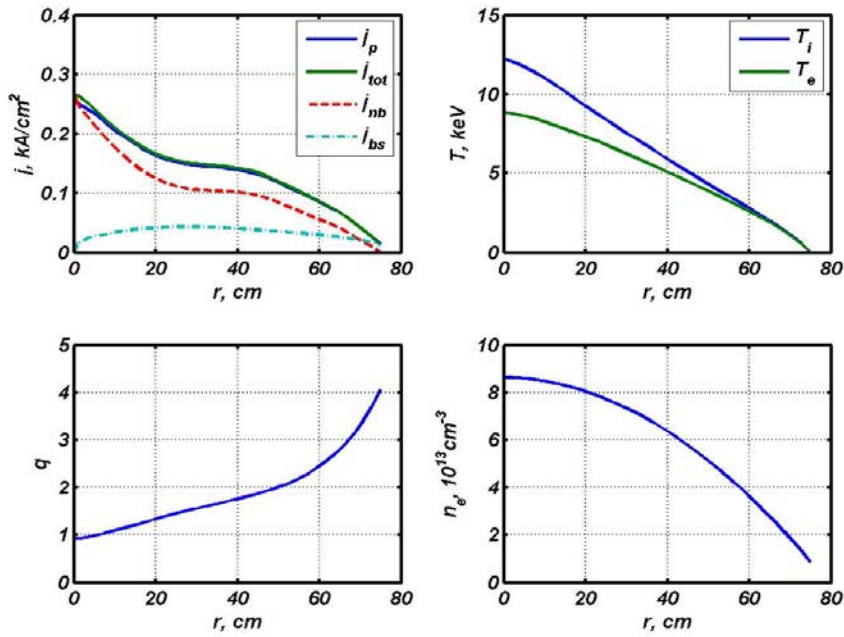

Figure 1. (a) Density current profiles of plasma current j_p , non-inductive current j_{tot} , NBI-driven current j_{nb} , bootstrap current j_{bs} , (b) Ion and electron temperature profiles T_i , T_e , (c) Safety factor profile, (d) Electron density profile n_e during steady-state operation.

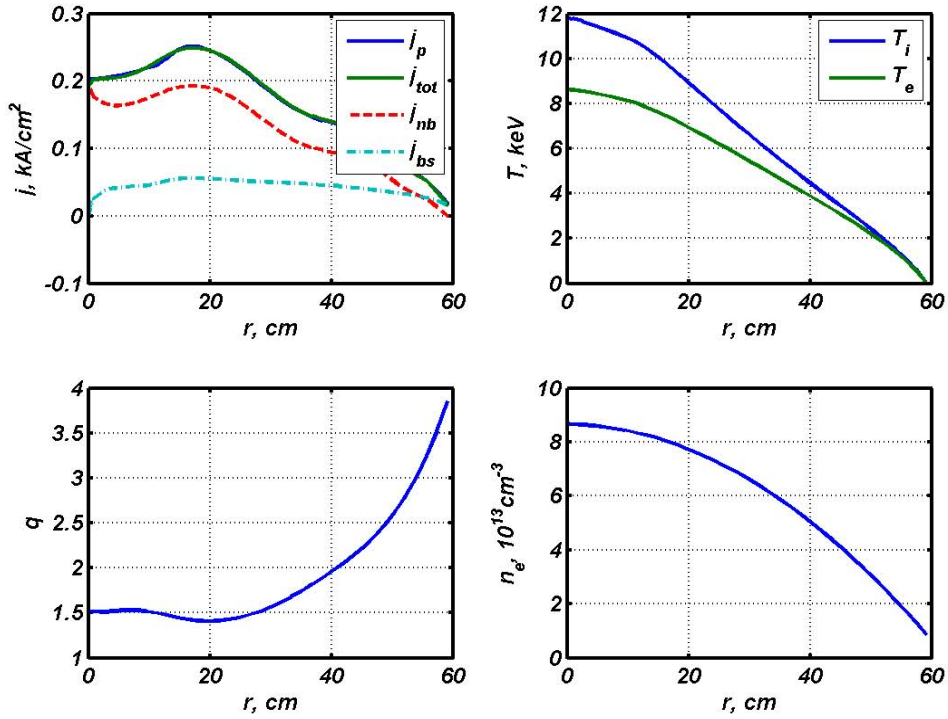

Figure 2. (a) Density profiles of plasma current j_p , non-inductive current j_{tot} , NBI-driven current j_{nb} , bootstrap current j_{bs} , (b) Ion and electron temperature profiles T_i , T_e , (c) Safety factor profile q , (d) Electron density profile n_e during steady-state operation.

References

1. *Kuteev B.V. et al.* // Megawatt Range Fusion Neutron Source for Technology and Research / Third Fusion-Fission Hybrids Workshop, East-West Science Center of the University of Maryland, USA, March 9-11, 2009.
2. *Gryaznevich M.* // Fusion Neutron Source – issues & solutions / Third Fusion-Fission Hybrids Workshop, East-West Science Center of the University of Maryland, USA, March 9-11, 2009.
3. *Ivanov A.A.* // The GDT-based fusion neutron source as a driver of sub-critical nuclear fuel systems / Third Fusion-Fission Hybrids Workshop, East-West Science Center of the University of Maryland, USA, March 9-11, 2009.

For a list of further references see: Powerful Neutron Sources on the Basis of Nuclear Fusion, B.V. Kuteev, P.R. Goncharov, V.Yu. Sergeev, V.I. Khripunov
Bulletin of the Russian Academy of Sciences: Physics, VDK 621.039. In Russian. References are in English.

7.4.5 Technical Findings, Russia

The Russian participants expressed interest in collaborating on the R&D of hybrids for fuel production and transmutation. The specific areas of proposed collaboration are: (1) development and design of steady-state hybrids and (2) research and development of steady-state neutral beams, and materials for the first wall and divertor, blankets, and fuel cycles. The Russian scientists stated that Russia is ready to discuss the organization and framework of a collaboration on a bilateral or multilateral basis.

7.5 The Chinese Fusion-Fission Hybrid Program¹

7.5.1 Characteristics of Fusion-Fission Hybrids

Although recent experiments and associated theoretical studies of fusion energy development have demonstrated the feasibility of fusion power, there is still a long way to go before a pure fusion energy application can be commercially and economically realized. Hybrids represent an application of fusion science and technology that may provide a useful contribution to society on a shorter time scale than pure fusion. Hybrids place lower requirements on fusion plasma technology because of low Q and lower requirements on plasma-facing components because of low neutron wall loading. As an intermediate step between fission energy and fusion energy application, fusion-fission hybrid reactors can be further employed as a neutron source for R&D on the fusion reactor itself.

¹ Yican Wu,^{1,2}Jieqiong Jiang,^{1,2} Yunqing Bai,^{1,2} FDS Team

1. Institute of Plasma Physics, Chinese Academy of Sciences, Hefei, Anhui, 230031, China
2. School of Nuclear Science and Technology, University of Science and Technology of China, Hefei, Anhui, 230027, China

7.5.2 History of Chinese Efforts in Fusion-Fission Hybrid Development

The Institute of Plasma Physics of the Chinese Academy of Sciences, or ASIPP, has produced a conceptual design study of a spherical tokamak as a volumetric neutron source for nuclear waste transmutation. Tight-aspect-ratio tokamaks present a series of problems because of space limitations. A design with an aspect ratio near the lower limit requires an unshielded center conductor post (CCP). The fully exposed CCP will suffer severe neutron and heat damage, requiring periodic replacement. Studies have been carried out to see whether the technical requirements are comparable to those for conventional tokamaks. The studies have shown that the level of neutron damage is comparable to that estimated for the first wall of conventional tokamak reactors. Thus, radiation damage, transmutation effects, and other relevant problems of the CCP need to be studied further if a design with high neutron wall loading is adopted.

In addition to a CCP made of copper alloy, novel concepts of liquid metal CCPs have been studied. The studies included the use of liquid metal as both coolant and electric current carrying medium. The studies showed that liquid metals have potential advantages, such as less transmutation waste produced by regular replacement, almost no electric conductivity change after a long time of operation, easy removal of resistive and nuclear heat because of the use of liquid metal as heat transfer medium, and tolerable neutron structural damage because special materials may be selected for the structure. The studies showed that the service lifetime of such a CCP could be sufficiently long to satisfy economic requirements. Nevertheless, many challenging engineering problems remain.

After 2002, a fusion-driven subcritical system, named FDS-I, was proposed as an intermediate step toward final application of fusion energy. A conceptual design of the FDS-I was presented, which consists of the fusion neutron driver with relatively easily achieved plasma parameters, and the helium-gas/liquid lithium-lead dual-cooled subcritical waste transmutation (DWT) blanket, which is used to transmute long-lived radioactive wastes and generate energy on the basis of a self-sustainable fission and fusion fuel cycle.

In 2003, the IAEA initiated a CRP on “Studies of Advanced Reactor Technology Options for Effective Incineration of Radioactive Waste.” Sixteen institutions from 12 Member States and one international organization participated in this CRP. The reactor systems investigated comprised critical reactors, subcritical accelerator-driven systems with heavy liquid metal and gas cooling, critical molten salt systems, and fusion-fission hybrid systems. The FDS team in ASIPP, as the coordinator of Domain VIII (fusion-fission hybrid system), hosted the second workshop. The steady-state core configurations and transient/accident simulations were performed based on the design parameters of the fusion-driven subcritical system FDS-I.

Along with the past and ongoing efforts to establish fusion as an energy source, there is renewed interest in China in fusion-fission hybrid reactors, especially because of the

progress in the construction and operation of the Experimental Advanced Superconducting Tokamak (EAST) and because of ITER. In the study supported by the Chinese Academy of Science, ASIPP proposed three types of fusion-fission hybrid reactor concepts: the energy multiplier, named FDS-EM with the goal of energy production; the fuel breeder, named FDS-FB with the goal of fissile fuel breeding; and the waste transmuter, named FDS-WT with the goal of transmutation of the long-lived nuclear wastes. The concepts were proposed to reexamine the feasibility, capability, safety, and environmental potential of fission-fusion hybrid systems. Three types of fission blankets have been designed and evaluated in conjunction with three types of plasma cores at a fusion power of 50 MW, 150 MW and 500 MW, respectively. The preliminary analyses covering neutronics, thermal hydraulics, and thermomechanics show that the performance of FDS-EM, FDS-FB, and FDS-WT each meets the technological requirements although each had its own distinguishing features.

The FDS-EM/FDS-FB/FDS-WT concepts present a practical path to the early fusion application for energy production, fissile fuel breeding, and nuclear waste transmutation in a subcritical reactor, which is based on available fusion technologies (at a level extrapolated from the operation of the EAST device) and mature fission reactor technologies such as the pressurized water reactor or helium-cooled high-temperature gas reactors (HTGR).

Neutronics analyses showed that maximum energy multiplication factor M can be of order 130, the maximum fissile fuel breeding ratio BSR can be of order 10, and the maximum waste transmutation ratio TSR can be of order 15, depending on specific designs.

Meanwhile, conceptual design studies of fusion-fission hybrid reactors have been carried out at the Southwestern Institute of Physics (SWIP). These studies included the Tokamak Commercial Breeder (TCB) and the fusion-driven transmutation reactors (FDTR, CFER-ST).

7.5.3 Chinese Experimental Facilities

Within the framework of the hybrid reactor program, China has built and operated four midsized tokamaks, named HT-7, HL-1/1M, HL-2A, and EAST. The HT-7 and HL-2A were built as modifications of the former Russian superconducting tokamak T-7 and the former German normal-conducting tokamak ASDEX with elongated cross-section, while the superconducting tokamak EAST and the normal conducting tokamak HL-1/1M were designed and built by Chinese scientists. EAST is the world's first fully superconducting tokamak with non-circular cross-section and active cooling of plasma-facing components. The experiment is located at ASIPP. Construction was completed in March 2006 and EAST achieved its first plasma on September 2008. Reproducible high-temperature plasma discharges of 60-seconds-plus duration were obtained with lower hybrid current drive on EAST in May 2009. Long-pulse operations (maximum pulse length of 1000 seconds) will be studied in the EAST device with D-D discharges. EAST will also be a test bed for technologies proposed for the ITER project.

Parameters	EAST	ITER	FEB	FDS-ST	FDS-I	FDS-EM/-FB/-WT
Fusion power (MW)	-	500	143	100	150	49
Major radius (m)	1.95	6.2	4	6.2	4	4
Minor radius (m)	0.46	2	1	2	1	1
Aspect ratio	4.2	3.1	4	3.1	4	4
Plasma elongation	1.8	1.85	1.73	1.85	1.78	1.7
Triangularity	0.45	0.33	0.4	0.33	0.4	0.45
Toroidal magnetic field on axis (T)	3.4-4.0	5.3	5.2	5.3	6.1	5.1
Safety factor / q-95	-	3	3	3	3.5	2.03
Plasma current (MA)	1.5	15	5.7	15	6.3	6.1
Average neutron wall load (MW/m ²)	-	0.57	0.43	0.57	0.49	0.17
Average surface heat load (MW/m ²)	0.1-0.2	0.27	0.1	0.27	0.1	0.1
Fusion gain	-	>10	3	>10	3	0.95
Normalized beta, β_N (%)	-	2.5	3.3	2.5	3	3

Table 2: Core parameters of ITER, EAST, FDS-I/-ST AND FDS-EM / -FB / -WT.

In addition to plasma experiments, a series of R&D studies in blanket engineering have been performed in China. These include neutronics integral experiments to test tritium breeding, neutron breeding and multiplication, fuel breeding and neutron shielding, and tritium production experiments using a fission reactor at SWINPC (Southwest Institute of Nuclear Physics and Chemistry). Studies of fusion hybrid-related materials, structural materials, tritium breeding materials, tritium permeation barrier materials, and plasma-facing materials were conducted at ASIPP, CIAE (Chinese Institute of Atomic Energy), SWIP, and IMF (Institute of Modern Physics)/CAS. R&D activities on the structural material China low-activation martensitic steel (CLAM) and related blanket technology are being carried out at ASIPP. R&D activities on CLAM and related technology for liquid Li-Pb blankets for the FDS series designs are being carried out at ASIPP under wide collaboration with other institutes and universities in China and other countries. The combination of these activities include composition design, smelting of the steel, impurity control, property tests, techniques for hot isostatic pressing (HIP), joining and coating, experiments on interaction with plasma, activation analysis, and work on a database for nuclear materials.

To support the various designs and technologies for the Li-Pb breeder blankets, Li-Pb

experimental loops have been designed and constructed in ASIPP to follow the different stages of Li-Pb blanket qualification and for different testing functions. Three thermal convection loops named DRAGON-I/II/III have been built to carry out compatibility experiments and validate the loop technology, and two multifunctional forced convection loops named DRAGON-IV and DRAGON-V are being built to study magnetohydrodynamic effects and perform thermal-hydraulics tests. Three sets of He-Li-Pb dual-coolant auxiliary systems named DRAGON-VI/VII/VIII were designed and will be used for test blanket module testing of EAST, ITER, and Chinese fusion experiment reactor blankets, respectively, in the future.

7.5.4 Future Prospects of Fusion-Fission Hybrids in China

To meet the ever-increasing energy requirements related to improvements in the economy and living standards of the Chinese people, China will need more than 100 nuclear power plants, which will consume large quantities of nuclear fuel and result in the accumulation of a large amount of long-lived nuclear radioactive wastes. Studies of the nuclear fuel cycle have shown that it will not be possible to meet the goals of expanded nuclear energy without the contribution of fusion-fission hybrid energy systems. The reason is the limited known reserves of uranium ore in China. Feasibility studies have shown that the conventional tokamak physics knowledge base and existing technology developed and tested in the ITER R&D program are sufficient to allow for the design and construction of neutron sources for waste transmutation and fuel breeding with modest annual neutron fluence.

References

1. Re-Evaluation of Fusion-Fission Hybrid Reactors for Energy Production, Fuel Breeding and Waste Transmutation. Y. Wu, J. Jiang, M. Wang, Y. Bai, H. Chen, Y. Wang, M. Jin, Y. Wan, FDS Team. Presentation at the 3rd IAEA Technical Meeting on “First Generation of Fusion Power Plants Design and Technology,” July 13-15, 2009, Vienna, Austria.
2. The Fusion-Fission Hybrid Reactor for Energy Production: A Practical Path to Fusion Application. Y. Wu, H. Chen, J. Jiang, S. Liu, Y. Bai, Y. Chen, M. Jin, Y. Liu, M. Wang, Y. Hu, FDS Team. Presentation at the 22nd International Atomic Energy Agency (IAEA) Fusion Energy Conference (FEC-22), Oct. 13-18, 2008, Geneva, Switzerland.
3. Conceptual Design of the Fusion-driven Subcritical System FDS-I. Y. Wu, S. Zheng, X. Zhu, W. Wang, H. Wang, S. Liu, Y. Bai, H. Chen, L. Hu, M. Chen, Q. Huang, D. Huang, S. Zhang, J. Li, D. Chu, J. Jiang, Y. Song, FDS Team. *Fusion Engineering and Design*, 2006, 81: 1305-1311.
4. Neutronics Analysis for the Test Blanket Modules Proposed for EAST and ITER. S. Zheng, M. Chen, J. Li, Q. Zeng, L. Lu, Y. Li, A. Ding, H. Hu, Y. Wu. *Nuclear Fusion*, 2007, 47: 1053-1056.

7.5.5 Technical Findings, China

China has an active program in the development of fusion-fission hybrids. The program includes experimental work on materials and blankets, as well as theoretical and modeling studies on systems and hybrid engineering. China has proposed to the United States to form a U.S.-China design team to collaborate on a project creating a Joint

Fusion Fission Research Facility, which will complement ITER in its fusion mission and will generate data for future hybrid nuclear technologies. China is ready to offer its experimental facilities to serve as a U.S.-China laboratory in the proposed collaboration.

7.6 The South Korean Contribution¹

7.6.1 Fusion Development in South Korea

The South Korean national fusion program started in December 2005 with the development of the Korea Superconducting Tokamak Advanced Research device, or KSTAR. Its mission is to conduct advanced steady-state tokamak operation studies relevant to the fusion power reactor. KSTAR achieved first plasma in 2008.

7.6.2. The South Korean Hybrid Program

The South Korean nuclear industry is 30 years old. A rising issue in the nuclear energy sector is the treatment of spent nuclear fuel (SNF) from 20 nuclear power plants operating in South Korea. Spent nuclear fuel is currently stored at several nuclear power plant sites scattered across South Korea. There is no reprocessing plant for SNF in South Korea, and the storage capacity for SNF will reach its limit by 2016. To address this problem, conceptual development of a fusion-fission hybrid reactor was started in 2007 by a small number of volunteers from the fusion and fission research sectors. They considered two types of hybrid fusion reactors. One was a nuclear fissile fuel breeder reactor and the other was an SNF burner using fusion neutrons. The fissile fuel breeder study was discontinued because of the nuclear situation on the Korean peninsula, and a hybrid burner reactor study of a fusion transmutation reactor (FTR) was chosen and is in progress.

An ad hoc group was organized at the Center for Advance Research in Fusion Reactor Engineering (CARFRE) at Seoul National University in July 2009 for the study of the fusion-fission hybrid burner reactor. The ad hoc group consists of members from the academic sector along with members from industry and the fusion-fission research sector. The ad hoc group considers that an FTR adopting ITER design parameters would be a plausible way to use fusion neutrons for burning spent fuel and producing energy on a relatively short time scale to provide a viable solution for the SNF problem in South Korea. The ad hoc group anticipates close cooperation with other groups or institutes that are actively engaged in fusion-fission hybrid research.

7.6.3 Technical Findings, South Korea

The ad hoc group is looking for close collaboration with other groups or institutes that are actively engaged in fusion-fission research. One purpose would be to exchange views and share ongoing technical development.

References

1. J.H. Han et al., A Conceptual Study for a Feasible Fusion Energy Utilization Plant Fusion Science and Technology / Volume 56 / Number 2 p.930-934.
2. J.H. Yeom et al., System Analysis Study for a Finding of Next Step DEMO Design Parameters Fusion Science and Technology / Volume 56 / Number 2 p.945-948.
3. D.S. Lee et al., A Blanket Study for Feasible Fusion Energy Utilization, submitted to ISFNT-9.

7.7 Technical Findings, Italy

A process is underway to establish collaboration between Russia and Italy involving the Kurchatov Institute and the IGNITOR Project. These efforts concern the construction of near-term ignition experiments based on the IGNITOR concept and the design of neutron sources by producing well-confined high-density plasmas and using high magnetic field technologies developed for the IGNITOR project.

Chapter 8

Report of Skeptics Panel

J. Sheffield (Chair), B. Afeyan, P. Colestock, R. Hanrahan, I. Hutchinson, D. Meade, D. Petti, D. Steiner, C. Baker, M. Mael, K. McCarthy

8.1 Introduction

This report summarizes the results of raising questions about fusion-fission hybrids, articulating the challenges that hybrids face, and identifying their potential disadvantages relative to pure fusion or pure fission systems.

The panel's members are not skeptics about either fission or fusion, or about the importance of benefiting from each other's expertise and research. The panel recognizes the potential for many useful opportunities for synergistic research and development in technology and in the science of nuclear energy production.

The procedure followed by the panel was to first assemble a list of questions about fusion-fission hybrids regarding issues such as technical readiness, nuclear safety, and economic potential and then evaluate those issues in comparison to pure fission systems such as the fission breeder.

Our analysis was focused primarily to the future energy needs of the United States. The panel's list of questions was posted on the workshop's website a few weeks in advance of the meeting. A few responses were sent to us by advocates. At the meeting, the members of the committee in attendance split up among the breakout groups to better understand the views of experts on our questions, to engage in discussions, and to better understand the advocates' responses. Our findings and observations derive mainly from this process. We left the discussion of individual proposals for fusion-fission hybrids to other panels.

8.2 Role of Fusion-Fission Hybrids

Advocates propose the following as motivations for hybrids:

- To support fission energy through breeding fuel and/or burning fission wastes
- To improve the production of electricity from fusion by adding a fission cycle
- To reduce the requirements on the fusion system, and thereby accelerate the deployment of fusion energy before pure fusion systems become economically viable on their own

To assess the value of these goals, we consider first the perceived advantages and disadvantages of pure fusion energy.

Advantages of pure fusion

- It uses a practically inexhaustible fuel resource. Initially using deuterium (D) and lithium, it would first be limited by lithium resources, but those would nevertheless last at least many thousands of years. Ultimately, the fuel would be unlimited once the D-D cycle is realized.
- Wastes are much more easily managed. Activation products from fusion should be much less problematic than actinides and long-lived fission products.
- From a safety point of view, fusion has no criticality risks. A power plant should contain minimal (100–1000 g) fuel or radioactive inventory at any instant. Afterheat would be minimal.
- In regard to proliferation, while fusion plants would have tritium, they would have no fissile fuel cycle, and no business having any actinides on site, so inspections would be technically straightforward.

Disadvantages of pure fusion

Fusion's disadvantages are also real and constitute its biggest challenges:

- Net energy production has not yet been demonstrated in a controlled manner. In contrast, the Chicago Pile came early on in the development of fission energy.
- Challenges in materials and components that arise from surface/volume fusion-specific issues include first-wall heat handling, thermo-mechanical loads owing to the plasma, and 14 MeV neutron damage.
- Specific problems are associated with the very large scale of fusion devices, a result of the physics requirements and the characteristics of 14 MeV neutrons, which make it difficult to realize small-scale, energy-producing prototypes.
- Its development requires complex systems engineering, as compared to alternative energy sources.

Advocates argue that fusion-fission hybrids may partially alleviate these challenges, because they have lower demands on the fusion subsystem. However, these reduced technical requirements would be achieved at the cost of eliminating essentially all the advantages of pure fusion energy.

- Although hybrids might help make use of fertile material, they would have the same resource limitations as fission reactors.
- They would have fission wastes, not simply the minimal fusion activation.
- In most options they would have all the safety concerns of fission.
- Hybrids have substantial quantities of fissile materials and tritium and hence raise major proliferation concerns.

As pointed out by John Holdren in “Fusion-Fission Hybrids: Environmental Aspects and Their Role in Hybrid Rationale,” *J. Fusion Energy* 1, 197, 1981:

“... if society rejects pure fission on environmental grounds (again including weapons linkages and related political issues under this heading), then it will surely reject fusion-

fission hybrids as well. The environmental differences between a pure fission system and one that contains fusion-fission hybrids are simply not big enough nor even all in the hybrid's favor. (Pure fusion, by contrast, has at least the potential to be so superior to fission environmentally that the differences would be essentially qualitative. Thus it is conceivable that pure fission could be rejected and pure fusion accepted.)”

8.3 Critique of Proposed Hybrid Advantages over Pure Fission

The principal issue is whether using fusion-fission hybrids to burn actinides and produce fuel offers real advantages over a pure fission system, given that fission breeder reactors are a real technology. Breeding, burning, and energy production are all intertwined. Thus the recent emphasis in fusion-fission hybrid designs on burning actinides just introduces nuances beyond the many historic hybrid studies, rather than introducing totally new issues. From discussions in the fuel cycle breakout sessions it was clear that a principal need is to compare the various fuel cycles (pure fission and fusion-fission hybrid) on a common basis to establish if there are any real benefits of the fusion-fission hybrid.

At the meeting, answers from advocates were equivocal on the attractiveness of the transuranic burning mission. It depended on the nuclear energy scenario. If a closeout of nuclear energy is envisaged, burning is the only relevant mission. If sustained use of nuclear energy is planned, then it is more important to breed fissile fuel and produce energy.

Further, fuel is only a small part of current nuclear fission costs, including the cost of ultimate disposal. The amount of nuclear fuel and waste is small in volume, owing to the high energy density of fission, and there is a range of technically acceptable ultimate disposal approaches. Inherent costs of disposal are a small fraction of the cost of electricity. Thus, although actinide burning is a laudable ideal, it is not inherently economically valuable.

Costs, and hence value, can be greatly enhanced relative to their inherent levels by political action and by public opinion. But it appears that for the very long term there will be a strong tendency toward intrinsic cost-effectiveness. The immediate “need” for hybrids for actinide burning appears not to be coming from the fission community, but rather is driven by hybrid advocacy.

The panel noted a difference in views of the benefits of subcriticality. The hybrid advocates claim that it was an important advantage for fusion drivers that use transuranic fuels to obtain waste burning by transmutation. Most fission experts at the meeting said that the benefits were less than claimed by the advocates, noting also that driven systems bring their own problems. They also said that much the same burning could be obtained if desired by pure fission/recycle, and that criticality control, while obviously important, did not dominate fission reactor safety.

Observations on Hybrid Challenges

We heard that:

- Much of the fusion system will be the same, requiring common R&D.
- The fission-fusion interface adds complexity and new risks, and will require R&D outside that required for either fusion or fission separately.
- The fuel cycle and blanket will need to be developed.
- There are increased and new safety, proliferation, and licensing problems related to the combination of fission and fusion in one machine that would have to be solved.
- Because the area has received only limited attention, claims by advocates that hybrids significantly accelerate fusion development were repeatedly brought into question. The costs and time scale remain uncertain and would require more study to validate the claims.

Comments on Proposed Hybrid Advantages over Pure Fusion

Time scale

It has often been said that the hybrid offers a nearer-term application of fusion. Many dispute this claim because the development of fusion technology and materials is likely to be the pacing item. Hybrid technology is not qualitatively easier than pure fusion. While hybrids may in some concepts make the fusion driver's role easier, the integration of the fission blanket into the facility requires additional technologies, which need to be proven, and additional complexity that must be addressed. Hybrids also open up proliferation routes that should be addressed before proceeding.

At the workshop we learned that in Europe and the United States the needs (if any) for hybrids for burning/breeding is long term, not short term. However, the presentations from Chinese, South Korean, and Russian researchers emphasized their near-term needs for these capabilities.

Reduced requirements on fusion performance

Some fusion-fission hybrids offer the possibility of reducing the requirements on Q , confinement, pressure, and 14 MeV wall loading. Lower availability compared to pure fusion electricity production may also be possible — subject to economic considerations. These features translate into reductions in the physics and technology requirements for fusion neutron production. However, many of the technologies would still require the development and qualification of fusion reactor subsystems similar to those found in pure fusion systems. These potential gains need better quantification in light of the requirement for development of additional technologies and their integration complexity. Among questions that should be answered are:

How much overlap is there between the R&D required for hybrids and that for pure fusion and/or pure fission?

- How significant are the actual advantages in neutron wall loading and materials feasibility, once fission neutrons and other constraints are accounted for?
- How attractive are fusion hybrids relative to other neutron options such as pure fission systems (accelerators)?
- How valuable is the fact that hybrids might be able to accept a lower availability?

8.4 Fusion Energy: A Scientific and Technical Grand Challenge

The development of a commercial fusion energy system is intellectually and technically extremely difficult, but would have enormous transformational benefits if successful. In our view, fusion-fission hybrids are probably equally challenging, but they cannot transform the prospects and characteristics of nuclear energy. That is why hybrids are not a “Grand Challenge” like pure fusion.

Hybrids might improve fission’s ability to burn actinides, but there is not a consensus among the experts. Hybrids might improve fission’s ability to produce fissile fuel as a complement to fast breeders, but there was no consensus that the United States needs an additional source of fissile fuel in the near term (the next 50 years). The cost of pursuing the hybrid path is at the expense of losing all of fusion's major attractive features, while retaining (almost) all of its complexity and uncertainty and creating new proliferation concerns.

The fusion technology R&D needed for hybrids appears to be little different from that for pure fusion, and in some cases requires additional breakthrough R&D in fission technology.

In our view, science and technology priorities for fusion ought to be directed to the Grand Challenge — pure fusion. Hybrids are not thereby ruled out, but they do not appear to warrant influencing near-term nuclear energy research priorities in the United States. This situation may be different for other countries that have different energy and waste management scenarios.

8.5 Findings (in approximate priority order)

- Proposed hybrid fuel cycles, including ultra-deep burn, have to be analyzed and compared to pure fission approaches using consistent assumptions.
- Hybrid blankets involve challenges beyond those that exist for pure fusion blankets or the analogous fission reactor cores.
- Safety and proliferation issues for fusion-fission hybrids appear significantly more difficult than those for pure fission or fusion.
- Hybrids have significant quantities of fissile materials and tritium and hence raise major proliferation concerns.

8.6 Observations (in no particular order)

- Fission experts did not express an immediate need for new fuel cycles.
- A critical issue for technical readiness of the fusion subsystem is high-average-power demonstration of safe operation at an acceptable availability.
- The extent of the reduction of technical challenges for fusion by adopting hybrid configuration needs further clarification in terms of the overall development time for the hybrid compared to that for pure fusion.
- The time scale of need for, or interest in, hybrids does not appear to be well defined and may be country-dependent.
- While there may be advantages to fission-fusion hybrids, the argument that they will accelerate fusion deployment was unconvincing to the panel and needs more study.
 - A research direction driven uniquely by hybrids does not yet appear to have been defined.
 - Proliferation issues regarding hybrids are not entirely covered by those pertaining to fission and fusion systems alone.

Chapter 9

High-Level Findings and Research Needs

Entire Workshop

In developing the findings, the members of the workshop found it useful to first describe the current status of nuclear power production in the United States to serve as a point of reference for comparing the potential contributions of fusion-fission hybrids. The current status as viewed by the workshop participants can be summarized as follows.

There are three main components to the production of nuclear power: fuel supply, electricity production, and waste management. Currently electricity is produced by light water reactors (LWRs), fuel is supplied from mined natural uranium, and waste management is provided by on-site storage. The strategies for fuel supply and waste management are not sustainable, in our view, beyond about 50 to 100 years.

The fission community has been well aware of sustainability problems for many years. Its adherents have proposed solutions involving fast breeders for fuel supply and fast burners for waste management. These technologies could be available on a time scale much shorter than 50 years.

With this background, the high-level findings of the workshop are as follows:

9.1 High-Level Findings

1. Ideas put forth by hybrid proponents: The idea of the fusion-fission hybrid is many decades old. Several ideas, both new and revisited, have been investigated by hybrid proponents. These ideas appear to have attractive features, but they require various levels of advances in plasma science and fusion and nuclear technology.

a. A waste transmuter based on the leading magnetic fusion and fast burner reactor technologies: One tokamak-based proposal combines ITER physics and technology (the leading magnetic fusion technology) with sodium-cooled fast burner reactor technology, plus the associated fuel reprocessing/refabrication technologies (the leading related burner reactor technologies). By building on the most advanced systems in both fusion and fission, this hybrid concept would require the least amount of advanced technology development. ITER is designed to achieve a duty factor of 25% for burn periods greater than 10 minutes, and to operate continuously for periods of 12 consecutive days. However, it is designed to operate only about 4% of the cumulative time over its 14 year D-T operation period. This performance level is well below the 50 to 75% required availability for a hybrid system, so significant fusion technology reliability advances would still be required (as for any fusion concept), and the technology to integrate the two systems (such as dealing with a liquid metal in a magnetic field) would need to be developed. A reprocessing fuel cycle was proposed in which the actinides from LWR spent fuel were burned to greater than 90% in the hybrid.

b. *A waste transmuter with a removable fusion core:* This is a spherical tokamak-based concept that employs a compact replaceable fusion core that can be extracted as a single unit from the fission reactor. The goal is to minimize the electromagnetic and mechanical coupling between the fusion and fission systems. Maintenance and repairs would be simplified by periodically removing the fusion core to a remote bay and replacing it with another in the fission reactor. Also, to minimize magnetohydrodynamic (MHD) problems, the fission blanket is located outside the toroidal magnetic field coils. The fuel cycle of interest, which could be used by other hybrid concepts as well, uses a fusion-enhanced version of the two-tier process. Actinides are first reprocessed from spent fuel, then 75% burned in an intermediate-stage LWR using inert matrix fuel (IMF) and finally burned in a hybrid, thereby providing a high support ratio. However, a new IMF would need to be developed, and a full systems analysis is required to assess the overall economics, including the contributions of the intermediate-stage IMF LWRs. Probably one additional physics development step is required before an ITER-equivalent neutron source prototype could be built.

c. *Once-through, burn-and-bury energy producers:* A very deep-burn fuel cycle based on laser fusion has been proposed, in which nuclear fuel is almost completely burned. The initial fuel does not require enrichment. Perhaps even more important, the deep burn has the attractive feature that, if it is successful, no reprocessing would be required. However, a very deep-burn fuel form needs to be developed, and almost the full capabilities of pure fusion systems would be required. Also, high-power, high rep-rate lasers need to be developed to produce high average power and the first wall would need to endure the same fusion neutron fluence as a pure fusion system.

d. *Efficient LWR fuel breeders:* These breeders are concepts in which fissile fuel is produced in a flowing liquid blanket. The fissile fuel is removed on line in order to suppress its subsequent fission in the hybrid system. An efficient fuel breeder for LWRs has the advantage of enabling a long-term sustainable fleet of LWRs requiring relatively few hybrids for fuel production. However, in addition to fusion technology developments, this concept requires the development of continuously flowing fuel systems. The use of hybrids to produce fissile fuel is applicable to both magnetic fusion energy (MFE) and inertial fusion energy (IFE) systems. It was studied in great detail during the 1980s by MFE mirror advocates. The mirror configuration may need to be revisited because of recent progress in plasma performance which was obtained in the international fusion program.

3. Repositories: Any waste management strategy using either pure fission technology or fusion-fission hybrid technology will still require a long-term geological repository for the final remaining long-lived waste.

4. A political problem: Although technologically deployable long-term solutions for fuel and waste management may not be needed for half a century, there is a short-

term political problem facing the nation. With work on Yucca Mountain halted, there is no perceived progress on addressing the waste management problem on any time scale.

5. Economic comparison of pure fission vs. fusion-fission hybrid solutions: There was general consensus that a hybrid capable of producing a certain amount of electric power would be noticeably more expensive than an LWR producing the same amount of power. Economic comparisons thus have to be made on an overall systems basis. For example, we must ask what is the overall cost of a group of LWRs plus necessary hybrids versus a combination of LWRs plus perhaps a larger number of fast reactors, with each system producing the same amount of power and reducing the waste to the same level.

6. An intermediate step to pure fusion electricity: Advocates suggest that a fusion-fission hybrid can be developed on a shorter time scale than for pure fusion electricity because the required plasma physics and some technology requirements are substantially reduced. Some of the panels and also the skeptics argued that some technology may be more complicated in a hybrid because of the integration of fusion and fission technologies. Perhaps more important, the pace of development will be dominated by engineering and technology and not by plasma physics. The skeptics plus some panel members believe that the time scales for development will be comparable for both.

7. The international fusion-fission hybrid program: Some of the experts at the workshop expressed concerns about the slow pace of development of fusion-fission hybrids in the U.S. program. However, such concerns were not shared by our international colleagues. Indeed, several countries, including the Russian Federation, South Korea, and China, are considering the option to develop neutron sources as a first step toward building hybrids.

8. Proliferation: Hybrids produce significant quantities of fissile materials, generally not retained in individually accountable fuel rods, and hence raise significant proliferation concerns.

9.2 High-Level Research Needs

1. Comparison between fission-based and hybrid solutions: The first step that needs to be carried out is a side-by-side systems analysis comparison of proposed pure fission and fusion-fission hybrid solutions to the problems of waste management, fuel supply, and electricity production. The basic ground rules are that comparable assumptions (regarding material properties, fuel forms, and so forth) must be used for each design.

2. Fusion engineering and technology: There appeared to be widespread consensus that neither pure fusion nor fusion-fission hybrids could be developed, even in 50 years, unless the fusion engineering and technology programs were restarted in the

DOE Office of Fusion Energy Sciences Program (OFES). Of particular concern was the need for an expanded blanket and materials research program. Without strong fusion engineering and technology programs, the United States will continue to be unable to have a defined timetable for a fusion power plant and thus will fall further and further behind our international colleagues — they will be the leaders and we the followers.

Chapter 10

Technical Findings and Research Needs

10.1 Technical Findings

In addition to the high-level findings, the workshop participants developed a set of more detailed technical findings related to various aspects of fusion-fission hybrids. These findings are described below.

10.1.1 Findings from the Fusion-Fission Fuel Cycles for Waste Disposal Subcommittee (Chapter 3) (Bob Hill, Yousry Gohar, Rob Goldston, Swadesh Mahajan, Stuart Maloy, Ralph Moir, Kemal Pasamehmetoglu, Jim Tulenko)

1. Comparison of pure fission and hybrid fuel cycle issues: There is much overlap between the family of fission fuel cycle strategies and proposed hybrid fuel cycles. This overlap includes both the waste management and resource use missions. Thus, at the highest level the fuel cycle challenges are similar for pure fission and hybrids. Specifically, there are a common set of R&D needs including (1) high burn-up fuels, (2) radiation damage-tolerant materials, (3) low-loss recycle (separations and fab) technology, (4) efficient energy conversion for recycle fuel applications, and (5) superior waste forms for residual wastes.

2. Neutron-balance benefits of hybrids: The hybrid device has certain neutron-balance benefits compared to fast reactors. There is potentially more control over the system neutron balance because the hybrid has an independent neutron source provided by the fusion core. Also, the fusion neutrons initially have a higher energy (14.1 MeV) compared to fission neutrons (2 MeV). This difference suggests that there may be better multiplication from high-energy neutrons. The favorable neutron balance could be a beneficial feature for certain fuel cycle applications, including transmutation of long-lived fission products and fuel generation from fertile materials (such as start-up of the thorium cycle and production of fuel for light water reactors [LWRs] and fast reactors).

3. Proliferation and safeguards: Hybrid and fission fuel cycles face the same general proliferation concerns and issues: creation and use of fissile materials and application of fuel recycle technology. The distinctions for the specific technology options are not obvious (such as limited recycle, on-line or periodic separations, and so on). More detailed investigation would be required to compare the fuel cycle strategies.

10.1.2 Findings from the Proposed Hybrid Reactors Subcommittee (Chapter 4) (Harold Weitzner, Benjamin Cipiti, Jeff Harris, Mike Kotschenreuther, Wally Manheimer, Wayne Meier, George Miley, Martin Peng, Dmitri Ryutov, John Sarff, Bill Stacey, John Slough, Erik Storm, Glen Wurden, Leonid Zakharov)

1. The status of fusion drivers: Fusion drivers for the fusion-fission hybrid and/or pure fusion missions would be credibly developable through the pilot status during the time in which they may be needed and relevant. In magnetic fusion the tokamak and some of its variants, as well as mirror machines, fall in this category. Inertial confinement offers a number of possible different configurations, which will allow either indirect or direct-drive implosion systems.

2. International collaboration: Particularly in magnetic confinement, international collaboration is an essential element of any development strategy, given the limitations of the U.S. program. One specific suggestion discussed at the workshop involves a possible collaboration between the United States and China. The project envisions a fusion-fission research facility built in China, which would complement the ITER mission by focusing on technologies aimed at the development of fusion-fission hybrids.

10.1.3 Findings from the Hybrid Blanket Subcommittee (Chapter 5) (N. B. Morley, M. Abdou, J. Blanchard, J. Gehin, P. Peterson D. Petti)

1. Developing hybrids: Developing hybrids will require substantially the same types of research and development as needed for pure-fusion plasma-facing components, blankets, and nuclear technology materials and components, as well as that needed for new fission fuels and safety. This is a key area for further evaluation, as the ultimate feasibility and attractiveness of the hybrid will rest largely on these technological systems.

2. Potential benefits of hybrid blankets vs. pure-fusion blankets: The development of hybrids can have economic, reliability, cost/time, and risk benefits when compared to pure-fusion energy blanket systems, stemming from the following potential avenues: (a) energy and neutron multiplication behind the first wall, leading to reduced fusion neutron wall load and surface heat load that may ease fast neutron damage or thermomechanical load, or (b) driver selection and operation with a reduced number or intensity of both disruptions and edge localized modes (ELMs), plus the ease of maintenance and replacement of components. However, not all hybrid concepts attempt to realize these potential benefits, instead pursuing other goals.

3. Technological readiness of hybrid blankets: The technology readiness for the fission blankets in the fusion-fission hybrid is behind that of the fission analogs. Qualification of these blankets will take at least 20 to 25 years based on the fission experience, and would require similar integrated test facilities as needed in both pure fusion and fission development. Whether the development time scale is longer or more rapid than for pure fusion cannot be firmly concluded without further extensive analysis. There is concern that the development aspects of the hybrid blanket related to reliability, maintainability, safety, and high burn-up fuels may be significant.

4. Safety of fusion-fission hybrids: The burden of proof associated with the safety case for the fusion-fission hybrid will be much greater than for pure fusion, given the hazards associated with the fission blanket, the more complex and unconventional approaches required to mitigate loss-of-coolant accidents (LOCA), the unique energy sources associated with fusion, and the overall complexity of the system.

5. Fusion-fission hybrid blanket neutronics: The ability to simultaneously meet tritium breeding requirements and fission fuel breeding or transmutation goals must be based on neutronics analysis, including more complete design of the structure, coolants, penetrations, plasma fueling/control systems, plus other components, and including time variations coming from fuel burn-up and reduced reactivity. Attention should be paid to the shorter neutron mean free path in hybrid blankets and the implications for blanket thickness, power density, and neutron leakage.

6. Fission blankets outside the magnets: The strategy of completely removing the fission blanket to a region outside the toroidal field (TF) coils of the fusion device is a paradigm shift from fusion power plant designs that has several potential advantages. However, detailed implications for access to plasma maintenance systems, the ability to meet tritium production requirements, and the economics and waste disposal must be fully analyzed to confirm its viability.

7. Fission blankets inside the magnets: The attempt to put near-term fixed fuels from existing fission fast reactor designs inside the fusion vacuum vessel adjacent to the plasma appears very difficult from the following perspectives: fuel loading, shuffling, unloading; LOCA response; and fuel or coolant interactions with magnetic fields and disruptions. Mobile fuels may offer benefits for overcoming geometric access restrictions, and fuel damage due to fusion conditions, but concerns must be addressed regarding licensing and IAEA safeguards in the current regulatory environment. Licensing will be a challenge in any case, as all hybrid variants represent new nuclear technologies.

10.1.4 Findings from the Alternative Approach Subcommittee (Chapter 6) (A. Machiels, J. Kessler, G. Rochau, R. Sheffield, P.N. Swift)

1. Geologic repositories: There was general consensus that all nuclear fuel cycle options will ultimately require geologic disposal of waste. That is, it is not physically possible to completely burn all long-lived actinides and fission byproducts so that geologic disposal, such as in a mined repository, would not be needed. Specific findings are as follows.

- a. Separation and transmutation of transuranic elements have little to no *practical* impact on long-term doses to the public from the repository.
- b. Separation and transmutation of Am-241 would be effective in increasing the repository capacity, assuming that the main heat-generating fission products (Sr-90 and Cs-137 and their daughters) are allowed to decay for 60 to 90 years.

- c. It is worthwhile to keep in mind the conclusion from the 1996 National Academy of Sciences report on Separations and Transmutation that there is “*no evidence that applications of advanced S&T have sufficient benefit for the U.S. HLW program to delay the development of the first repository for commercial spent fuel*” (Finding from 1996 National Academy of Sciences Report)

2. The role of advanced fuel cycles: Advanced fuel cycles will eventually be required to support a much stronger role for nuclear power in providing carbon-free electricity generation.

- a. Natural resources contain abundant supplies of fertile materials (U-238 and Th-232), and fast neutron systems will be required to fully use these resources.
- b. Large R&D programs on sodium-cooled fast-spectrum breeder reactors are being pursued in China, France, India, Japan, and the Russian Federation.

3. Accelerator-driven systems (ADSs): Limited efforts on ADSs are being pursued in Asia and in Europe. The main reasons for interest in ADSs are the fast-neutron spectrum for burning minor actinides, subcritical operation, and the status of the required accelerator technology that has, for the most part, been demonstrated. Subcritical operation has the advantage of driving systems with fuel blends that could make critical systems less stable (Pu and minor actinide without uranium or thorium) and compensating for large uncertainties or burn-up reactivity swings. However, the subcritical mode of operation cannot avoid decay-heat-driven accidents, and specific safety analyses will have to be performed to account for subcritical system features.

10.1.5 Findings from the International Hybrid Program Subcommittee (Chapter 7) (W. Sadowski, Valentin Smirnov, Evgeny Avrorin, Englen Azizov, Alex Stanculescu, Edward Kruglyakov, Yican Wu, Vadim Simonenko, Sergey Mirnov, Yian Lei, Boris Kuteev, Junghoon Han, Volodymyr Moiseenko, B. Coppi)

Several countries outside the United States have established or are considering R&D programs related to fusion-fission hybrids. Below are the findings related to these programs.

1. The Russian program: The Russians have a longstanding interest in hybrids, although at this point in time no specific fusion driver has been selected. The program involves a significant amount of experimental plasma research and engineering assessments related to mirror-based neutron sources for material and subcomponent testing. Among several Russian institutes (Budker, Kurchatov, Snezhinsk), plans are underway to develop a mirror-based facility for transmutation, to develop molten-salt blanket technology, and to conduct testing of materials. In the area of toroidal concepts, a spherical tokamak approach seems to be the most promising as the cheapest and simplest option for a neutron source and a fusion-fission hybrid. Development of concepts for pure fusion neutron sources, whether multipurpose or

specialized for basic research and nanotechnology, transmutation, and fuel production, would represent the next stage of development. The Russian visitors expressed an interest in collaboration on the R&D of hybrids for fuel production and transmutation. The specific areas of collaboration would be: (1) development and design of steady-state hybrids. (2) R&D for steady-state neutral beams and (3) R&D for materials for the first wall, divertor, blankets, and fuel cycle. The Russian scientists stated that Russia is ready to discuss the organization and framework of collaboration in the field of tokamak hybrids on a bilateral or multilateral basis. The Novosibirsk group has expressed a strong interest in continuing collaboration with U.S. institutions in the area of mirror-based neutron sources.

2. The Chinese program: China has an active program in the development of fusion-fission hybrids. The program includes experimental work on materials and blankets, as well as theoretical and modeling studies on systems and hybrid engineering. China is ready to offer its experimental facilities as a U.S.-China laboratory for the development of hybrids. China has proposed to the United States to form a U.S.-China design team to collaborate on a project of Joint Fusion Fission Research Facility, which will complement ITER in its fusion mission and will generate data for future hybrid nuclear technologies.

3. The South Korean program: An ad hoc group was organized at CARFRE in Seoul National University in July 2009. The group was formed in consultation with several members of the South Korea nuclear power sector. It consists of members from the academic sector plus members from industry and the fusion-fission research sector. The ad hoc group renamed the fusion-fission hybrid reactor the “fusion transmutation reactor” (FTR) and discussed baseline parameters for an FTR. The FTR has a dual role of symbiotic green energy multiplication and spent nuclear fuel waste management. The ad hoc group believes that the FTR, adopting ITER design parameters, would be a plausible way to utilize fast fusion neutrons on a relatively short time scale and could be a viable option for the solution of once-through spent nuclear fuel in South Korea. The South Korean visitors stated that the ad hoc group is looking for close collaboration with other groups or institutes that are actively engaged in fusion-fission research. They would like to establish close communications with international fusion-fission research efforts for the exchange of views and for ongoing technical development.

4. An Italian suggestion: A process is underway to establish collaboration between Russia and Italy involving the Kurchatov Institute and the IGNITOR Project. These efforts concern the construction of near-term ignition experiments based on the IGNITOR concept and the design of neutron sources by producing well-confined high density plasmas and using high magnetic field technologies developed for the IGNITOR project.

5. A South Korean suggestion: The South Korean member of the international subcommittee proposes that an international consortium be formed under the auspices of International Atomic Energy Agency (IAEA) to collaborate on the development of

fusion-fission hybrids. The members of the subcommittee from China, Russia, and the United States support this initiative. Other countries will be eligible to join. To implement this initiative, members of the international subcommittee will ask that their country's representative in the Technical Working Group on Fast Reactors (TWG-FR) request IAEA's participation in constructing a framework to support international collaborative activities in the development of fusion neutron sources and fusion-fission hybrids. The IAEA representative in the international subcommittee supports this initiative and will initiate a discussion on what will be required to implement this recommendation.

10.1.6 Findings from the Skeptics Panel Subcommittee (Chapter 8)

(J. Sheffield, B. Afeyan, P. Colestock, R. Hanrahan, I. Hutchinson, D. Meade, D. Petti, D. Steiner, C. Baker, M. Mael, K. McCarthy [absent from meeting])

Findings (in approximate priority order):

1. Proposed hybrid fuel cycles, including ultra-deep burn, have to be analyzed and compared to pure fission approaches using consistent assumptions
2. Hybrid blankets involve challenges beyond those that exist for pure fusion blankets or the analogous fission reactor cores.
3. Safety and proliferation issues for fission-fusion hybrids appear significantly more difficult than those for pure fission or fusion.
4. Hybrids have significant quantities of fissile materials and tritium and hence raise major proliferation concerns.

Observations (in no particular order):

1. Fission experts did not express an immediate need for new fuel cycles.
2. A critical issue of technical readiness of the fusion subsystem is high-average-power demonstration of safe operation at an acceptable availability.
3. The extent of the reduction of technical challenges for fusion by adopting hybrid configuration needs further clarification in terms of the overall development time for the hybrid compared to that for pure fusion.
4. The time scale of need for, or interest in, hybrids does not appear to be well defined and may be country-dependent.
5. While there may be advantages to fission-fusion hybrids, the argument that they will accelerate fusion deployment was unconvincing to the panel and needs more study.
 - a. A research direction driven uniquely by hybrids appears does not yet appear to have been defined.
 - b. Proliferation issues regarding hybrids are not covered by those pertaining to fission and fusion systems alone.

10.2 Technical Research Needs

10.2.1 General Research Needs

1. Comparison of hybrids with pure fission and accelerator-driven systems:

Here a more technical description is given of the high-level research need related to making fair comparisons between hybrids and non-hybrid solutions to nuclear sustainability. Consider different overall nuclear power systems, including: (a) LWR conventional and burner reactors; (b) critical burner, breeder, and self-sustained reactors; (c) fusion-fission hybrid burner, breeder, and self-sustaining reactors; (d) accelerator-driven burner, breeder, and self-sustaining reactors; (e) the fuel reprocessing and refabrication facilities required for a through d; and (f) the waste disposal systems required for a through e. Comparison analysis should be performed for various assumptions about the continuation and expansion of nuclear power and for various strategies for implementing an expansion of nuclear power. These studies should use *comparable technical assumptions* and should consider costs, impact on waste streams (heat, dose, radiotoxicity, proliferation, etc.), and ability to meet nuclear power expansion objectives.

2. Fusion Engineering and Technology: Although there are also fusion R&D needs related to achieving reliable, steady-state operation of the plasma, there is also a need for (a) plasma-support technology (such as magnets and heating systems), and (b) a fusion nuclear technology program (such as tritium production blankets, first wall, divertor, tritium handling and processing, and gas and liquid metal coolants). Both plasma engineering and nuclear technology will require a structural materials program to develop long-lifetime materials. The materials program is perhaps the most crucial short-term need.

10.2.2 Fuel Cycle Needs

1. Neutron-balance needs: Explore options that exploit the neutron-balance benefits of hybrids such as (1) in situ breed-and-burn and (2) fuel creation and/or transmutation of long-lived fission products (LLFP).

2. High-support-ratio options: Explore options that target high support ratio for transuranic transmutations. For example, what are the consequences of using advanced fuel cycle technologies, and are there any performance differences in subcritical operation?

Detailed, systematic analysis of these fuel cycle strategies should reveal any distinctions between the hybrid and fission fuel cycle options.

10.2.3 Hybrid Blanket Needs

1. Fusion-fission hybrid blanket neutronics: The ability to simultaneously meet tritium breeding requirements and fission fuel breeding or transmutation goals claimed by the advocates must be based on conceptual designs and neutronics analysis including more complete structure, coolants, penetrations, plasma fueling/control systems, etc. and including time variations coming from fuel burnup and reduced reactivity. Such consistent degree of detail and analysis will be needed to compare potential hybrid concepts.

2. Fusion technology and materials research: The desired use of sodium, lead and other liquid metal coolants; molten salt coolants; radiation resistant structural materials and cladding, high temperature gas cooling, radiation resistant insulators and diagnostics, etc. all represent technological areas of overlap between pure fusion, fission and hybrids. Joint R&D in these critical areas affecting thermal-hydraulics and safety could draw upon capabilities and produce benefits in both communities as well as inform the advancement of hybrid concepts.

3. Fuels research: Fuel forms considered for fission applications such as pebble fuels, metal fuels, inert matrix fuels, dissolved fuels are also identified for possible use in hybrids. Research on techniques to extend burn-up in critical and subcritical systems, and unique aspects of these fuels in a fusion environment such as magnetic field interactions for magnetic fusion and pulsed load effects for inertial systems, are important areas to assess fuel use in hybrids and increase the fuel database for fission.

10.2.4 Fusion-Fission Hybrid Concept Needs

1. Generic needs: Although the constraints vary from system to system, all programs need development of materials that can function in the fusion environment. The further study of possible fuel cycles and/or blankets will be of major importance in realizing the potential of all hybrids or pure fusion systems.

2. Magnetic fusion needs: The ability to demonstrate sustainment of all magnetic fusion concepts is critical. This demonstration requires the development of appropriate heating and current drive systems, as well as divertor and edge plasma control systems. In particular, long-pulse neutral beams and RF heating and current drive systems are needed. To many, the use of long-pulse gyrotrons seems particularly attractive. The interaction of the plasma dynamics with the fission core dynamics must be studied further. Off-normal events may introduce complex control problems. Systems studies should be carried out to assess the interaction of the physics constraints with the engineering constraints of the combined systems. These studies should inform the possibilities for hybrid design.

3. Inertial confinement needs: Beyond the target physics and experiments needed to demonstrate ignition and target gain of about 30 or more (or confidence that this result can be achieved), R&D is needed to develop the capability to operate at the required rep rate (5 to 15 per second for lasers and heavy ion beams, and

approximately 0.1 Hz for Z-pinches). Specific R&D needs include: (a) high-rep-rate drivers with adequate efficiency; (b) automatic target fabrication at an acceptable cost; (c) target inject, tracking, and beam engagement or target assembly insertion for Z-pinch; and (d) chamber environment recovery between shots (for example, to reestablish liquid or gas protection and allow target injection and beam propagation). All of this R&D is also needed for pure inertial fusion energy (IFE), but the target gain, target yield, and/or rep-rate may be lower in a hybrid because of the added energy multiplication in the fission blanket. As with magnetic fusion energy (MFE), systems studies that integrate physics, engineering, safety, and economics aspects are needed to identify an attractive design space and inform high-priority R&D needs.

Appendix A : DOE Charge Letter



Department of Energy
Washington, DC 20585

July 9, 2009

Dear Colleague,

The Office of Science's Office of Fusion Energy Science (SC/OFES), the National Nuclear Security Administration (NNSA), and the Office of Nuclear Energy (NE) are planning to hold a workshop focusing on the technical aspects of Fusion-Fission Research (FFR). The workshop is scheduled to take place from September 30 until October 2, 2009 at the Gaithersburg Hilton, 620 Perry Parkway, Gaithersburg, Maryland.

From the OFES perspective, this workshop is one of several that are taking place during 2009 to obtain community input that will help OFES to develop a long range strategic plan to guide the OFES program during the next 15-20 year period.

Professor Jeffrey P. Freidberg of the Massachusetts Institute of Technology's Plasma Science and Fusion Center and Dr Phillip Finck, Associate Laboratory Director for Nuclear Energy at the Idaho National Laboratory, have generously agreed to serve as the Chair and Co-Chair, respectively, for this activity. The elements of the workshop structure including the individuals who will serve as members of the workshop team have not yet been established. We will communicate those details to you as soon as they become available.

The purpose of the workshop will be to carry out an assessment of the areas in which fusion-fission devices might be useful such as the production of fuel for fission reactors, direct electricity production, and closing the nuclear fuel cycle by transmuting spent nuclear fuel from fission reactors. In carrying out this assessment, comparisons to other options that might be used for the same purposes (e.g., fast reactors, accelerator-driven transmutation, etc.) will be necessary.

In this assessment, the workshop will explore technical aspects of various fusion-fission concepts and the research needed to further develop them. This will assist DOE in clarifying the long-term potential of combining aspects of fusion and fission, in identifying research thrusts needed to develop the knowledge for a fusion-fission device, and in identifying the scientific grand challenges associated with fusion-fission.

While the FFR workshop itself will take place over three days, preparation will be critical if it is to successfully meet its aims. These preparations will take place over the next three months with the formation of Working Groups. They will carry out conference calls and possibly smaller workshops dealing with specific portions of the FFR field. The workshop will produce a report that will be available for general distribution. A key objective of developing the report is to



Printed with soy ink on recycled paper

provide an updated overview of the technical challenges and research opportunities and needs associated with fusion-fission hybrids. It will also highlight the potential as well as the limitations associated with fusion-fission hybrid concepts. The leading near-term target for this information will be to provide technical information that can be used by OFES in developing the strategic plan as described above.

A website to keep the members of the fusion and fission research communities updated on the progress of this activity will soon be up and running. We will distribute the address of this website to everyone who may be interested.

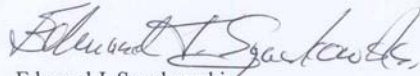

Edmund J. Synakowski
Associate Director of the Office of Science
for the Office of Fusion Energy Sciences

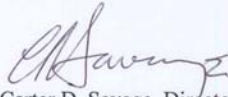

Carter D. Savage, Director
Fuel Cycle Research and Development
Office of Nuclear Energy



Dr. Christopher Deeney
Director
Office of Inertial Confinement Fusion
and the National Ignition Facility Project

APPENDIX B

Subcommittee Chairs and Members

Workshop Attendees

I Introduction (Freidberg and Finck)

1. Jeff Freidberg (MIT)
2. Phillip Finck (INL)
3. Vincent Tang (LLNL)
4. Steve Dean (Fusion Power Associates)
5. Andrew Kadak (MIT)
6. Massimo Salvatores (CEA)
7. Roald Wigeland (INL)
8. Don Steiner (RPI-retired)
9. Bill Stacey (G.Tech)

II The Fusion-fission hybrid primer (Freidberg and Finck)

1. Jeff Freidberg (MIT)
2. Phillip Finck (INL)
3. Vincent Tang (LLNL)
4. Steve Dean (Fusion Power Associates)
5. Andrew Kadak (MIT)
6. Massimo Salvatores (CEA)
7. Roald Wigeland (INL)
8. Don Steiner (RPI-retired)
9. Bill Stacey (G.Tech)

III Fusion-fission fuel cycles for waste disposal (Hill) bobhill@anl.gov

1. Yousry Gohar (ANL)
2. Kemal Pasamehmetoglu (INL)
3. Jim Tulenko (U of Florida)
4. Swadesh Mahajan (U. Texas)
5. Ralph Moir (LLNL)
6. Rob Goldston (PPPL)

IV Proposed hybrid reactors (Weitzner)

weitzner@cims.nyu.edu

1. Bill Stacey (G. Tech)
2. Mike Kotschenreuther – ST (U. Texas)
3. Erik Storm – LIFE (LLNL)
4. Dmitri Ryutov – mirror (LLNL)
5. Wally Manheimer – tokamak (NRL)
6. Leonid Zakharov – lithium walls (PPPL)
7. Jeff Harris – stellarator (ORNL)
8. John Sarff – RFP (U. Wisconsin)
9. Wayne Meier – IFE (LLNL)
10. Benjamin Cipiti Z-Pinch (Sandia)
11. Martin Peng ST (ORNL)

12. George Miley (UIUC)
13. John Slough (UW)
14. Glen Wurden (LANL)

V The hybrid blanket (Morley)

morley@fusion.ucla.edu

1. Mohamed Abdou (UCLA)
2. Per Peterson (UCB)
3. Jess Gehin (ORNL)
4. David Petti (INL)
5. Jake Blanchard (UW-Madison)

VI Alternative approaches (Machiels)

amachiels@epri.com

1. Dr. John Kessler (EPRI)
2. Peter Swift (Sandia)
3. Richard Sheffield (LANL)
4. Gary Rochau

VII The international Hybrid program (Sadowski)

sadowskiwl@comcast.net

1. Valentin Smirnov (Kurchatov Institute)
2. Evgeny Avrorin (Federal Nuclear Center)
3. Englen Azizov (Troitsk Institute)
4. Alex Stanculescu (IAEA)
5. Edward Kruglyakov (Budker Institute)
6. Yican Wu (Institute of Plasma Physics, China)
7. Vadim Simonenko (Federal Nuclear Center)
8. Sergey Mirnov (Troitsk Institute)
9. Yian Lei (Beijing University)
10. Boris Kuteev (Kurchatov Institute)
11. Junghoon Han (Seoul National University)
12. Volodymyr Moiseenko (Kharkov Institute)
13. Yousry Gohar (ANL)
14. Bruno Coppi (MIT)

VIII Committee of Skeptics (Sheffield)

jsheffield@utk.edu

1. Kathy McCarthy (INL)
2. Dale Meade (FIRE)
3. Mike Mael (Columbia)
4. Ian Hutchinson (MIT)
5. Bedros Afeyan (Polymath Res. Inc.)
6. Robert Hanrahan (DOE)
7. Don Steiner (RPI-retired)

IX High Level Findings and Research Needs

Contributions from entire workshop

X Technical Findings and Research Needs

As listed

Fusion-Fission Workshop Attendees

September 30-October 2, 2009

Name	Affiliation
Afeyan, Bedros	Polymath Research Inc.
Anklam, Thomas	LLNL
Avrorin, Evgeni	Snezhinsk
Azizov, Englen	Trinita
Bari, Bob	BNL
Blanchard, Jake	UWI
Bolton, Curt	DOE/OFES
Brown, Ben	DOE/SC-2
Callis, Rich	GA
Cerfon, Antoine	MIT
Colestock, Pat	LANL
Correll, Don	LLNL
Dagazian, Rostom	DOE/OFES
Damkroger, Trish	LLNL
Dean, Steve	Fusion Power Associates
Eckstrand, Steve	DOE/OFES
Finck, Phil	INL
Fluss, Michael	LLNL
Freidberg, Jeff	MIT
Gehin, Jess	ORNL
George, TV	DOE/OFES
Gohar, Yousry	ANL
Goldner, Frank	DOE/NE
Goldstein, Bill	LLNL
Halsey, Bill	LLNL
Han, Jung-Hoon	Seoul National U, South Korea

Hanrahan, Robert	DOE/NNSA
Hassam, Adil	UMD
Haynes, Mark	GA
Hauer, Allan	DOE/NNSA
Herrera-Velázquez, Julio	UNAM
Heymer, Adrian	NEI
Hill, Bob	ANL
Hutchinson, Ian	MIT
Johnson, Milt	Longenecker & Assoc
Kadak, Andy	MIT
King, Wayne	LLNL
Kotschenreuther, Mike	UTX
Kritz, Arnold	Lehigh University
Kuteev, Boris	Kurchatov Institute
Leeper, Ray	SNL
Lei, Yi-An	Institute of Applied Physics and Computational Mathematics
Levedahl, Kirk	DOE/NNSA
Li, Bai Wen	Institute of Applied Physics and Computational Mathematics
Machiels, Albert	EPRI
Mahajan, Swadesh	UTX
Mailhot, Christian	LLNL
Maloy, Stuart	LANL
Mandrekas, John	DOE/OFES
Manheimer, Wally	NRL
Meier, Wayne	LLNL
Menard, Jonathan	PPPL
Miley, George	UIL
Mima, Kunioki	Japan
Moir, Ralph	LLNL
Moiseenko, Vladimir	Uppsala University
Morley, Neil	UCLA
Navratil, Gerry	Columbia

Neilson, Hutch	PPPL
Obenschain, Steve	NRL
Opdenaker, Albert	DOE/OFES
Petti, Dave	INL
Podder, Nermil	DOE/OFES
Porkolab, Miklos	MIT
Prager, Stewart	PPPL
Rochau, Gary	SNL
Romero-Talamos, Carlos	UMD
Ryutov, Dmitri	LLNL
Sadowski, Walt	UMD
Salvatores, Max	CEA France
Sarff, John	Univ of Wisc
Savage, Buzz	DOE
Schroeder, Lee	TechSource
Seidl, Peter	LBL
Sheffield, John	UTN
Sheffield, Richard	LANL
Simonen, Tom	LLNL
Singh, Bhupinder	DOE/NE
Smirnov, Velentin	Kurchatov
Snyder, Marty	NYU
Sperry, Lee	LANL
Stacey, Bill	GA Tech
Stark, Richard	DOE/NE
Stambaugh, Ron	GA
Stanculescu, Alexander	IAEA
Steiner, Don	RPI
Storm, Erik	LLNL
Stout, Daniel	TVA
Swift, Peter	SNL
Synakowski, Ed	DOE/OFES

Sze, Dai-Kai	UCSD
Taiwo, Temitope	ANL
Tang, Vincent	LLNL
Tulenko, James	U FL
Uckan, Nermin	ORNL
Waltz, Ronald	GA
Weitzner, Harold	NYU
Wigeland, Roald	INL
Wooley, Bob	PPPL
Wu, Yi-Can	Institute for Plasma Physics, Hefei, CN
Wurden, Glen	LANL
Zakharov, Leonid	PPPL

Appendix C

Previous Studies of Sustainability of the Nuclear Fuel Cycle

Prospects for energy needs show the possibility of a strongly increasing demand for nuclear power. In such a scenario, sustainability becomes a predominant concern, which means that preservation of natural resources; waste minimization and proliferation resistance are criteria as important as economy and safety.

As for fuel cycles, different options have been promoted, mainly open or close fuel cycle or the so-called Partitioning and Transmutation (P&T) strategy (see Refs. 1-7). With the open cycle, no sustainability is guaranteed, due to uranium availability and cost issues. Historically this option has been associated with LWRs, which use only ~1% of the Uranium resource. The closed fuel cycle has been historically associated with enhanced resource utilization, fuel reprocessing and Pu recovery. As for P&T, it has been historically associated with the waste minimization goal, and has been mostly discussed in the last two decades as an option “per se”.

Recently, within a wide international consensus, the Gen-IV initiative (see Refs.8-9) has defined a set of more general goals for future systems in four broad areas: Sustainability and Waste Minimization; Enhanced Economics, Safety and Reliability and Proliferation Resistance and Physical Protection, thus in practice including P&T goals, and collaborative projects have been launched, in particular in the field of TRU recycle (the GACID project).

Specifically, partitioning and transmutation (P&T) is considered as a means of reducing the burden on a geological repository. As plutonium and minor actinides (MA) are mainly responsible for the long-term radiotoxicity, when these nuclides are first removed from the irradiated fuel (partitioning) and then fissioned (transmutation), the remaining waste loses most of its long-term radiotoxicity. Moreover, the P&T strategy allows (in principle) a combined reduction of the radionuclide masses to be stored, their associated residual heat, and (as a potential consequence) the volume and the cost of the repository (see e.g. Refs. 10-12). Consequences of P&T on proliferation have also been discussed (see, e.g. Ref.13)

Different P&T scenarios have been envisaged, ranging from the TRU management with waste minimization and reduced proliferation risk, to the TRU or MA stocks reduction (see e.g. Ref. 14-15). All of them imply fuel reprocessing and recycling of actinides and possibly fission products in a fission reactor. Moreover, different reactor types (critical, with or without deep burn, or sub-critical external neutron source driven, see, among many others, Refs.16-22) have been investigated in order to find the optimum system to meet the combined requirement of sustainability and waste minimisation. However, the impact of advanced systems on fuel cycles has been pointed out as a major issue when evaluating the relative performance and interest of the numerous potential options that have been proposed and sometimes fully worked out with specific experimental validations (see e.g. Refs. 5, 19, 23-24)

References

1. NEA (1999) “Actinide and Fission Product Partitioning and Transmutation; Status and Assessment Report”, OECD, Paris.
2. NEA (2002), “Accelerator-driven Systems (ADS) and Fast Reactors (FR) in Advanced

- Nuclear Fuel Cycles”, OECD, Paris (France).
3. NEA (2002), “Trends in the Nuclear Fuel Cycle; Economic, Environmental and Social Aspects”, OECD, Paris.
 4. NEA (2005), “Fuels for Transmutation. A Status Report”, OECD-NEA Report 5419.
 5. NEA (2005), Advanced Fuel Cycles and Waste Management, OECD, Paris (France)
 6. NEA (2006), “Physics and Safety of Transmutation Systems. A status report”. OECD-NEA Report 6090
 7. NEA (2006), “French R&D on the Partitioning and Transmutation of Long-Lived Radionuclides”, OECD-NEA Report 6210
 8. Generation IV International Forum, *A Technology Roadmap for Generation IV Nuclear Energy Systems*, GIF-002-00, Idaho National Laboratory (2002).
 9. GEN IV International Forum, 2007 and 2008 Annual Reports.
 10. R.A. Wigeland et al “Separations and transmutation criteria to improve utilization of a geological repository”, Nucl. Technology 154, 95 (2006)
 11. H. Oigawa, et al., “Partitioning and Transmutation Technology in Japan and its Benefit on High-level Waste Management”, Global2007 (2007).
 12. von Lensa W. et al, Editors, 2007 “REDIMPACT: Impact of Partitioning, Transmutation and Waste Reduction Technologies on the Final Nuclear Waste Disposal” Schriften des Forschungszentrums Jülich, Volume 15.
 13. “Non proliferation impact assessment for the Global Nuclear Energy Partnership programmatic alternatives” NNSA, December 2008.
 14. M.Salvatores, “Nuclear Fuel Cycle Strategies Including Partitioning and Transmutation.” Nucl. Eng. and Design, 235 (2005) 805.
 15. M.Salvatores and J.Knebel, “Overview of Advanced Fuel Cycles for the 21st Century”, Int. Journal for Nucl. Power, p. 89- 94, February 2009
 16. Accelerator-driven Systems (ADS) and Fast Reactors (FR) in Advanced Fuel Cycles. A comparative study. OECD-NEA Report 2002.
 17. Mukayama T., in “Accelerator Driven Systems (ADS) and Fast Reactors in Advanced Fuel Cycles”, OECD Nuclear Energy Agency, NEA-3109-ADS, Paris (2002)
 18. Rubbia C. et al., “A European Roadmap for Developing Accelerator Driver Systems for Nuclear Waste Incineration”, available on the Internet at www.enea.it (April 2001)
 19. Stacey W. M., 2007, “Transmutation Missions for Fusion Neutron Sources”, Fusion Eng. and Design 82, 11-20
 20. M.Salvatores et al. “Fuel cycle analysis of TRU or MA burner fast reactors with variable conversion ratio using a new algorithm at equilibrium”, Nucl. Eng. and Design, June 2009
 21. T. K. Kim, T. A. Taiwo, W. S. Yang, R. N. Hill, and F. Venneri, “Assessment of Deep Burnup Concept Based on Graphite Moderated Gas-Cooled Thermal, Reactor”, Proc. PHYSOR 2006 – Advances in Nuclear Analysis and Simulation, Vancouver, British Columbia, Canada, September 10-14, on CD-ROM, American Nuclear Society, Lagrange Park, IL. (2006).

22. Mizuno, T., et al., “Advanced Oxide Fuel Core Design Study for SFR in the Feasibility Study in Japan”, Proceedings of Global 2005, Tsukuba, Japan, 9-13 October 2005.
23. Taiwo et al., 2006 “Assessment of a Heterogeneous PWR Assembly for Plutonium and Minor Actinide Recycle” Nucl. Technology, Vol. 155, No.1, p. 34-54.
24. Nuclear Fuel Cycle Transition Scenario Studies. Status Report 2009. NEA

Note:

- a) A large number of experimental validation results are available at laboratory or pre-industrial level, in the field of advanced reprocessing (partitioning), fuels for transmutation, new material and associated technologies. Most of the results have been reported in a series of OECD-NEA sponsored biannual workshops (International Exchange Meetings on P&T, since 1990. The last one took place in Mito, Japan in Oct. 2008)
- b) Many significant references can also be found within the DOE-AFCI documentation since 2003. In particular an excellent and up-to-date overview has been given at the FY 2009 Office of Nuclear Energy University Program Workshop, Bethesda, August 2008;
- c) Other relevant international collaboration initiatives that are directly related to advanced fuel cycles:
 - USDOE, Global Nuclear Energy Partnership (GNEP) Steering Group Action Plan; An Action Plan for the Safe, Secure Global Expansion of Nuclear Energy, Adopted 13, December 2007.
 - Press release from USDOE on February 1, 2008, United States, France and Japan Increase Cooperation on Sodium-Cooled Fast Reactor Prototypes.

Finally, the IAEA conducted a Coordinated Research Program on “Studies of Advanced Technology Options for Effective Incineration of Radioactive Wastes”. In the final TECDOC published in 2008, one full Chapter was devoted the Fission-Fusion Hybrid.