

Leaking Profits

The U.S. Oil and Gas Industry Can Reduce Pollution, Conserve Resources, and Make Money by Preventing Methane Waste

March 2012



Principal Author

Susan Harvey, *Harvey Consulting, LLC*

Contributing Authors

Vignesh Gowrishankar, Ph.D., *Natural Resources Defense Council*

Thomas Singer, Ph.D., *Natural Resources Defense Council*

ACKNOWLEDGMENTS

The authors would like to thank the William and Flora Hewlett Foundation for providing funding for this report. We would also like to thank the following individuals for their valuable contributions and peer review: Amy Mall, senior policy analyst, NRDC; George Peridas, scientist, NRDC Climate Center; Mark Fesmire, Alaska Region director, Bureau of Safety and Environmental Enforcement, U.S. Department of the Interior; Geir Vollsæter, director, Green World Advisors; and Erik Schlenker-Goodrich, director of the Southwest Office of Climate and Energy Program, Western Environmental Law Center.

This report relies heavily on the excellent work of the U.S. Environmental Protection Agency's Natural Gas STAR Program, and the innovative engineering excellence of many oil and gas companies that have developed, tested, and implemented new greenhouse gas emission control strategies. Harvey Consulting, LLC. (HCLLC) acknowledges the time, dedication, and commitment of the EPA staff to develop and maintain the Natural Gas STAR Program, and the corporations that have voluntarily committed to programs to reduce methane emissions.

About the Natural Resources Defense Council

The Natural Resources Defense Council is a national nonprofit environmental organization with more than 1.3 million members and online activists. Since 1970, our lawyers, scientists, and other environmental specialists have worked to protect the world's natural resources, public health, and the environment. NRDC has offices in New York City, Washington, D.C., Los Angeles, San Francisco, Chicago, Montana, and Beijing.

About Harvey Consulting LLC

Susan Harvey has 25 years of experience as a Petroleum and Environmental Engineer, working on oil and gas exploration and development projects. Ms. Harvey is the owner of Harvey Consulting, LLC, a consulting firm providing oil and gas, environmental, regulatory compliance advice and training to clients. Ms. Harvey held engineering and management positions at both Arco and BP. Ms. Harvey has planned, engineered, executed and managed both onshore and offshore exploration and production operations, and has been involved in the drilling, completion, stimulation, testing and oversight of hundreds of wells in her career. Ms. Harvey's experience also includes air and water pollution abatement design and execution, best management practices, environmental assessment of oil and gas project impacts, and oil spill prevention and response planning. Ms. Harvey taught air pollution control engineering courses at the University of Alaska in the Graduate Engineering Program.

NRDC Director of Communications: Phil Gutis
NRDC Deputy Director of Communications: Lisa Goffredi
NRDC Publications Director: Alex Kennaugh
NRDC Editor: Jennifer Freeman
Design and Production: Tanja Bos

TABLE OF CONTENTS

- 1. Executive Summary..... 3
- 2. Methane Control: Opportunities and Issues.....8
 - 2.1 Incentives to Invest9
 - 2.2 Methane Emission Tracking9
 - 2.3 Uncertainty in Emission Estimates.....12
 - 2.4 Voluntary Control with EPA Natural Gas Star.....13
- 3. Analytic Approach.....15
 - 3.1 Profitability.....16
 - 3.2 Examination of Methane Control Options16
 - 3.3 Methane Emission Reporting Units.....17
- 4. Ten Profitable Technologies: An Analysis18
 - 4.1 Green Completions18
 - 4.2 Plunger Lift Systems23
 - 4.3 Tri-Ethylene Glycol Dehydrator Emission Controls26
 - 4.4 Desiccant Dehydrators29
 - 4.5 Dry Seal Systems30
 - 4.6 Improved Compressor Maintenance.....32
 - 4.7 Low-Bleed or No-Bleed Pneumatic Controllers34
 - 4.8 Pipeline Maintenance and Repair36
 - 4.9 Vapor Recovery Units39
 - 4.10 Leak Monitoring and Repair.....42
- 5. Conclusion and Policy Recommendations.....45
- Appendix A: Cost-Effectiveness Analysis of Methane Control Technologies.....47
- Appendix B: List of Acronyms56
- Appendix C: Methane Emission Source Detail.....57
- Endnotes59

FIGURES AND TABLES

FIGURES

Figure 1: Oil & Gas Production, Processing, Transmission, Refining and Distribution Systems Simplified Schematic	4
Figure 2: Methane from the O&G Industry as a Percent of Total U.S. Methane Emissions	4
Figure 3: O&G Industry Methane Emission Reduction Potential by Technology.....	6
Figure 4: Current Average Gas Price \$4/Mcf.....	8
Figure 5: O&G Industry Methane Reduction and Remaining Opportunity.....	9
Figure 6: Natural Gas System Methane Emission Sources.....	10
Figure 7: Liquid Petroleum System Methane Emission Sources	10
Figure 8: O&G Industry Methane Emissions 1990-2009	13
Figure 9: Payout Period Diagram.....	16
Figure 10: Gas Well Flaring.....	19
Figure 11: Green Completion Equipment Schematic.....	19
Figure 12: Green Completion Equipment.....	20
Figure 13: Green Completion Evaluation Flowchart	23
Figure 14: Plunger Lift System Schematic.....	24
Figure 15: Plunger Lift System Evaluation Flowchart.....	25
Figure 16: Glycol Dehydration Unit Schematic.....	26
Figure 17: TEG Dehydrator Emission Control Evaluation Flowchart.....	28
Figure: 18 Desiccant Dehydrator Schematic	29
Figure 19: Desiccant Dehydrator Evaluation Flowchart	30
Figure 20: Centrifugal Compressor Leaks Schematic	31
Figure 21: Centrifugal Compressor Dry Seals.....	31
Figure 22: Wet to Dry Compressor Seal Evaluation Flowchart	32
Figure 23: Reciprocating Compressor Rod Packing Leaks Schematic.....	33
Figure 24: Rod Packing Replacement Evaluation Flowchart.....	34
Figure 25: Pneumatic Controller.....	34
Figure 26: Pneumatic Controller Locations in Natural Gas Production	34
Figure 27: Pneumatic Controller Evaluation Flowchart.....	36
Figure 28: Pipeline Hot Tapping Schematic.....	36
Figure 29A: Pipeline Pump-Down Technique Using In-Line Compressor Schematic	37
Figure 29B: Pipeline Pump-Down Technique Using Portable Compressor Schematic	37

Figure 30: Pipeline Maintenance and Repair Evaluation Flowchart	38
Figure 31: Vapor Recovery Unit.....	39
Figure 32: Vapor Recovery Unit Schematic.....	39
Figure 33: Vapor Recovery Unit Evaluation Flowchart.....	41
Figure 34: Hand Held Infrared Camera	42
Figure 35: Remote Methane Leak Detector	42
Figure 36: Leaking Valve as shown by Infrared Gas Detecor	42
Figure 37: Leak Monitoring and Repair Evaluation Flowchart.....	44

TABLES

Table 1: Methane Emissions (in Billion Cubic Feet).....	5
Table 2: Methane Emission Sources and Control Technologies.....	11
Table 3: Methane Emission Control Opportunity.....	15
Table 4: Methane Capture Technology Costs and Benefits.....	18
Table 5: Methane Capture Potential from TEG Dehydrator Controls	27
Table 6: Crude Oil Tank Vapor Recovery Unit Economics	40

APPENDIX A

Table A1: Cost-effectiveness of green completions.....	48
Table A2: Cost-effectiveness of plunger lift systems.....	49
Table A3: Cost-effectiveness of TEG dehydrator controls.....	49
Table A4: Cost-effectiveness of desiccant dehydrators	50
Table A5: Cost-effectiveness of replacing wet seals in centrifugal compressors with dry seals.....	50
Table A6: Cost-effectiveness of replacing rod packing in reciprocating compressors.....	51
Table A7: Cost-effectiveness of replacing high-bleed pneumatic controllers with low-bleed pneumatic controllers	52
Table A8: Cost-effectiveness of replacing high-bleed pneumatic controllers with instrument-air pneumatic controllers.....	53
Table A9: Cost-effectiveness of installing vapor recovery units	54
Table A10: Cost-effectiveness of leak monitoring and repair systems.....	55

APPENDIX C

Table C1: Natural Gas System Methane Emission Sources.....	57
Table C2: Petroleum System Methane Emission Sources.....	58

1. EXECUTIVE SUMMARY

Methane is valuable as a fuel, but it is also a greenhouse gas at least 25 times more potent than carbon dioxide over a 100 year period, with even greater relative impacts over shorter periods. Methane makes up as much as 90 percent of natural gas. Currently the United States loses at least 2 to 3 percent of its total natural gas production each year when gas is leaked or vented to the atmosphere. Natural gas is routinely allowed to escape into the atmosphere from oil and gas industry equipment and processes. This is a waste of a valuable fuel resource as well as a source of local pollution and climate change.

A focus on reducing methane waste can produce not only benefits for the climate but also substantial profits for oil and gas companies, and revenues for royalty owners including taxpayers, who own public lands. This report focuses on 10 profitable and widely applicable methane emission reduction opportunities in the United States oil and gas (O&G) industry. If these technologies are used throughout the industry, they have the potential to reduce U.S. methane emissions by more than 80 percent of current levels, based on the U.S. Environmental Protection Agency's (EPA) estimates, an amount greater than the annual greenhouse gas emissions from 50 coal fired power plants. This methane, if captured and sold, can bring in billions of dollars in revenues while benefiting the environment.

A combination of voluntary and mandatory programs implemented by the EPA and many states has already reduced the industry's U.S. methane emissions by more than 20 percent. Given industry practice to date, it appears that available control technologies, while profitable, do not provide sufficient incentive to drive further voluntary reductions. While voluntary programs have resulted in some progress, additional mandatory programs are needed to get closer to the more than 80 percent methane reduction level that this report demonstrates is within our reach.

Figure 1: Oil and Gas Production, Processing, Transmission, Refining, and Distribution System Simplified Schematic

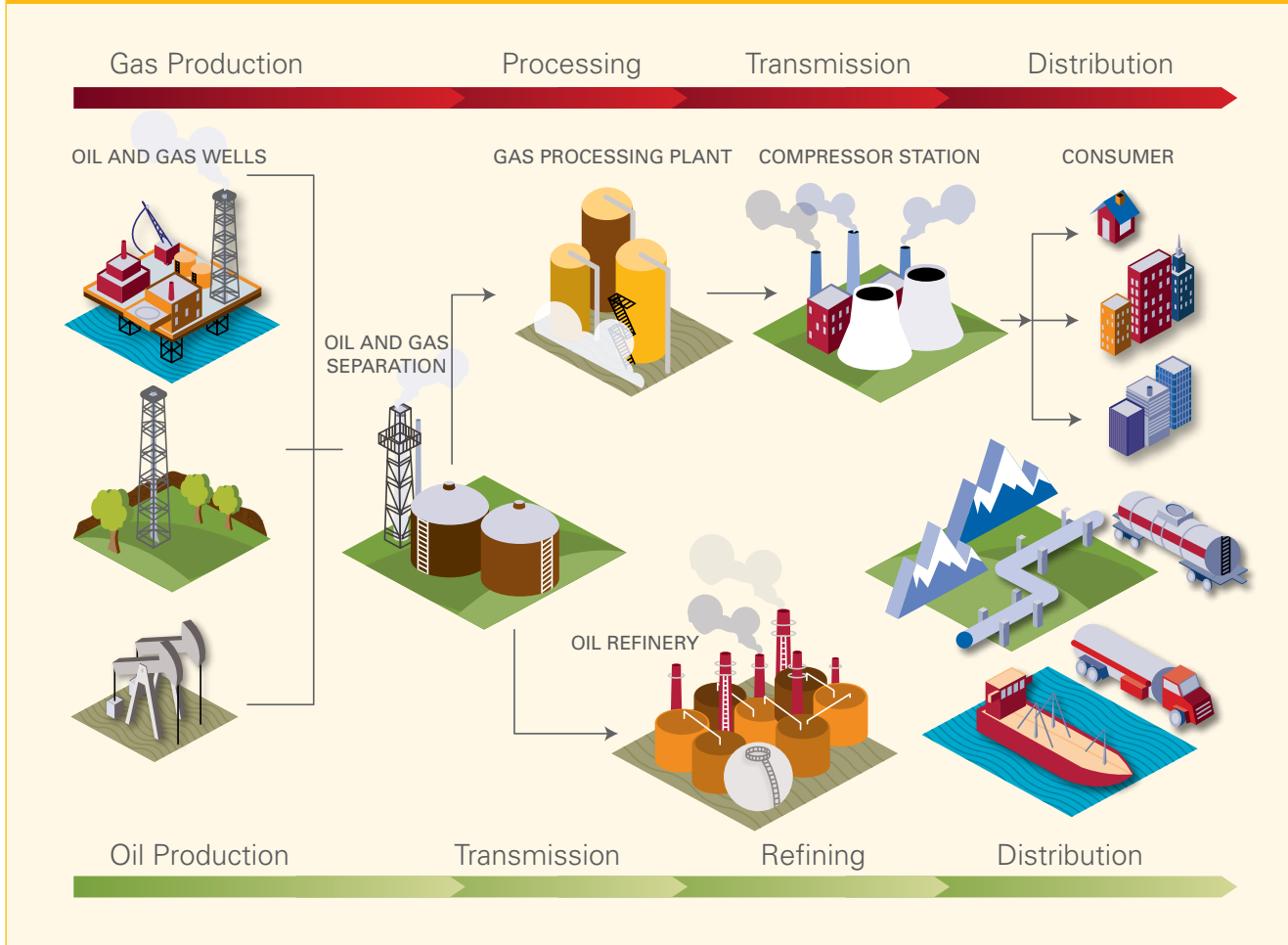

The U.S. O&G industry, which includes both liquid petroleum (crude oil, condensate, and natural gas liquids) and natural gas systems (Figure 1), produced 26,000 Bcf (billion cubic feet) of gas in 2009.¹ The industry lost an estimated 623 Bcf of methane to the atmosphere in 2009, a loss of 2.4 percent of the total U.S. gas produced. This amount of methane, 623 Bcf, is roughly 37 percent of total U.S. methane emissions (Figure 2).² Natural gas systems contribute most of the O&G industry's methane emissions, 547 Bcf/year (88 percent of the total). Liquid petroleum systems, which currently result in methane emissions of about 76 Bcf/year (12 percent of the total), represent an additional emission source (Table 1).

The 10 technologies covered in this report are technically proven, commercially available, and profitable ways for operators to capture methane that would otherwise be leaked or vented to the atmosphere from oil and gas production, processing and transportation systems.³ These 10 methane control solutions are only a starting point for the O&G industry. The EPA's Natural Gas STAR Program, the O&G industry, and equipment vendors have identified nearly 100

methane control options that have merit.⁴ We selected these 10 technologies because they have been proven by the EPA and industry to be both profitable and technically feasible, time and time again.

Figure 2: Methane from the O&G Industry as a Percent of Total U.S. Methane Emissions

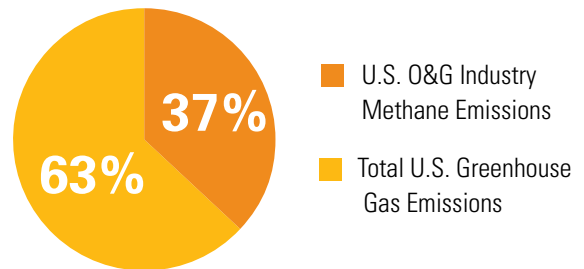

Note: Methane made up 10.3 percent of U.S. greenhouse gas emissions in 2009.
Source: U.S. EPA 2011 *Greenhouse Gas Inventory*

Together, these 10 technologies have the ability to capture more than 80 percent of the O&G sector's methane emissions:

1. **Green Completions** to capture oil and gas well emissions
2. **Plunger Lift Systems** or other well deliquification methods to mitigate gas well emissions
3. **Tri-Ethylene Glycol (TEG) Dehydrator Emission Controls** to capture emissions from dehydrators
4. **Desiccant Dehydrators** to capture emissions from dehydrators
5. **Dry Seal Systems** to reduce emissions from centrifugal compressor seals
6. **Improved Compressor Maintenance** to reduce emissions from reciprocating compressors
7. **Low-Bleed or No-Bleed Pneumatic Controllers** used to reduce emissions from control devices
8. **Pipeline Maintenance and Repair** to reduce emissions from pipelines
9. **Vapor Recovery Units** used to reduce emissions from storage tanks
10. **Leak Monitoring and Repair** to control fugitive emissions from valves, flanges, seals, connections and other equipment

Methane control technologies provide economic, health, safety, and environmental benefits for both operators and the public. These control technologies reduce not only greenhouse gas emissions, but also potentially explosive vapors, hazardous air pollutants, and volatile organic compounds (VOC), improving worker safety and limiting corporate liability. Using these technologies, captured methane can be turned into a supply of natural gas to meet ever-growing market demands, or used as a source of energy for operations. When development occurs on public lands, use of the technologies can result in royalty payments to the government from the sale of captured methane, as well as improved stewardship of our natural resources.⁵

In its 2011 *Greenhouse Gas Inventory*, the EPA estimated that the O&G industry reduced emissions by 168 Bcf in 2009. At a price of \$4 per thousand standard cubic foot (Mcf), the industry generated \$672 million in gross revenue by keeping this gas in the revenue stream. About a quarter (39 Bcf) of the emissions reductions came from Federal regulations such as NESHAPs (National Emission Standards for Hazardous Air Pollutants), and three quarters (129 Bcf) from voluntary emissions reductions under the EPA's Natural Gas STAR program.

The 10 technologies discussed in this report can capture more than 80 percent of the 623 Bcf wasted by the O&G industry. Selling this methane at the average 2011 price of \$4/Mcf would generate more than \$2 billion annually.

This is equivalent to reducing greenhouse gas emissions from more than:

- 40,000,000 passenger vehicles
- The electric use of 25,000,000 homes
- 50 coal fired power plants, or
- 500,000,000 barrels of oil⁶

Despite these environmental and financial benefits, in some instances there are technical, financial and institutional barriers that prevent O&G operators or companies from voluntarily investing in methane control. Nevertheless, most of the methane control technologies highlighted in this report can be achieved simply by modernizing outmoded business practices, commanding resource and budget allocations, and instilling a corporate commitment to methane emission reduction. If better operating conditions and profits are not enough incentive to implement these projects, policies that mandate emissions control will be necessary to achieve the full potential of these methane control technologies.

EMISSION REDUCTION POTENTIAL OF 10 PROFITABLE TECHNOLOGIES

Each methane emission control technology evaluated in this report contributes to the goal of treating methane as a valued resource and keeping it out of the atmosphere. Just two methane control technologies, green completions and plunger lift systems, can potentially address nearly 40 percent of methane emissions (Figure 3). All 10 technologies discussed in this report together could address an estimated 88 percent of emissions from the O&G industry. This is equivalent to reducing gross emissions from 3 percent of production to about 0.4 percent of production.

Table 1: Methane Emissions (in Billion Cubic Feet)

	Natural Gas System	Petroleum System	O&G Industry
Gross emissions	715	76	791
Emissions reductions*	168	-	168
Net emissions	547	76	623

*From Natural Gas STAR program and federal regulations
Source: U.S. EPA 2011 *Greenhouse Gas Inventory*

Only gross emissions estimates are available from the EPA in sufficient detail by source to use as a basis for analysis. The following emissions estimates, from the EPA's 2011 *Greenhouse Gas Inventory*, are based on gross emissions (corresponding to total gross emissions of 791 Bcf/year).⁷

- **Green completions**, also known as reduced emissions completions, are closed loop systems that capture liquids and gases coming out of the well during "completions" using temporary processing equipment brought to a well site, then routing fluids and gases to a tank for separation to enable sale of gas and condensate. Historically, the fluids and gases flowing back out of the well have been routed to an open air pit or perhaps a tank, allowing substantial amounts of methane to vent directly into the atmosphere. The EPA estimates that approximately 8,200 Mcf of natural gas is emitted per well completion, on average. Well completions, workovers and cleanups

Figure 3: O&G Industry Methane Emission Reduction Potential by Technology

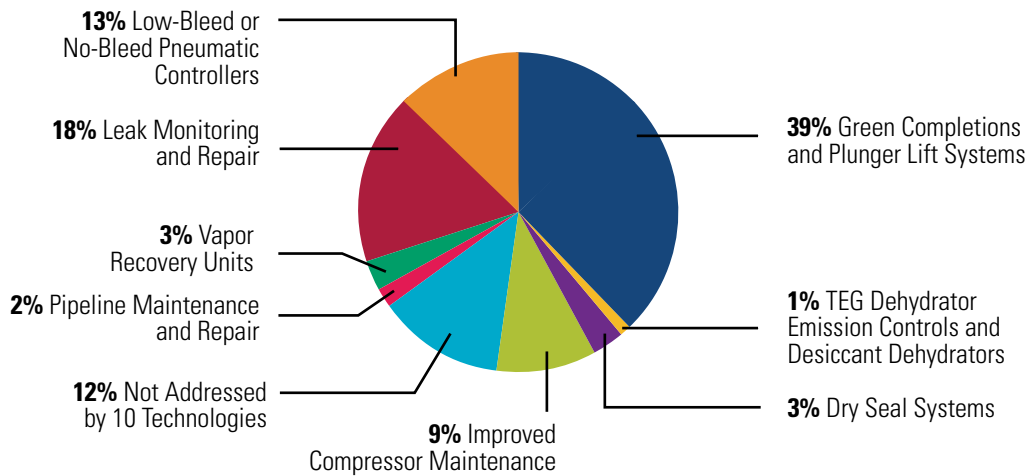

Note: 2009 gross O&G industry methane emission was 791 Bcf. The 10 technologies can address all but 12 percent of these emissions. Based on data from U.S. EPA 2011 *Greenhouse Gas Inventory*.

emit approximately 305 Bcf gross of methane per year. Green completions may be used to control considerable emissions from well completions and workovers (68 Bcf). Green completions can also be used to control a portion of the 237 Bcf/year in emissions from cleanups of low pressure wells (also known as liquids unloading).

- **Plunger Lift Systems** are installed on gas wells that stop flowing when liquid (water and condensate) accumulates inside the wellbore. These systems lift accumulated liquids in the wellbore to the surface. Using this method, methane gas can be captured and sold rather than vented to atmosphere as waste. Approximately 4,500 to 18,000 Mcf/year of methane gas is emitted per well, mainly from normal cleanup operations. This contributes to the EPA's estimate of total gross emissions of 237 Bcf/year from liquids unloading.
- **TEG Dehydrator Emission Controls** or Desiccant Dehydrators can be used to reduce methane waste while removing moisture from natural gas from oil or gas wells. Methane is often vented during the process of dehydrating gas, but it can be captured using either emission control equipment placed on TEG dehydrators, or with desiccant dehydrators. Desiccant dehydrators dry gas by passing it through a bed of sacrificial hygroscopic salt (the desiccant); there are no pumps, contactors, regenerators, or reboilers. Only a small amount of methane is released intermittently when the unit is opened to replace the salt. Desiccant dehydrators are best suited for low gas flow rates and low gas temperatures. Alternatively, where glycol dehydrators are still required, there are emission control solutions that can capture methane gas for use as fuel. The EPA estimates that 20,000 Mcf/year of natural gas is emitted per well on average (including both old and new wells), and that smaller dehydrators still cumulatively emit approximately

8 Bcf of methane per year despite mandatory emission controls on most large dehydrator systems. A significant fraction of this 8 Bcf/year of gross emissions from this source can and should be captured.

- **Dry Seal Systems** can be used throughout the O&G industry to reduce emissions from centrifugal compressors that compress natural gas so that it can be efficiently moved through a pipeline. Methane can leak from the seals in centrifugal compressors and the rod packing mechanisms in reciprocating compressors. Installation of improved dry seals in centrifugal compressors, and **improved compressor maintenance** by replacing worn rod packing in reciprocating compressors, have the potential to significantly reduce the amount of methane emitted. The EPA estimates that leaking compressors emit about 102 Bcf/year (27 Bcf/year from centrifugal compressors and 75 Bcf/year from reciprocating compressors). A significant fraction of this can and should be captured.
- **Low-Bleed or No-Bleed Pneumatic Controllers** can be used throughout the O&G industry to reduce emissions while regulating pressure, gas flow, and liquid levels, and automatically operating valves. High-bleed pneumatic devices are designed to release methane gas to the atmosphere. Converting high-bleed gas devices to low-bleed devices, or moving away from gas-operated devices altogether in favor of instrument air, reduces methane emissions. The EPA estimates that 80 percent of all high-bleed pneumatic devices can be retrofitted, and that there is an opportunity to reduce a very large fraction of the 99 Bcf/year of gross methane emissions from pneumatic controllers.

- **Pipeline Maintenance and Repair** can result in methane venting to the atmosphere when an oil or gas pipeline is cut or when methane is vented to reduce potential fire or explosion risk while the pipe is under repair. Instead, to mitigate methane release, subject to a thorough safety evaluation, gas can either be re-routed and burned as fuel during the repair and maintenance, or work can be conducted on the pipeline while it is in operation. Methane gas venting can also be mitigated by using hot tap connections, de-pressuring the pipeline to a nearby low pressure fuel system, or using a pipeline pump-down technique to route gas to sales. The EPA estimates that pipeline maintenance and upset conditions requiring venting result in emission of 19 Bcf of methane per year, a sizeable fraction of which can and should be captured.
- **Tank Vapor Recovery Units (VRUs)** capture methane that otherwise would escape from crude oil and condensate tanks and be vented to the atmosphere through three different mechanisms: (1) flashing losses, (2) working losses, and (3) standing losses. To reduce these losses, a vapor recovery unit can be installed on the tank to capture methane gas for sale or for use as fuel. The EPA estimates these methane emissions amount to about 21 Bcf/year, a sizeable fraction of which can and should be captured. In addition to methane, tank vapor recovery units can also reduce emissions of hazardous air pollutants (HAPs), such as benzene, toluene, ethylbenzene, xylenes, and volatile organic compounds (VOCs).
- **Leak Monitoring and Repair** prevents leaks at oil or natural gas facilities that would otherwise result in fugitive methane emissions, which may occur due to normal wear and tear, improper or incomplete assembly of components, inadequate material specifications, manufacturing defects, damage during installation or use, corrosion, or fouling. As gas moves through equipment under high pressure, methane gas leaks can occur from numerous locations at oil and gas facilities: valves, drains, pumps, threaded and flanged connections, pressure relief devices, open-ended valves and lines, and sample points. Because methane is a colorless, odorless gas, methane leaks often go unnoticed. Leak monitoring programs, and prompt repair when leaks are detected, can be effective in controlling fugitive emissions. Control can be achieved through a two-part process: (1) a monitoring program to identify leaks, and (2) a repair program to fix the leaks. The EPA estimates that equipment leaks result in gross emissions of 143 Bcf of methane per year. A large part of this may be controlled by improved leak monitoring and repair programs.

POLICY RECOMMENDATIONS

The EPA's *Greenhouse Gas Inventory* in recent years represents the agency's best current understanding of methane emissions from the O&G industry based on available data, recognizing that significant uncertainties exist. Changes to the inventory in recent years highlight challenges in understanding methane emissions from the O&G industry. NRDC calls upon the industry to provide improved data to aid the EPA in resolving uncertainties. NRDC strongly supports rigorous, mandatory reporting, especially from numerous small sources that in aggregate may result in significant emissions. Improved data can support more robust analyses of methane emissions, which will help with the development of appropriate emissions reduction solutions.

In its 2011 *Greenhouse Gas Inventory*, the EPA provides an excellent breakdown of emissions by both O&G sector (production, processing, transmission) and by source. It does not, however, provide enough detail of emissions reduction by leakage source. Emissions reduction is only identified at a broad sector level. NRDC recommends that the EPA provide a more detailed breakdown of emissions reduction by leakage source.

On broader policies to control methane emissions, NRDC supports the EPA's steps to improve the O&G industry proposed New Source Performance Standards (NSPS) to control VOCs, which will achieve significant methane reduction co-benefits.⁸ For example, methane emitted during well completions and recompletions will be controlled to a much larger extent once the proposed VOC regulations are implemented. The EPA's proposed NSPS regulations are a good starting point.

However, NRDC recommends that the EPA's proposed NSPS regulations go much further.⁹ First, the EPA should directly regulate methane. In addition, while the EPA has proposed federal performance standards for new and modified sources, the proposal does not cover the many existing sources of methane. The EPA should issue guidelines for existing sources, which states would then be required to adopt through their State Implementation Plans. The EPA's guidelines should cover all significant sources of emissions, and all segments of the natural gas supply chain, and require compliance with stronger standards and procedures.

While the Natural Gas STAR voluntary program has achieved some success in controlling methane emissions, mandatory control requirements such as under the NSPS and NESHAPs programs are necessary for greater industry-wide emissions reductions.

Federal land management agencies should also exercise their authority to control methane waste from oil and gas lease operations on federal lands.

Finally, state governments also can do more to require methane emission controls. Colorado, Montana, and Wyoming have rules covering existing methane emission sources including wells, pneumatic devices, and storage tanks. While these rules provide a good start, they and other states should develop even stronger regulations.

2. METHANE CONTROL: OPPORTUNITIES AND ISSUES

There is well established international scientific consensus, as demonstrated in the findings of the Intergovernmental Panel on Climate Change and the National Academy of Sciences, that greenhouse gas emissions are a significant cause of climate change. Methane gas is a well known and well-documented greenhouse gas, with a much greater global warming potential than carbon dioxide on a mass basis. Significant greenhouse gas emission controls, and methane emission control in particular, help to mitigate global warming.

Methane is the primary component of natural gas, which typically contains 80 to 90 percent methane, ranging up to as high as 98 percent in some cases.¹⁰ Every standard cubic foot (scf) of methane gas lost to the atmosphere is a standard cubic foot of methane not sold—a direct, real, and measurable loss of revenue. Methane control ensures that the gas produced at the well is kept in the revenue stream.¹¹

Not only are methane capture projects in the O&G industry critical for addressing the climate crisis, but such projects also can be profitable, improve safety, maximize energy resources, reduce economic waste, protect human health, and reduce environmental impacts. Furthermore, upgrading production assets with modern and efficient equipment

has improved operational and economic performance, making assets more robust and less susceptible to upsets and downtime.

Using a gas price of \$4/Mcf, based on average 2011 prices, every Bcf of methane captured and sold, rather than vented into the atmosphere, can generate approximately \$4 million in gross revenue. The EPA used \$4/Mcf as a conservative estimate in its 2011 NSPS proposed rulemaking (Figure 4). Many of the control technologies pay out their investment and start generating profits after a short period of time for the O&G industry, as well as those, including the U.S. government, who receive royalties and taxes on gas sales.

Figure 4: Current Average Gas Price \$4 Per Methane Cubic Square Feet

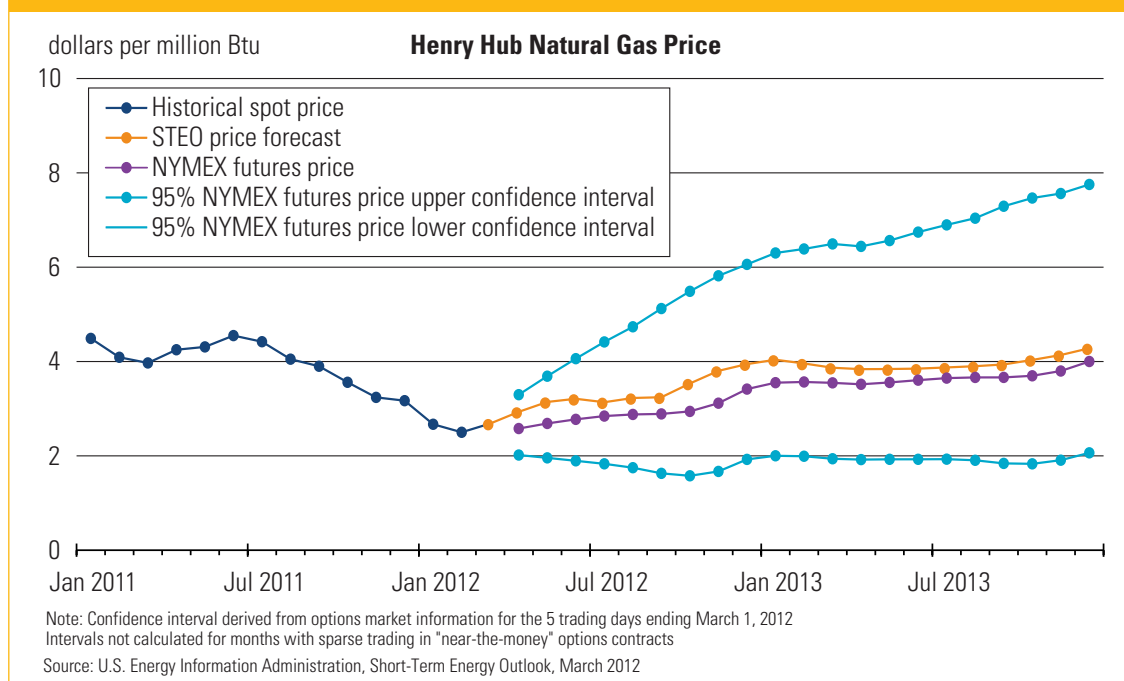
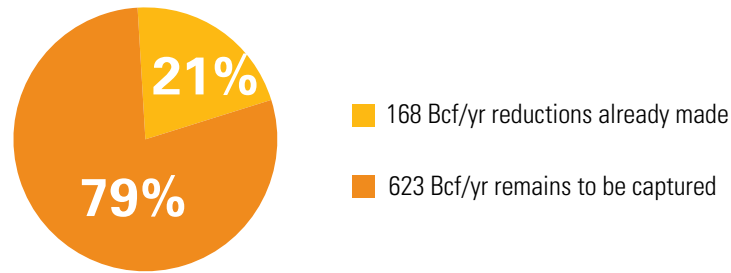

Figure 5: O&G Industry Methane Reduction and Remaining Opportunity



Source: U.S. EPA 2011 *Greenhouse Gas Inventory*

2.1 INCENTIVES TO INVEST

In light of the fact that methane controls have been shown to be profitable, a commonly asked question is: “Why doesn’t the O&G industry voluntarily invest in methane emission control?”

In some limited cases, site-specific factors, such as flow rate, temperature, and low gas pressure, make methane emissions control technically infeasible or unprofitable. However, for most of the methane control technologies highlighted in this report, it is simply a matter of modernizing outmoded business practices, commanding resource and budget allocations, and instilling a corporate commitment to greenhouse gas emission reduction.

The American Petroleum Institute (API) explains that in order to maximize profit and provide shareholders with the highest possible return on investment, the O&G industry operates with a strict ranking of capital projects for maximum yield.¹² Thus, even though methane control can be profitable, other core business projects with an even higher rate of return often compete successfully for available corporate funding. Payout periods for methane control technologies discussed in this report range from immediate to three years, yet this may not be attractive enough to compare with oil and gas companies’ high expected rates of return. In other cases, factors such as reserves booking (accounting for oil and assets on the balance sheet), and short- and long-term acquisition and divestment strategies can outweigh even high return, low capital methane reduction projects.

Obstacles to implementing even profitable methane control technologies—whether site-specific, financial, or institutional arising from company culture—may seem hard to overcome. But there is an especially compelling case for fixing market failures where limiting greenhouse gas emissions and profits go hand in hand. This is why NRDC finds that where companies do not adopt these technologies voluntarily, regulations requiring mandatory reductions should be implemented. For companies that lack the technical expertise or staff resources in house, there are excellent private and federal resources for technical assistance on methane control.

2.2 METHANE EMISSION TRACKING

In its 2011 *Greenhouse Gas Inventory*, the EPA estimated that the O&G sector emitted 623 Bcf of methane, with natural gas systems accounting for 547 Bcf and liquid petroleum systems contributing 76 Bcf. The EPA also estimated that the industry captured 168 Bcf of gross methane emissions in 2009, exclusively from natural gas systems.¹³ If no reductions were implemented, the gross leak rate would be an estimated 791 Bcf/year (623 Bcf/year net emissions plus 168 Bcf/year) as shown in Figure 5. The United States produces approximately 26,000 Bcf of natural gas per year. Thus, at the gross leak rate of 791 Bcf/year, the U.S. O&G industry is losing 3 percent of its total gas production to the atmosphere. At the EPA’s net leak rate of 623 Bcf/year, the industry is losing 2.4 percent of its total gas to the atmosphere.

As discussed in Section 2.3 below, the EPA numbers are quite uncertain. Other sources indicate that the amount of methane lost to the atmosphere each year in the United States could be substantially higher.¹⁴

According to the 2011 *Greenhouse Gas Inventory*, industry achieved the 168 Bcf in reductions through a combination of the EPA’s successful voluntary emission reduction program, Natural Gas STAR (77 percent), and federal emission regulations imposed on industry in the past decade to curb emissions (23 percent). The EPA did not identify any emission reductions achieved in the petroleum systems category. Most oil production operations also produce associated gas. Based on EPA estimates, there is a 76 Bcf methane reduction opportunity for the petroleum systems category.

The 2011 *Greenhouse Gas Inventory* tracks methane emissions by leakage source for natural gas systems (Figure 6) and liquid petroleum systems (Figure 7). In natural gas systems, methane emissions primarily come from wells, pneumatic controllers, compressors, and fugitive emissions. In liquid petroleum systems, methane emissions primarily come from equipment leaks, pneumatic controllers, and tank venting. Table 2 shows natural gas and liquid petroleum methane emissions in Bcf and identifies the applicable methane control technologies covered in this report.

A detailed breakdown of the methane emissions from both natural gas and liquid petroleum systems by source is shown in Appendix C.

Figure 6: Natural Gas System Methane Emission Sources

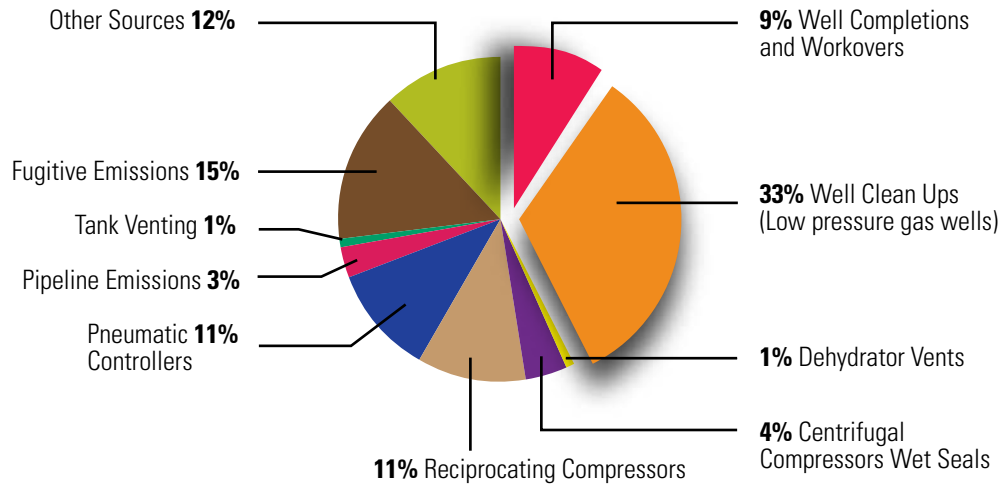

Note: 2009 total emissions 715 Bcf
Source: U.S. EPA 2011 *Greenhouse Gas Inventory*

Figure 7: Liquid Petroleum System Methane Emission Sources

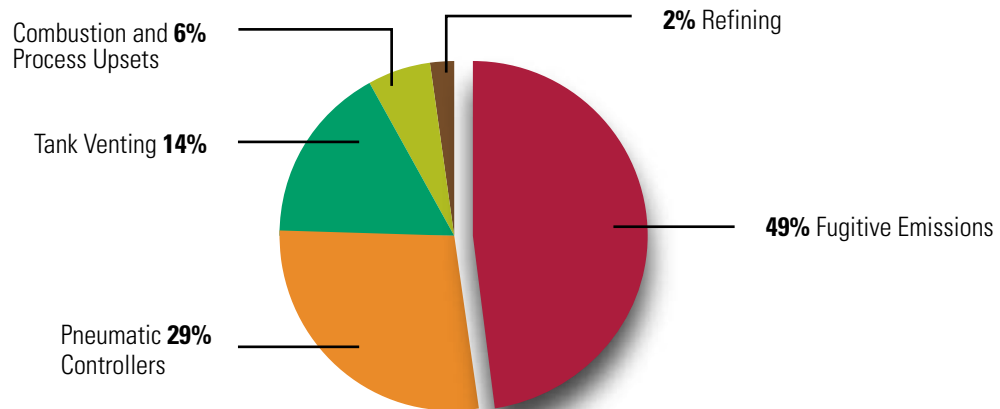

Note: 2009 total emissions 76 Bcf
Source: U.S. EPA 2011 *Greenhouse Gas Inventory*

Table 2: Methane Emission Sources and Control Technologies

2009 Natural Gas Systems		% of Total	Control Technologies
	Bcf	%	
Well Completions and Workovers	68	9%	No. 1 Green Completions
Well Clean Ups (Low pressure gas wells)	237	33%	No. 1 & 2 Green Completions & Plunger Lift Systems or Other Deliquification Methods
Dehydrator Vents	8	1%	No. 3 & 4 Dehydrator Controls
Centrifugal Compressors Wet Seals	27	4%	No. 5 Dry Seal Systems
Reciprocating Compressors	75	11%	No. 6 Improved Compressor Maintenance
Pneumatic Controllers	77	11%	No. 7 Low -Bleed or No-Bleed Controllers
Pipeline Emissions	19	3%	No. 8 Pipeline Maintenance and Repair
Tank Venting	10	1%	No. 9 Vapor Recovery Units
Fugitive Emissions	106	15%	No. 10 Leak Monitoring and Repair
Total of Emissions Controllable by the 10 Technologies	627	88%	
Other Sources	88	12%	
Total Emissions - Natural Gas	715	100%	
2009 Liquid Petroleum Systems		% of Total	Control Technologies
	Bcf	%	
Pneumatic Controllers	22	29%	No. 7 Low-Bleed or No-Bleed Controllers
Tank Venting	11	14%	No. 9 Vapor Recovery Units
Fugitive Emissions	37	49%	No. 10 Leak Monitoring and Repair
Total of Emissions Controllable by the 10 Technologies	70	92%	
Other Sources	6	8%	
Total Emissions - Liquid Petroleum	76	100%	

Source: U.S. Environmental Protection Agency Inventory of U.S. Greenhouse Gas Emissions and Sinks: 1990-2009.

2.3 UNCERTAINTY IN EMISSION ESTIMATES

The EPA has been tracking methane emissions since 1990. For more than 20 years, significant uncertainty has accompanied estimates of emissions from the O&G industry, with a general theme of underestimation. Some emissions have been underestimated by and for the O&G industry because sources have not been metered or tested to accurately determine the emission rate. Small emission sources that may result in cumulatively large emission totals have escaped emission monitoring or reporting, and not all emission sources are accounted for.

Evidence for underestimation due to uncertainty is found in the 2010 *Greenhouse Gas Inventory*, which states that “[n]atural gas well venting due to unconventional well completions and workovers, as well as conventional gas well blowdowns to unload liquids have already been identified as sources for which Natural Gas STAR reported reductions are significantly larger than the estimated inventory emissions.”¹⁵

Historically, the *Greenhouse Gas Inventory* was based on an emission factor of approximately 3,000 standard cubic feet (3 Mcf) per gas well drilled and completed.¹⁶ Yet Natural Gas STAR program partner experience shows several cases where emission factors were thousands of times higher:

- BP employed green completions at 106 wells and reported 3,300 Mcf of gas recovered per well¹⁷
- Devon Barnett Shale employed green completions at 1,798 wells between 2005 and 2008 and reported 6,300 Mcf of gas recovery per well¹⁸
- Williams employed green completions at 1,064 wells in the Piceance Basin and reported 23,000 Mcf of gas recovered per well¹⁹

All of these examples show gas recovery estimates more than 1,000 times higher than the 3 Mcf of gas per well estimated in the 2008 *Greenhouse Gas Inventory*.²⁰ Clearly, errors in emission inventory estimations have occurred.

Well completion emission estimates were underestimated by a factor of 1,000

The source of much of this uncertainty regarding well venting is the EPA’s historic reliance on a 1997 study jointly funded with the Gas Research Institute (GRI) to quantify methane emissions from United States natural gas operations.²¹ The study concluded that methane emitted (leaked and vented) from natural gas facilities at an amount of 1.4 percent +/- 0.5 percent (approximately 1 to 2 percent) of gross natural gas production, and that additional emission controls could significantly reduce the amount of methane gas leaked and vented to atmosphere.

However, the study did not include important equipment leaks and venting that took place at the wellhead or at the well pad processing facilities in natural gas systems.

The largest change in methane emission estimates has been in accounting for wellhead and well pad processing facilities emissions that were substantially underestimated.

Since 1990, the EPA has more than doubled its methane emission estimate for natural gas systems from 220 Bcf to 464 Bcf. For many years the EPA quoted a 300 to 400 Bcf/year methane emission estimate for the entire O&G industry, yet now the EPA reports a 322 to 464 Bcf range for natural gas production alone (Figure 8). While some of the methane emission increase is attributed to growth in natural gas production, most of the increase represents continuous improvement in and revisions to the EPA’s emission estimates as it furthers its understanding of methane emissions sources from the O&G industry. For instance, in past years emissions arising from poor connections from the wellhead to processing equipment to transmission equipment were overlooked. Low emissions from the distribution stage as a result of low-leakage welded joints may have contributed to a misconception that equipment upstream of the distribution stage was also similarly leak-free.

In 2010, the EPA undertook to develop a set of greenhouse gas reporting requirements for the O&G industry as part of a general charge from Congress to develop greenhouse gas reporting rules for all U.S. industries. The EPA assessed uncertainty in O&G emission estimates during this undertaking. The EPA explained the historic underestimation of natural gas systems, critiquing the “outdated and potentially understated” emissions estimates from the 1997 report.²² The EPA cited several significant sources of underestimated emissions:

The following emissions sources are believed to be significantly underestimated in the United States GHG Inventory: well venting for liquids unloading; gas well venting during well completions; gas well venting during well workovers; crude oil and condensate storage tanks; centrifugal compressor wet seal degassing venting; and flaring.

In its 2011 *Greenhouse Gas Inventory*, the EPA raised its gross emissions estimate to 791 Bcf/year by adding the amount of gas that may be vented at the wellhead to the amount of gas that leaks from the processing equipment and pipeline infrastructure once the gas enters the system.

According to the EPA’s O&G Reporting Rule Technical Support Document, the emissions estimates for these sources “do not correctly reflect the operational practices of today.” In fact, the EPA believes that “emissions from some sources may be much higher than currently reported in the United States GHG Inventory.”²³

The EPA revised emissions factors for four of these underestimated sources. Revised emissions estimates range from 11 times higher for well venting from liquids unloading, to 36 times higher for gas well venting from conventional well completions, to 3,540 and 8,800 times higher for gas well venting during well workovers and completions of unconventional wells, respectively.²⁴ Even with the EPA’s revisions to the O&G Reporting Rule, uncertainty continues to exist in the estimates of emissions from gas well completions and well workovers. As the EPA noted in the preamble to its proposed reporting rule:

Figure 8: O&G Industry Methane Emissions 1990 to 2009

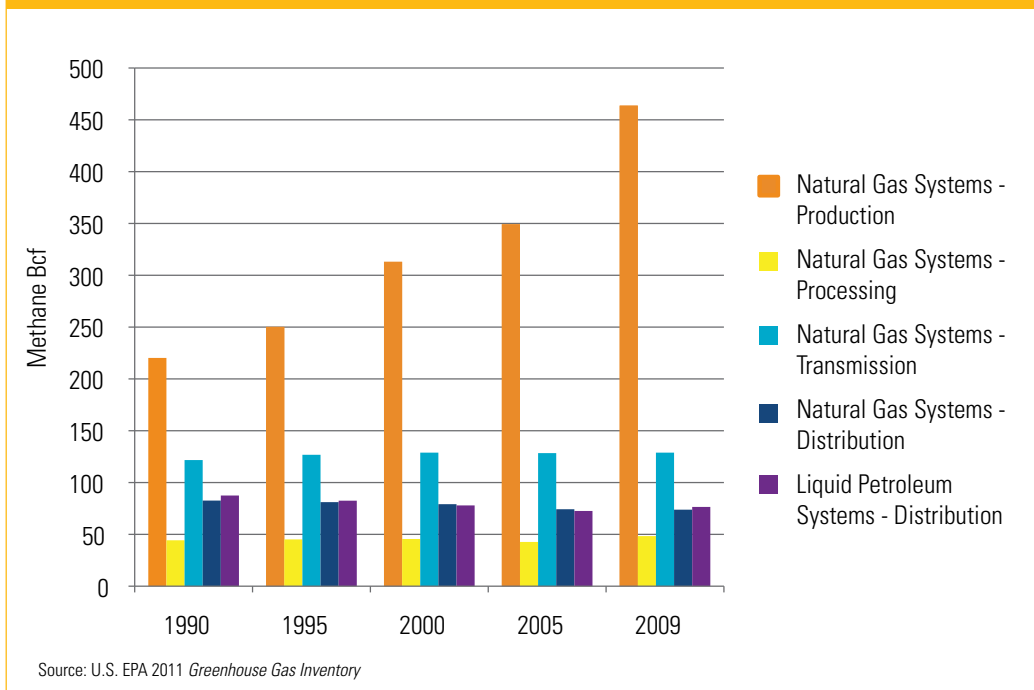

“[N]o body of data has been identified that can be summarized into generally applicable emissions factors to characterize emissions from these sources [(i.e., from well completion venting and well workover venting)] in each unique field. In fact, the emissions factor being used in the 2008 U.S. GHG Inventory is believed to significantly underestimate emissions based on industry experience as included in the EPA Natural Gas STAR Program publicly available information (<http://www.epa.gov/gasstar/>). In addition, the 2008 U.S. GHG Inventory emissions factor was developed prior to the boom in unconventional well drilling (1992) and in the absence of any field data and does not capture the diversity of well completion and workover operations or the variance in emissions that can be expected from different hydrocarbon reservoirs in the country.”²⁵

The EPA continues to report substantial uncertainty in its overall greenhouse gas emission estimates in its ongoing work on the *Greenhouse Gas Inventory*,²⁶ with uncertainty particularly evident for natural gas systems. In its 2011 *Greenhouse Gas Inventory*, the EPA used an average emission factor of 7,700 Mcf per well completion—much higher than its previous emissions factor of 3,000 Mcf per well completion—more than doubling the amount of emissions expected from the increasing number of unconventional well completions (e.g. horizontal and shale gas wells). Furthermore, the EPA did not include emissions from completions for tight gas wells in the 2011 *Greenhouse Gas Inventory*, which, as the EPA noted previously in its O&G Reporting Rule Technical Support Document, is a “significant underestimate” of total emissions.²⁷ The EPA also reported zero emissions from well completions in the Northeast

region, which is the location of extensive shale gas drilling and well completions in the Marcellus Shale.

Emissions estimates will likely continue to evolve and improve as the EPA obtains additional information from the O&G industry, including information submitted under its mandatory reporting rule. As with past inventories, it is expected that both emissions factors and activity factors will continue to be updated. If past trends hold, these factors are likely to be revised upward as a result of both better understanding of emissions associated with each process, and the aggressive pace of drilling and development across the country. However, emissions estimates for an individual source may also be revised downward as the EPA obtains better information about the type and amount of control technology in use.

Incidentally, the United States is not the only country that has struggled with estimating the O&G industry’s greenhouse gas emissions. Canada reports that its natural gas processing plants also discovered that methane emissions were roughly an order of magnitude higher than estimated.²⁸

Despite all the uncertainty about the precise amount of methane emissions, we do know that there is a significant amount of methane that is leaking or being vented into the atmosphere that could be captured and sold or used as fuel.

2.4 VOLUNTARY CONTROL WITH EPA NATURAL GAS STAR

For a number of years, the EPA has coordinated the Natural Gas STAR Program, which describes itself as a “flexible, voluntary partnership that encourages oil and natural gas

companies—both domestically and abroad—to adopt cost-effective technologies and practices that improve operational efficiency and reduce emissions of methane, a potent greenhouse gas and an important transitional energy source.”²⁹

To its credit, the EPA actively encourages O&G operators to invest in methane reduction technology through its Natural Gas STAR Program. Those members of the O&G industry that have recognized the adverse economic and environmental implications of methane emissions, and have voluntarily invested in greenhouse gas emission reduction technology at their facilities, also deserve credit.

While the Natural Gas STAR Program has been successful in identifying and documenting profitable methane emission reduction opportunities that aid in methane capture and in bringing captured methane into the revenue stream, to date the program remains voluntary and participation is limited.

Companies that participate in Natural Gas STAR sign a Memorandum of Understanding with the EPA, then evaluate and implement identified methane emission reduction opportunities. Companies can participate at any level they choose, from company-wide to site-specific to small pilot projects.³⁰ There is no mandatory requirement to identify or implement all methane reduction opportunities.

The extent to which enrolled companies participate is difficult to confirm. Natural Gas STAR publishes a list of participating companies, but all reports on the actual locations of emission control implementation, which methane control measures have been implemented by each company, and the emission reductions achieved, are confidential.

Despite these demonstrated solutions for capturing methane, many companies still have not participated in the Natural Gas STAR Program at all, and others have only implemented a few methane control measures.³¹ Effective as the EPA's Natural Gas STAR efforts have been, vast quantities of methane continue to leak into the atmosphere. It is therefore clear that voluntary measures alone will not ensure that industry installs even profitable capture technologies.

2.5 PROPOSED EPA RULES NOT STRONG ENOUGH

On August 23rd 2011, the EPA published proposed regulations for a suite of technologies to reduce harmful air pollution from the oil and natural gas industry.³² The rules are to be finalized by April 2012, after an opportunity for public comment.

The proposed EPA rules include NSPS for source categories as well as air toxics standards, or NESHAPs. In particular, the EPA is proposing stringent new NSPS for controls for VOCs from the oil and gas sector, which will also capture significant amounts of methane (referred to as “co-benefits” of the regulation).

The EPA estimates that the proposed NSPS for VOCs would reduce 540,000 tons of VOCs, an industry-wide reduction of 25 percent. The air toxics standards would reduce air toxics emissions by 30,000 tons, an overall reduction of nearly 30 percent.³³ The EPA estimates that the proposed standards would also reduce about 3.4 million tons per year of methane. This equates to roughly 160 Bcf/year. As an interim measure, the EPA quantified the global social benefits of these methane reductions in mitigating climate change at up to \$4.7 billion in 2015 co-benefits. For reasons set forth in NRDC's comments to the EPA on the proposed NSPS, we believe even this figure is a substantial underestimation.

Finally, the emissions baseline used in the EPA's proposed NSPS differs somewhat from the 791 Bcf/year gross emissions baseline in this report derived from the EPA's 2011 *Greenhouse Gas Inventory*. The differences reflect, among other things, the evolving nature of the emissions inventory. However, the differences do not meaningfully alter the analysis and recommendations made in this report.

The EPA's proposed standards do not control methane directly or cover existing sources, which account for the bulk of VOC and methane emissions. Further, the EPA omits other significant sources of VOCs and methane, in part due to exclusion of these sources altogether and in part because methane is not directly regulated. These omissions contrast with areas where the NSPS would in fact more effectively control emissions, such as from well completions and recompletions, and new sources of emission from pneumatic controllers, compressors, and equipment leaks.

This report does not provide a comprehensive assessment of the proposed NSPS, but the control technologies described here can serve as a guide to the EPA and the states in their control efforts.

Methane emissions reductions should be a high priority, as they provide economic, health, safety, and environmental benefits for both operators and the public. Existing market forces, government regulations, and voluntary programs are only leading to the capture of a small percentage of methane emissions at present. The EPA's proposed NSPS is a step in the right direction.

3. ANALYTIC APPROACH

While it would have been useful for the EPA to report the 168 Bcf emission reductions by leakage source, to clarify which sources and associated emissions reduction technologies are making progress in reducing emissions, that level of detail is not necessary to analyze the data and describe in layman’s terms why methane control technologies are profitable and point out large potential methane control opportunities.

Since the EPA does not provide sufficient data in its inventory to break down the emission reductions by natural gas leakage source, the methane emission estimates used in this report correspond to EPA’s emission estimate of 791 Bcf for natural gas and liquid petroleum systems.

This 791 Bcf estimate of gross emissions from both natural gas (715 Bcf) and petroleum (76 Bcf) systems has been reduced, the EPA reports, by 168 Bcf from Natural Gas STAR programs and regulations. All of these reductions have been achieved in natural gas systems. The total net emissions from both systems is therefore 623 Bcf (791 Bcf less 168 Bcf).

The total net emissions from natural gas systems is 547 Bcf (715 Bcf less 168 Bcf), and from petroleum systems it is 76 Bcf (Table 3). Additionally, it is important to note that the EPA’s Natural Gas STAR Program emission reduction estimates are based on data voluntarily submitted by industry. These data represent a very rough estimate of the amount of methane control that may have been achieved to date, because they were not developed using common and rigorous metering, measurement, quality control, or audit procedures. Therefore, some caution should be exercised in assuming that this amount of emissions reduction has been fully achieved.

Table 3: Methane Emission Control Opportunity						
2009 Natural Gas Systems		Natural Gas STAR Reductions	EPA Regulation Reductions	Total Reductions	Estimated Remaining Target	
	Gg	Bcf	Bcf	Bcf	Bcf	Bcf
Production	8,931	464	104	38	142	322
Processing	931	48	4	1	5	43
Transmission	2,482	129	19	0	19	110
Distribution	1,422	74	2	0	2	72
Total	13,766	715	129	39	168	547
2009 Liquid Petroleum Systems						
Production	1,444	75	0	0	0	75
Transmission	5	0	0	0	0	0
Refining	24	1	0	0	0	1
Total	1,473	76	0	0	0	76

Source: U.S. EPA 2011 *Greenhouse Gas Inventory*

*Slight rounding error accumulated in EPA tables. EPA records 715 Bcf and 168 Bcf as final estimates for 2009. Conversion: Gg/19.26=Bcf

3.1 PROFITABILITY

Profitable emission control opportunity, for purposes of this report, means an investment in methane emission control technology that results in more revenue generated or costs offset than the cost to install, operate, and maintain the emission control technology. To assist in identification of such opportunities, this analysis used the following criteria:

1. Control technology that either allows methane to be captured and placed into a natural gas pipeline for sale, or captured and used as fuel to offset operating cost
2. Technology that is commercially available, meaning that it has been developed, tested, and is available in the market for purchase and installation
3. Technology that has been used successfully in actual O&G operations
4. Emission control solutions that are well documented and reported by the O&G industry as profitable

The analysis recognizes that some emission reduction measures can be implemented quickly, while others may require more extensive planning, procurement, and execution timing.

Most of the emission control technologies described in this report have a very short payout period of a few months or years. The term “payout” means the period of time that it takes for the net cash flow to equal the investment expenditure, at which point the investment breaks even and starts to generate positive cash flow, as shown in Figure 9.³⁴ The revenue stream is calculated using constant dollars over the payout period.³⁵

3.2 EXAMINATION OF METHANE CONTROL OPTIONS

Each of the 10 methane control options examined in this report is considered with a six-part analysis.

1. **Technology Description.** The technology description section identifies the equipment required and processes used in each control technology to capture methane emissions.
2. **Opportunity.** The opportunity section identifies the gross amount of methane emissions in the 2011 *Greenhouse Gas Inventory* that could be captured by each control technology for its associated leakage source.
The per-unit emission estimates provided in the opportunity section of the report are intended to provide an average emission control number, to use as a starting basis in a feasibility assessment. Individual consideration may be appropriate based on unique or exceptional circumstances at each site.
3. **EPA Proposed Regulations.** This section analyzes the proposed regulations from the EPA that are relevant to emissions from each source. It also discusses the emission reductions anticipated from the proposed EPA regulations, and concludes with a description of possible shortcomings of and improvements to the EPA proposal.

Figure 9: Payout Period Diagram

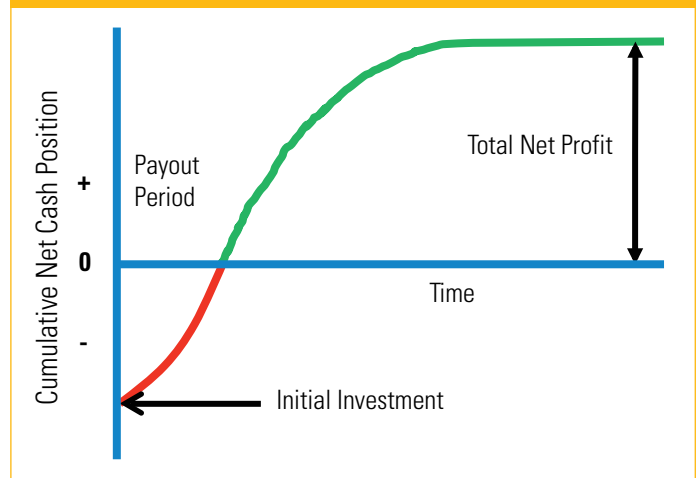

4. **Profit.** The profit section analyzes the costs of implementing each technology, along with any associated operational savings and revenues from methane sales. The revenues are calculated by multiplying the amount of methane controlled by a price of \$4/Mcf. The report does not attempt to quantify the additional financial benefits from offsetting fuel costs. Comparing the costs with the savings and additional revenues provides the profit. The average payout period is also calculated using these numbers. The cost data are intended to provide an average cost to use as a starting basis in a feasibility assessment. Again, individual consideration may be appropriate based on the particulars of a given application.

The proposed EPA regulations provide some estimates of the profitability of the various control technologies. However, in the supporting documentation for the proposed rulemaking, the EPA was not transparent enough about its methodology for cost-benefit estimates.³⁶ As a result, we were unable to independently verify sources and incorporate them into profitability estimates. Instead, we have relied on estimates from prior EPA and company reports. For the sake of completeness, in the appendix we provide tables of profitability estimates by control technology from this report, and compare them with the EPA estimates from the proposed rulemaking supporting documentation. In general, the EPA's proposed rulemaking estimates are somewhat more conservative than NRDC estimates. A more detailed analysis of NRDC's profitability comparisons can be found in the EPA's rulemaking docket.³⁷

5. **Additional Benefits.** Beyond generating revenue, the additional benefits of methane capture for each technology are highlighted in this section.
6. **Limitations and Evaluation.** All emission control options have some technological (and, potentially, economic) limitations, and where those are known, they are summarized in this section for use as a starting

point in a feasibility assessment. In some cases, a certain emission control technology may not be suitable because it cannot handle a gas flow rate, temperature, or pressure. In other cases, the technology may not be appropriate for a retrofit, but would be a logical choice for designing and installing a new unit. This section includes flow charts to depict the basic decision steps of a feasibility analysis. The flow charts are intended to be simplistic outlines of the steps that might be taken to determine the feasibility of using a particular emission control method. This simplified approach is not intended to replace any company-specific evaluation processes, but rather to provide a basic outline of the evaluation steps in laymen's terms.

3.3. METHANE EMISSION REPORTING UNITS

While greenhouse gas emission estimates are often reported in terms of million metric tons of carbon dioxide equivalent (MMtCO₂e), all methane emission and methane control estimates in this report are shown in terms of standard cubic feet, and most often reported in billions of standard cubic feet (Bcf). The report uses this emission reporting convention because gas is sold and used on a basis of standard cubic feet, and this unit can readily be converted to a profit estimate using a market price assumption of four dollars per thousand standard cubic feet (\$4/Mcf). This reporting convention prevents the reader from having to routinely convert from MMtCO₂e to Bcf.

4. TEN PROFITABLE TECHNOLOGIES: AN ANALYSIS

The emission control potential, uses, benefits, and economics of each of the 10 methane control technologies are discussed in greater detail in this chapter. While many of the technologies are profitable on a very short time scale, many operators still have not installed them. In order to realize the methane control potential to limit greenhouse gas emissions, NRDC also proposes policy options to encourage the use of these technologies.

Table 4: Methane Capture Technology Costs and Benefits

Technology	Investment Cost	Methane Capture	Profit	Payout
Green Completions	\$8,700 to \$33,000 per well	7,000 to 23,000 Mcf/well	\$28,000 to \$90,000 per well	< 0.5 – 1 year
Plunger Lift Systems	\$2,600 to \$13,000 per well	600 to 18,250 Mcf/year	\$2,000 to \$103,000 per year	< 1 year
TEG Dehydrator Emission Controls	Up to \$13,000 for 4 controls	3,600 to 35,000 Mcf/year	\$14,000 to \$138,000 per year	< 0.5 years
Desiccant Dehydrators	\$16,000 per device	1,000 Mcf/year	\$6,000 per year	< 3 years
Dry Seal Systems	\$90,000 to \$324,000 per device	18,000 to 100,000 Mcf/year	\$280,000 to \$520,000 per year	0.5 – 1.5 years
Improved Compressor Maintenance	\$1,200 to \$1,600 per rod packing	850 Mcf/year per rod packing	\$3,500 per year	0.5 years
Pneumatic Controllers Low-Bleed	\$175 to \$350 per device	125 to 300 Mcf/year	\$500 to \$1,900 per year	< 0.5 – 1 year
Pneumatic Controllers No-Bleed	\$10,000 to \$60,000 per device	5,400 to 20,000 Mcf/year	\$14,000 to \$62,000 per year	< 2 years
Pipeline Maintenance and Repair	Varies widely	Varies widely but significant	Varies widely by significant	< 1 year
Vapor Recovery Units	\$36,000 to \$104,000 per device	5,000 to 91,000 Mcf/year	\$4,000 to \$348,000 per year	1 – 3 years
Leak Monitoring and Repair	\$26,000 to \$59,000 per facility	30,000 to 87,000 Mcf/year	\$117,000 to \$314,000 per facility per year	< 0.5 years

Note: Profit includes revenue from deployment of technology plus any O&M savings or costs, but excludes depreciation. Additional details provided in Appendix A.
Source: NRDC analysis of available industry information. Individual technology information sources cited in Chapter 4.

4.1 GREEN COMPLETIONS

Methane gas is often released into the atmosphere when natural gas or oil wells are drilled, stimulated (e.g. hydraulically fractured), or repaired. Green completions can be used to capture methane gas and gas liquids (condensate).³⁸ Rather than being vented or flared into the atmosphere, methane captured in a green completion can be sold, used as fuel, or re-injected to improve well performance. Green completions also capture gas liquids that can be sold.

This technology is also called reduced emission completions, or REC, but throughout this report we use the term “green completions.”

When a well is drilled and completed, stimulated, or repaired, it is standard procedure to flow the well for a period of time to remove stimulation materials and other debris from the wellbore. This procedure is called “wellbore cleanup” and occurs before connecting the well to permanent processing equipment. Wellbore cleanup allows the operator to remove and dispose of unwanted material

without contaminating production facilities and pipelines. It also improves well recovery rates by reducing wellbore formation damage downhole. Historically, wells were “cleaned up” flowing liquid hydrocarbons to an open pit or tank, and by routing the associated methane gas to a gas vent or flare (Figure 10).

Venting gas near well operations creates potentially explosive vapor levels and can pose a human health hazard. Flaring resolves much of the explosive vapor problem by routing gas away from the well operations to a flare stack that burns the gas at a distance from the well and associated facilities, but flaring creates economic waste by combusting gas that could otherwise be collected and sold. Flaring also varies in efficiency, so not all pollutants may be combusted, and also generates air, light, and noise pollution.

4.1.1 Technology Description

In a green completion, the operator brings temporary processing equipment to a well site during wellbore cleanup. Well cleanup fluids and gases are routed to the temporary processing equipment. Fluids, debris, and gas are separated, and gas and condensate are recovered for sale. The temporary processing equipment required for a green completion typically includes gas-liquid-sand separator traps, portable separators, portable gas dehydration units, additional tanks, and, sometimes, small compressors. A simplified schematic showing the equipment required for a green completion is shown in Figure 11.

Green completion processing equipment, which provides temporary gas processing capability, is typically mounted on a truck or trailer to move it from well to well (Figure 12).



© Robert Doman

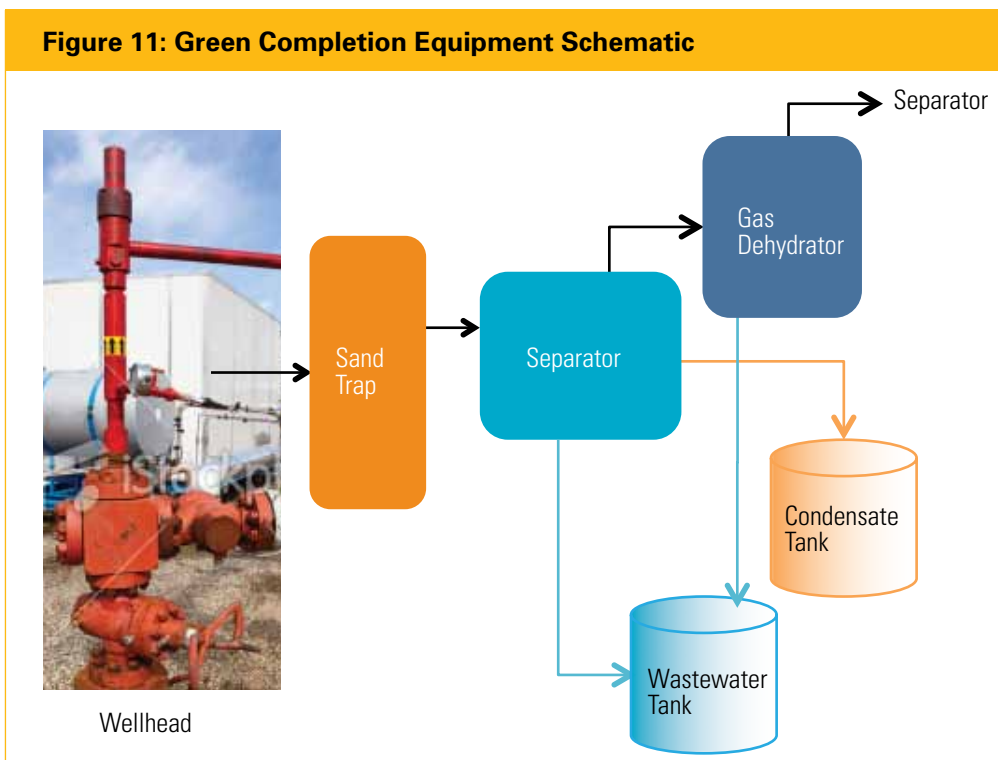

Figure 12: Green Completion Equipment



Colorado Oil & Gas Conservation Commission, "Proposed Rules for Green Completions" presentation June 27, 2008

Portable green completion units are either owned by the operator or rented from a service provider. For new wells, equipment may need to be brought to the well site to provide temporary gas processing capability. However, at existing well sites, where wells have already been drilled but may need to be repaired or stimulated to improve hydrocarbon production rates, gas processing equipment may already be available onsite.

While the processing equipment is portable, some permanent facility infrastructure must be in place at the well site to make a green completion possible. Gas collected from a green completion can be used in several ways. It can be sold in a pipeline, used as fuel at the well site, or used as gas lift to enhance hydrocarbon production in low pressure wells. Each of these uses requires piping infrastructure to be in place at the well site to route the gas to the appropriate destination. Therefore, a green completion is typically not an option for exploration wells with no offset wells or pipeline infrastructure nearby.

The EPA estimates that an average of 8,200 Mcf can be recovered per green completion

Typically, gas produced from a well contains liquid ("wet gas") that exceeds the acceptable moisture content allowed in a gas sales pipeline. Depending on the gas composition, hydrocarbons may also condense from a gas to a liquid under certain temperature and pressure conditions. The pressure drop from the wellhead through the gas processing equipment can also yield gas-liquids (condensate) that can be captured and sold. Therefore, in most cases, before

gas from a green completion can be routed to a gas sales pipeline, it must be dehydrated to remove liquids to meet the gas pipeline specifications. Gas dehydration can be accomplished by bringing in a portable gas dehydration unit, or using a permanent gas dehydrator installed upstream of a gas pipeline. Condensate can either be collected in a temporary stock tank, or routed to a permanent stock tank if one is located on site.

4.1.2 Opportunity

Reduction Target: 68 Bcf/year and a portion of 237 Bcf/year

The 2011 *Greenhouse Gas Inventory* estimates that well completions, workovers, and well cleanups emit approximately 305 Bcf of methane annually, 43 percent of total natural gas systems methane emissions.³⁹ Of this amount, well completions and workovers contributed about 68 Bcf/year, and well cleanups contributed about 237 Bcf/year, as shown in Table 2. Green completions may be used to control a significant fraction of emissions from well completions and workovers. Green completions can also be used to control a portion of the emissions from well cleanups, also known as liquids unloading.

There remains considerable uncertainty in wellhead emissions. In the decade prior to the 2011 *Greenhouse Gas Inventory*, the EPA revised its well emission estimates upward several times, and it reports continued uncertainty in the 2011 inventory estimates. It is likely that well methane emissions are still underestimated.

Green completions alone could enable the United States to achieve more than 30 percent of its O&G industry methane reduction opportunity

In 2005, the EPA estimated that an average of 7,000 Mcf of natural gas can be recovered during each green completion.⁴⁰ In 2011, the EPA increased its reduction estimate to 8,200 Mcf per green completion.⁴¹ As part of its analyses relating to Subpart W of the Greenhouse Gas Reporting Rule, the EPA calculated the average emissions reduction to be 9,175 Mcf per green completion.⁴² In a 2011 *Lessons Learned* report, the EPA estimated that an average of 10,800 Mcf could be saved per green completion.⁴³

The EPA has found that green completions can be a major contributor to methane reductions on a national scale. In 2008, the EPA's Natural Gas STAR Program attributed 50 percent of the program's total reductions for the O&G production sector to green completions.⁴⁴ Considering the promising technical and economic feasibility of green completions, a very large fraction of the emissions from

well completions and workovers, and a portion of the emissions from well cleanups, could be captured using green completions.

The commercial viability of green completion equipment has been so well demonstrated that it is now required in several states:

- Colorado requires green completions on all oil and gas wells unless it is not technically and economically feasible.⁴⁵
- Fort Worth, Texas requires green completions for all wells that have a sales line nearby, and for wells that are shut-in while gas is conserved, unless the operator can show that this requirement would endanger the safety of personnel or the public.⁴⁶
- Montana requires VOC vapors (including methane) greater than 500 British Thermal Units (BTUs) per cubic foot from wellhead equipment with the potential to emit 15 tons per year or greater, to be routed to a control device (such as a flare), or to a pipeline for sale.⁴⁷
- Wyoming has required green completions in the Jonah-Pinedale Anticline Development Area (JPAD) since 2007. More recently, Wyoming has expanded this requirement to all Concentrated Development Areas of oil and gas in the state.⁴⁸

Such rules mandating green completions are an excellent method to help reduce emissions of greenhouse gases and toxic air pollutants, and exceptions written into these rules allowing operators not to use green completion technology should be very narrow, limited to only when it is proven to be unsafe or technically infeasible.

The API reports that there are only 300 green completion units in operation in the United States with the ability to complete 4,000 wells per year.⁴⁹ This corroborates the upper end of the EPA's estimate that the U.S. O&G industry has a capacity to implement approximately 3,000 to 4,000 green completions per year.⁵⁰

While some operators report use of green completions at a portion of their operations in the United States, it is clear that opportunities abound for much wider deployment of green completions to reduce methane emissions. The API estimates that only 20 percent of U.S. gas well emissions are currently being captured by green completions and that an additional 16,000 wells per year could be processed if there were sufficient green completion equipment capacity.

4.1.3 Proposed EPA Regulations

The EPA is proposing to require green completions to control emissions from all production wells that undergo a hydraulic fracture treatment. The EPA proposes to exempt exploration wells and all other gas wells that are not hydraulically fractured.

Therefore, the EPA expects that more than 95 percent of emissions from well completions and workovers would be controlled using green completions. NRDC applauds the EPA's proposed regulations for targeting significant emissions

reductions during well completions and recompletions. Still, green completions should be required for all wells where technically feasible, including well cleanups and wells that are not hydraulically fractured. Such a requirement can be expected to lead to the rapid increase in availability of green completion equipment.

4.1.4 Profit

Green completions provide an immediate revenue stream by routing to a gas sales line gas (methane and condensates) which would otherwise be vented into the atmosphere or flared. Alternatively, captured gas can be used for fuel, offsetting operating costs or be re-injected to improve well performance. Industry has demonstrated that green completions are both an environmental best practice and profitable.

For each unconventional gas well green completion, there is an opportunity to generate about \$28,000 to \$90,000 in profit, based on capture rates of 7,000 to 23,000 Mcf per well, as shown in additional detail in Appendix A, Table A1. The EPA currently estimates the cost of implementing a green completion as high as \$33,000 (for rented equipment).^{51,52} Based on these and other estimates, green completions using rented equipment will typically pay out immediately while those with purchased equipment will pay out within a year.⁵³ NRDC recognizes wells currently chosen for green completions are likely to be more productive and therefore profitable than average wells going forward.

Operators with a sufficient number of wells to amortize the cost of the equipment are finding it economically attractive to invest in their own green completion technology rather than to rent equipment. Most companies that have gone this route report a one- to- two year payout for investment in purchasing green completion equipment, and substantial profitability thereafter.⁵⁴

Smaller operators can rent green completion equipment from a contractor. Renting equipment will result in a lower profit margin because there is usually a slightly higher operating cost attributed to equipment rental versus equipment ownership. Still, the payout for this investment would occur quickly if a contractor was hired and the operator paid only a per well green completion equipment rental charge. As long as the gas captured and sold exceeded the equipment rental charge, payout would be immediate.

In a 2009 study conducted for New York State, ICF Incorporated found that equipment payouts may be as short as three months. ICF also found that companies electing to conduct green completions in 2005 made more than \$65 million in profits.⁵⁵

Examples listed below demonstrate how profitable green completions can be. The data is provided in the form reported by each company. However, these examples show that green completions are profitable, and generally pay out in less than two years:

- In 2004, Devon Energy reported an average incremental cost to perform a green completion of \$8,700 per well at its Texas Fort Worth Basin operations. Devon estimated that it made a profit of \$50,000 per well by selling the captured gas to market and achieved a total emission reduction of 6.16 Bcf at its operations in year 2005. 78 percent of the methane captured (4.8 Bcf) was attributed to green completion methods.^{56,57}
- BP reported an initial investment cost of \$1.4 million to purchase a portable three-phase separator, sand trap, and tanks to conduct green completions. By 2005, BP completed 106 wells using this equipment and reported an average gas recovery of 0.35 Bcf per year, and condensate recovery of 6,700 barrels per year. The company's investment paid out in less than two years. Thereafter, the equipment brought in a profit of at least \$840,000 per year.⁵⁸ In 2007, BP reported that green completions had netted a profit of \$3.4 million on an investment of \$1.2 million, with a payout of 0.7 years, and a capture of 130 Mt of methane per well.⁵⁹
- Williams reported \$159 million in revenue from green completions in its Colorado Piceance Basin Operations from 2002 to 2006, on an investment of \$17 million, for a net profit of \$142 million.⁶⁰ Williams' data was based on 1,177 wells and an average gas recovery of approximately 91 percent.
- EnCana Corporation, the largest natural gas producer in North America, which produces 1.5 percent of United States daily gas needs, reported that green completion methods were extremely profitable in the Jonah Field in Wyoming, yielding a net present value (NPV) of more than \$190 million.⁶¹ EnCana's initial investment in the portable green completion equipment for the Jonah Field paid out in the first year.
- Anadarko reported an increased operating profit of \$10.3 million per year for the period 2006 to 2008 due to green completions on an average of 613 wells per year.⁶²

4.1.5 Additional Benefits

Green completions provide a number of additional benefits, aside from profitability and methane emission reductions. Green completions:

- Collect potentially explosive gas vapors, rather than venting them into the atmosphere (improves well site safety, reduces worker exposure to harmful vapors, and limits overall corporate liability)
- Reduce or eliminate the need for flaring
- Reduce emissions, noises, odors, and citizen complaints associated with venting or flaring

- Reduce VOCs and HAPs contained in natural gas along with methane. If flared and not captured, VOCs and HAPs generate nitrogen oxides (NO_x) and particulate matter (PM), contributors to ground-level ozone and regional haze
- Improve well cleanup and enhance well productivity, as wells flow back to portable separation units for longer periods than would be allowed with direct venting into the atmosphere or flaring
- Reduce the need to drill new wells as more methane is kept in the system and brought to market

4.1.6 Limitations and Evaluation

Green completions are most successful and profitable on higher pressure wells that have sufficient gas reservoir pressure to both flow into a pressurized gas sales pipeline and adequately clean up the wellbore.⁶³

For lower pressure wells, artificial lift may be required, using portable compressors to withdraw gas from a pressurized sales gas line. The pressurized gas is then injected into the well to unload wellbore liquids and solids (artificial lift), and initiate flow. Compressors may also be needed to boost the lower pressure gas back into the sales line until normal reservoir flow and pressure is established.⁶⁴ Adding compression to the equipment package required for a green completion will increase cost.

Recognizing the existence of technical limits, Colorado sets boundaries on when green completions should be required:

"Green completion practices are required on oil and gas wells where reservoir pressure, formation productivity, and wellbore conditions are likely to enable the well to be capable of naturally flowing hydrocarbon gas in flammable or greater concentrations at a stabilized rate in excess of five hundred (500) MCFD to the surface against an induced surface backpressure of five hundred (500) psig or sales line pressure, whichever is greater. Green completion practices are not required for exploratory wells, where the wells are not sufficiently proximate to sales lines, or where green completion practices are otherwise not technically and economically feasible.

An operator may request a variance from the Director if it believes that employing green completion practices is not feasible because of well or field conditions or that following them in a specific instance would endanger the safety of well site personnel or the public."⁶⁵

In the event that Colorado issues a variance from using green completion techniques due to technical or safety constraints, it still requires the use of Best Management Practices to minimize the amount of methane emitted:

"In instances where green completion practices are not technically feasible or are not required, operators shall employ Best Management Practices to reduce emissions. Such BMPs may include measures or actions, considering safety, to minimize the time period during which gases are emitted directly to the atmosphere, or monitoring and recording the volume and time period of such emissions."

Because pipelines are typically not installed at a natural gas production site until it is confirmed that an economical gas supply is found, gas from the first well is often flared or vented during drilling and completion activities. However, once a pipeline is installed, subsequent wells drilled on that same pad would be in a position to implement green completion techniques. Operators often point to the lack of pipeline infrastructure as a primary reason a green completion may not be possible, in particular at oil production facilities that do not have a nearby gas sales line. However, there are also alternatives to piping methane, such as using it on-site to generate power, re-injecting it to improve well performance, or providing it to local residents as an affordable power supply.

Figure 13 provides a simplified flowchart showing the basic steps for evaluating whether a green completion is technically feasible and profitable.

4.2 PLUNGER LIFT SYSTEMS

Older gas wells stop flowing when liquids (water and condensate) accumulate inside the wellbore. As liquid builds up in the wellbore it creates backpressure on the hydrocarbon formation, further reducing the gas flow rate.

Methane gas is emitted when companies open wells to vent gas to the atmosphere to unload wellbore liquids (water and condensate that accumulate in the bottom of the well) in order to resume gas flow. The industry typically refers to this process as “blowing down the well,” a “well blowdown,” or a “well deliquification.”

Eventually, even a well’s own gas pressure becomes insufficient to flow accumulated liquids to the surface and the well is either shut-in as uneconomic, or some form of artificial lift is installed to transport the liquids to the surface.

Plunger lift systems are one method of lifting accumulated liquids in the wellbore to the surface. In this method, methane gas can be captured and sold, rather than vented to atmosphere as waste.

4.2.1 Technology Description

Installation of plunger lift systems provides an immediate revenue stream by routing methane gas to a gas sales line that would otherwise be vented. Industry has demonstrated that plunger lift systems are both an environmental best practice and profitable when addressing mature gas wells with back pressure from liquids.

Accumulation of liquid hydrocarbons and liquids in the well tubing of mature gas wells can halt or impede gas production. Historically, well operators would vent these mature gas wells to atmosphere to aid in expelling the liquids from the well tubing. Alternatively, plunger lift systems can be installed in a well to lift the liquids out of the well (Figure 14).

There are a number of deliquification methods that can be used on a mature gas well singly or in combination, such as sucker rod pumps, electric submersible pumps, progressing cavity pumps, compression, swabbing, gas lift, and smaller diameter tubing (velocity strings), but most of these methods require the addition of energy.⁶⁶ The plunger lift system is a low-cost system that uses the well’s own natural energy to complete the deliquification process. This technology is particularly useful at well sites that do not have power.

Plunger lift systems work by using the natural gas pressure that builds up in the casing tubing annulus to push a metal plunger up the well tubing, forcing a column of fluid to the surface. Gas and liquids are both collected. Liquids are separated from the gas, which is then routed to the pipeline for sale.

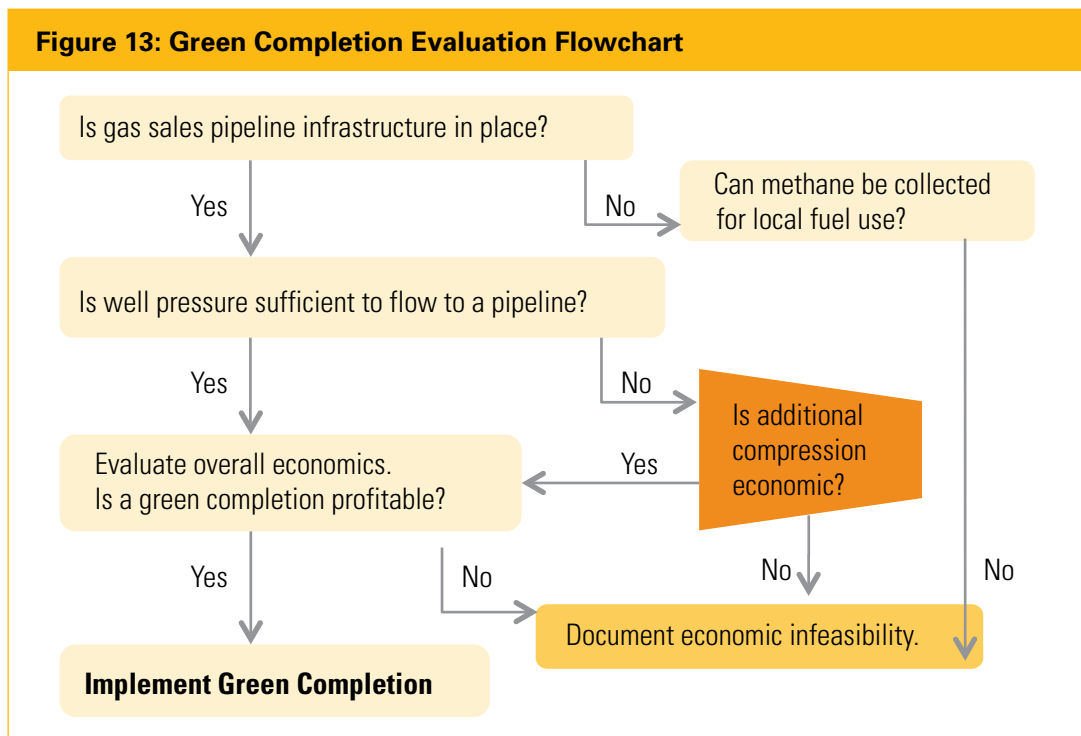
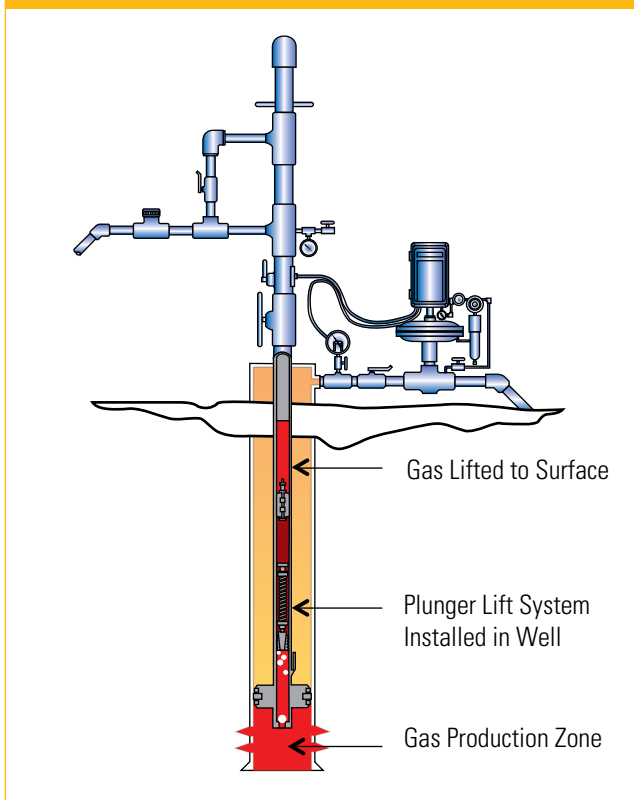

Figure 14: Plunger Lift System Schematic



Automated plunger lift systems have the added benefit of reducing the number of personnel that would be required to manually vent the well and extending the production life of the well.⁶⁷

One vendor reports that plunger lift systems increase overall gas productivity and sales from each well by 10 to 20 percent.⁶⁸

4.2.2 Opportunity

Reduction Target: 237 Bcf/year Less Green Completions Reduction

Natural gas production is now predominantly occurring in unconventional formations: low permeability sands, shale, and coal bed methane reservoirs.⁶⁹ In its comments on the EPA's proposed NSPS regulations for plunger lift systems, the American Petroleum Institute said: "According to the Energy Information Administration...some 338,056 (73 percent) wells out of a total gas well inventory of 461,388 produce 90 Mcf of gas (15 BOE or less) or less per day...These low rate wells are either impaired by liquids accumulation or are using a deliquification method to produce."⁷⁰

Maximizing production from each well drilled can minimize the need to drill new wells and therefore reduce overall environmental impacts from natural gas production. However, low gas rate wells eventually cease production due to liquid accumulation in the wellbore and are often shut-in,

unless a deliquification technique is employed on the well.

The EPA estimates that 4,700 to 18,250 Mcf/year of methane gas can be recovered per well with plunger lift systems.^{70,71} In 2011, the EPA estimated that 237 Bcf of methane was emitted from well cleanups annually. A large fraction of these emissions could be controlled using plunger lift systems.

Plunger lift systems are low cost and use a well's own natural energy

4.2.3 Proposed EPA Regulations

The EPA's proposed NSPS regulations would not require the use of plunger lift systems to address well cleanups. Even if plunger lifts are more widely used than previously assumed, we strongly recommend that the EPA revise its proposal to require plunger lift systems to ensure that such systems are in use at all feasible sites.

NRDC acknowledges that there are many options for well deliquification. In any case, there is a methane control target (237 Bcf) that should be addressed by plunger lifts or other well deliquification methods that capture methane with similar efficiency and effectiveness. NRDC recommends that, while operators should have flexibility in selecting among the options, the basis for selection should be minimizing methane emissions.

4.2.4 Profit

Installing a plunger lift system in a gas well involves a small initial investment, estimated by the EPA to be between \$2,600 and \$10,400 per well.⁷² Plunger lift system maintenance may cost about \$1,300 per year, but yields other operational savings such as avoided chemical treatment of about \$13,200 per year, resulting in a net savings.

Each plunger lift installed in an older gas well could result in 600 to 18,250 Mcf per year of recovered gas, valued at \$2,000 to \$103,000, when operations and maintenance savings are included. The value of methane gas recovered and sold rapidly covers that initial investment cost, as shown in greater detail in Appendix A, Table A2.

Most companies report a less than one-year payout and substantial profit thereafter, depending on the gas recovery rate. Future profits will be offset eventually by declines in gas recovery rates, and by minimal additional operating and maintenance costs, but since most plunger lift systems pay back in less than a year, plunger lift installations typically start profitable and remain profitable for many years after the initial investment.

The examples below, reported by industry, illustrate the profitability of plunger lift systems:

- Between 1995 and 1997, Mobil Oil installed plunger lifts in 19 wells at its Big Piney Field in Wyoming, reducing its emissions by 12,166 Mcf per year.⁷³

- In 2000, BP installed plunger lift systems with automated controls on approximately 2,200 wells in the United States, and reported a 50 percent reduction in gas well blowdowns for liquid unloading by year 2004.⁷⁴ By 2006, BP reported the installation of “smarter” plunger lift automation systems, achieving a \$15.5 million per year profit on an average annual recovery of 1,424 Mcf of methane gas per well.⁷⁵
- In 2000, Conoco reported that installation of plunger lift systems in its low-pressure gas wells in Lea County, New Mexico reduced operating costs by more than 70 percent.⁷⁶
- In 2006, Amoco reported that it installed plunger lifts at a cost of \$13,000 per well at its Midland Texas field, resulting in electricity, well workover, and chemical treatment savings of \$24,000 per year per well. In addition there was a small increase in gas production, which added about an additional \$79,000 in profit to each well per year, for a total benefit of more than \$100,000 per well.⁷⁷
- In 2007, Devon Energy reported a 1.2 Bcf reduction of vented methane gas in its operations due to installation of plunger lift systems.⁷⁸
- In 2010, the New Mexico Oil and Gas Association submitted testimony to the New Mexico Environmental Improvement Board confirming that plunger lift systems have been technically viable and economically attractive in the San Juan Basin.⁷⁹

4.2.5 Additional Benefits

Automated plunger lift systems continuously optimize gas production. Regular fluid removal limits the periods of time that liquid loading “kills” the well and halts gas production.

The mechanical action of the plunger traveling up and down the tubing also prevents buildup of scale and paraffin

in the tubing. Preventing excess scale and paraffin buildup reduces the cost of the chemical or mechanical swabbing treatments required to remove this buildup, and, in more serious cases, the cost of well workovers. The EPA reports additional savings associated with plunger lift systems ranging from \$6,600 to \$14,500 per well for reduced chemical treatment and workover costs.⁸⁰

Gas venting near well operations creates potentially explosive vapor levels that can pose a human health hazard. Collection of potentially explosive gas vapors, rather than venting the gas to atmosphere, improves well site safety, reduces worker exposure to harmful vapors, and limits overall corporate liability.

Additionally, gas capture and sale reduces emissions, noises, odors, and citizen complaints associated with venting.

Unprocessed natural gas contains VOCs and HAPs, along with methane. Therefore, capture of this gas also reduces VOCs and HAPs pollution.

4.2.6 Limitations and Evaluation

Plunger lift systems are useful in gas wells that tend to fill with liquid, and have sufficient gas volume and pressure to power the plunger lift system. Such factors should be taken into account in determining applicability. In some cases, wells installed with plunger lifts may need to be vented for a short period of time to generate the differential pressure needed to resume well liquid removal. Even in this case, total methane emissions are substantially reduced. Also, a plunger cannot be run in a well bore with changing tube sizes, or wells with highly deviated directional or horizontal well bores.

Figure 15 provides a simplified evaluation flowchart showing the basic steps for evaluating whether a plunger lift system will be technically feasible and profitable.

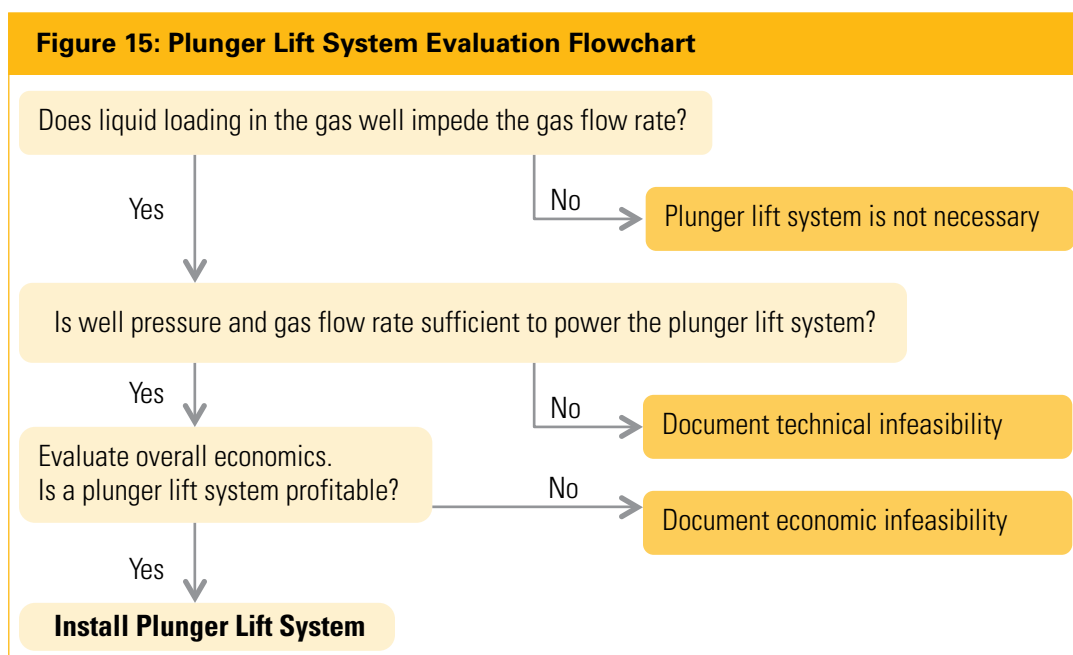

4.3 TRI-ETHYLENE GLYCOL DEHYDRATOR EMISSION CONTROLS

Glycol dehydrators are used to remove moisture from natural gas to improve gas quality, minimize corrosion in the gas sales line, and mitigate gas hydrate formation. A number of different glycols can be used in dehydration systems (e.g. triethylene glycol (TEG), diethylene glycol (DEG), ethylene glycol (MEG), and tetraethylene glycol (TREG)). TEG is the most commonly used glycol in industry.⁸¹ TEG dehydrators vent methane gas to the atmosphere, but in many cases methane gas can be captured instead.

4.3.1 Technology Description

In some cases, if the design criteria can be met, a TEG dehydrator can be replaced with a desiccant dehydrator (see Section 4.4). However, desiccant dehydrators are limited to low gas flow rates—less than 5 MMcf— and have temperature and pressure limitations. Therefore, for higher gas flow rates, the best solution is often to retrofit existing TEG dehydrators with emission controls.

A typical glycol dehydration system includes a glycol contactor, a glycol exchange pump, a driver to run the pump, and a glycol regenerator and reboiler. In some cases, a condenser is also installed downstream of the glycol regenerator. Figure 16 provides a schematic for a typical glycol dehydration unit. As shown in the diagram, natural gas with moisture content exceeding pipeline specifications (“wet gas”) enters the glycol dehydration system and

moisture is removed to achieve pipeline specifications (“dry sales gas”).

A typical glycol dehydration system includes the following components:

- Glycol contactor:** Wet gas enters the glycol contactor. Glycol removes moisture from the gas by the process of physical absorption. Along with removing moisture, the glycol also absorbs methane, VOCs, and HAPs. Dry gas exits the glycol contactor absorption column and is either routed to a pipeline or a gas plant. The glycol contactor unit plays the primary role in dehydrating the gas to pipeline specifications, but the rest of the glycol dehydration system is required to convert the now moisture rich glycol back into a lean product that can be reused to dehydrate more incoming gas. Therefore, the next step in the process is to route the moisture rich glycol to regenerator and reboiler units to remove that moisture.
- Glycol regenerator & reboiler:** Glycol loaded with moisture, methane, VOCs, and HAPs (“rich glycol”) exits the bottom of the glycol contactor unit and is routed to the glycol regenerator and reboiler units to remove the absorbed components and return “lean” glycol back to the glycol contactor. If emission controls are not installed, methane, VOCs, HAPs, and water are boiled off and vented to atmosphere from the regenerator and reboiler units. One way to limit the amount of methane, VOCs, and HAPs emitted to the atmosphere from the regenerator and reboiler units is to install a flash tank separator.

Figure 16: Glycol Dehydration Unit Schematic

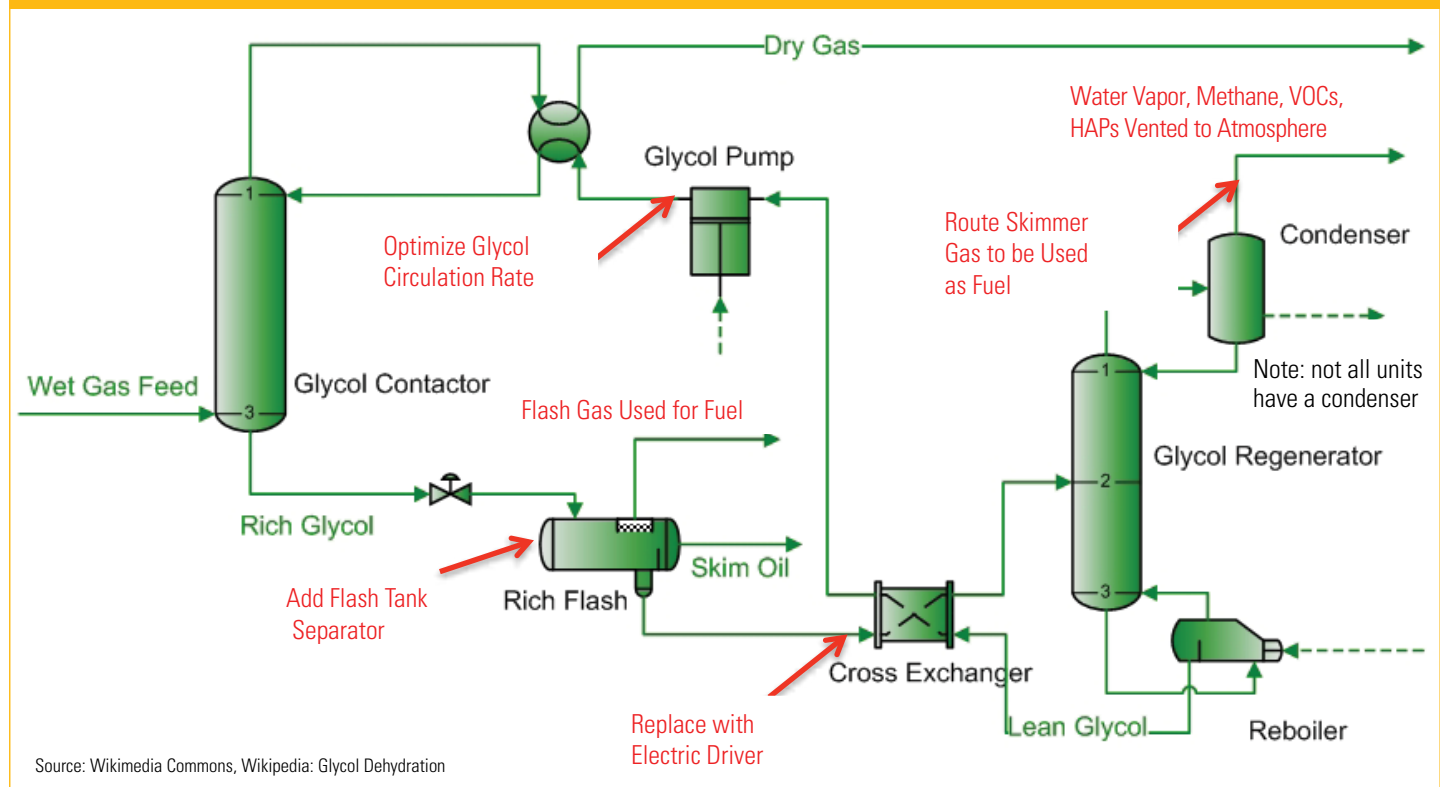

Source: Wikimedia Commons, Wikipedia: Glycol Dehydration

- **Flash tank separator:** Installation of a flash tank separator between the glycol contactor and the glycol regenerator/reboiler units creates a pressure drop in the system, allowing methane, and some VOCs and HAPs, to flash out of, or separate from, the glycol. The amount of pressure drop that can be created is a function of the fuel gas system pressure or compressor suction pressure because the methane gas flashed-off at the flash tank separator is then sent to be used as fuel in the TEG reboiler or compressor engine. Simply put, the pressure can only be dropped to a pressure that still exceeds the fuel gas pressure, allowing the collected methane gas to flow into the fuel system. Flash tank separators typically recover 90 percent of the methane and approximately 10 to 40 percent of the total VOCs that would otherwise be vented to atmosphere. Methane emissions can also be controlled by taking the simple step of adjusting the rate at which glycol circulates in the system.
- **Glycol recirculation pump:** Methane emissions are directly proportional to the glycol circulation rate. Circulating glycol at a rate that exceeds the operational need for removing water content from gas unnecessarily increases methane emissions. Glycol circulation rates are typically set at the maximum to account for peak throughput. Gas pressure and flow rate decline over time, requiring the glycol circulation rate to be adjusted to meet operational need. Optimizing the glycol circulation merely requires an engineering assessment and a field operating adjustment. If the glycol dehydration unit includes a condenser, methane emissions can be collected and used for fuel or destroyed rather than being vented to atmosphere.
- **Condensers:** Some glycol reboilers have still condensers to recover natural gas liquids and reduce VOCs and HAPs emissions. However, condensers do not capture methane (because it is a non-condensable gas); therefore, the addition of a condenser does not reduce methane emissions. In these cases, methane gas is typically vented to atmosphere. Alternatively, this methane gas (called “skimmer gas”) can be routed to the reboiler firebox or other low-pressure fuel gas systems.⁸²
- **Electric pumps or energy-exchange pumps:** Historically, gas-assisted glycol pumps have been used. Where there is an electric supply, the gas-assisted glycol pumps can be replaced with an electric pump. Gas-assisted pumps are driven by expansion of the high-pressure gas entrained in the rich glycol that leaves the contactor, supplemented by the addition of untreated high-pressure wet (methane rich) natural gas. The high-pressure gas drives pneumatic pumps. Much like pneumatically operated valves, pneumatically operated pumps vent methane. Electric pumps would reduce emissions, since they do not vent methane.

Regarding electric pumps or energy-exchange pumps, the EPA reports:

“The mechanical design of these pumps places wet, high-pressure TEG opposed to dry, low pressure TEG,

separated only by rubber seals. Worn seals result in contamination of the lean (dry) TEG making it less efficient in dehydrating the gas, requiring higher glycol circulation rates. Replacing gas-assisted pumps with electric pumps increases system efficiency and significantly reduces methane emissions.”⁸³

By comparison, electric pumps have lower emissions and no pathway for contamination of lean TEG by the rich TEG.

In summary, there are four straightforward solutions readily available to control methane emissions from TEG dehydrator units:

- Installing a flash tank separator
- Optimizing the glycol circulation rate
- Rerouting the skimmer gas
- Installing an electric pump to replace the natural gas driven energy exchange pump

4.3.2 Opportunity

Reduction Target 8 Bcf/year

The 2011 *Greenhouse Gas Inventory* estimates that gas dehydration systems emit approximately 8 Bcf of methane annually.⁸⁴

In 2009, the EPA estimated that there were approximately 36,000 glycol dehydrators in operation in the U.S. natural gas sector.⁸⁵

While a number of large glycol dehydrators are currently required by the EPA to install emission controls under the federal Maximum Achievable Control Technology standards (MACT standards at 40 CFR Part 63, Subpart HH), small glycol dehydrators are typically exempt from federal emission control requirements. Many small glycol dehydrator units do not have flash tank separators, condensers, electric pumps, or vapor recovery installed on the glycol regenerator.

Many small glycol dehydrators operating in the United States are exempt from federal emission control

Table 5: Methane Capture Potential from TEG Dehydrator Controls

Technology	Methane Capture Mcf/year
Flash Tank Separator	3,650
Optimize Glycol Circulation Rate	18,250
Reroute Skimmer Gas	7,665
Install Electric Pump	5,000
Potential Methane Capture Range	3,650 to 34,565

A significant fraction of this 8 Bcf/year of emissions from this source can and should be captured (Table 5).

Installing Flash Tank Separator: In 2005, the EPA estimated that the installation of a flash tank separator, on average, resulted in 10 Mcf/day (3,650 Mcf/year) of methane gas captured for use as fuel for each TEG dehydrator (typically a 90 percent reduction in methane emissions).

In 2009, the EPA reported that flash tank separators were only installed on 15 percent of the dehydration units processing less than 1 MMcfd, 40 percent of units processing 1 to 5 MMcfd, and between 65 and 70 percent of units processing more than 5 MMcfd.⁸⁶ Chevron reported it has installed flash tank separators, recovering 98 percent of the methane from the glycol and reducing methane emissions from 1,450 Mcf/year to 47 Mcf/year.⁸⁷

Optimizing Glycol Circulation Rate: In 2005, the EPA estimated that optimizing the glycol circulation rate could result in a wide range of methane capture from 1 to 100 Mcf/day (18,250 Mcf/year using a median estimate of 50 Mcf/day).⁸⁸

Rerouting Glycol Skimmer Gas: In 2005, the EPA estimated that rerouting glycol skimmer gas could result in an average methane capture of 21 Mcf/day (7,665 Mcf/year).⁸⁹

Installing Electric Pump: In 2007, the EPA estimated that between 360 and 36,000 Mcf/year in methane emission reductions could be achieved by installing an electric pump to replace the natural gas-driven glycol energy exchange pump. The wide range in methane emission reductions is a function of the large variation in equipment sizes. In Table 5 we use the number 5,000 Mcf/year per electric pump.⁹⁰

In 2007, the EPA determined that the total potential emission reductions at any given glycol dehydration unit is a function of how many of these emission control solutions

are installed, and estimated that the total reduction potential may range from 3,600 to 35,000 Mcf/year, or \$14,600 to \$138,000 of annual revenue. The 2011 *Greenhouse Gas Inventory* estimates the upper range of emissions at 38,000 Mcf/year.⁹¹

4.3.3 Proposed EPA Regulations

The EPA's proposed air toxics standards would cover new and existing small dehydrators located at major sources of HAPs.⁹² The EPA classifies small dehydrators as units with an annual average gas flow rate less than 3 million Mcf/day at production sites, or 9.99 million Mcf/day at natural gas transmission and storage sites, or actual average benzene emissions less than 0.9 Mg/year.

4.3.4 Profit

The EPA estimates that it costs on average:

- \$5,000 to install a flash tank separator
- Less than \$100 to adjust the glycol circulation rate
- \$1,000 per unit to reroute glycol skimmer gas, with \$100 per year of operating and maintenance costs⁹³
- \$1,400 to \$13,000 to install an electric pump⁹⁴

These technologies can be installed singly or in combination. Each unit, if equipped with the above technology, would capture approximately 3,600 to 35,000 Mcf per unit, per year. This translates to profits of between \$14,000 and \$138,000 per unit per year, as shown in greater detail in Appendix A Table A3. This technology has a payback period of less than a year, and can generate significant profits each year thereafter.

Figure 17: TEG Dehydrator Emission Control Evaluation Flowchart

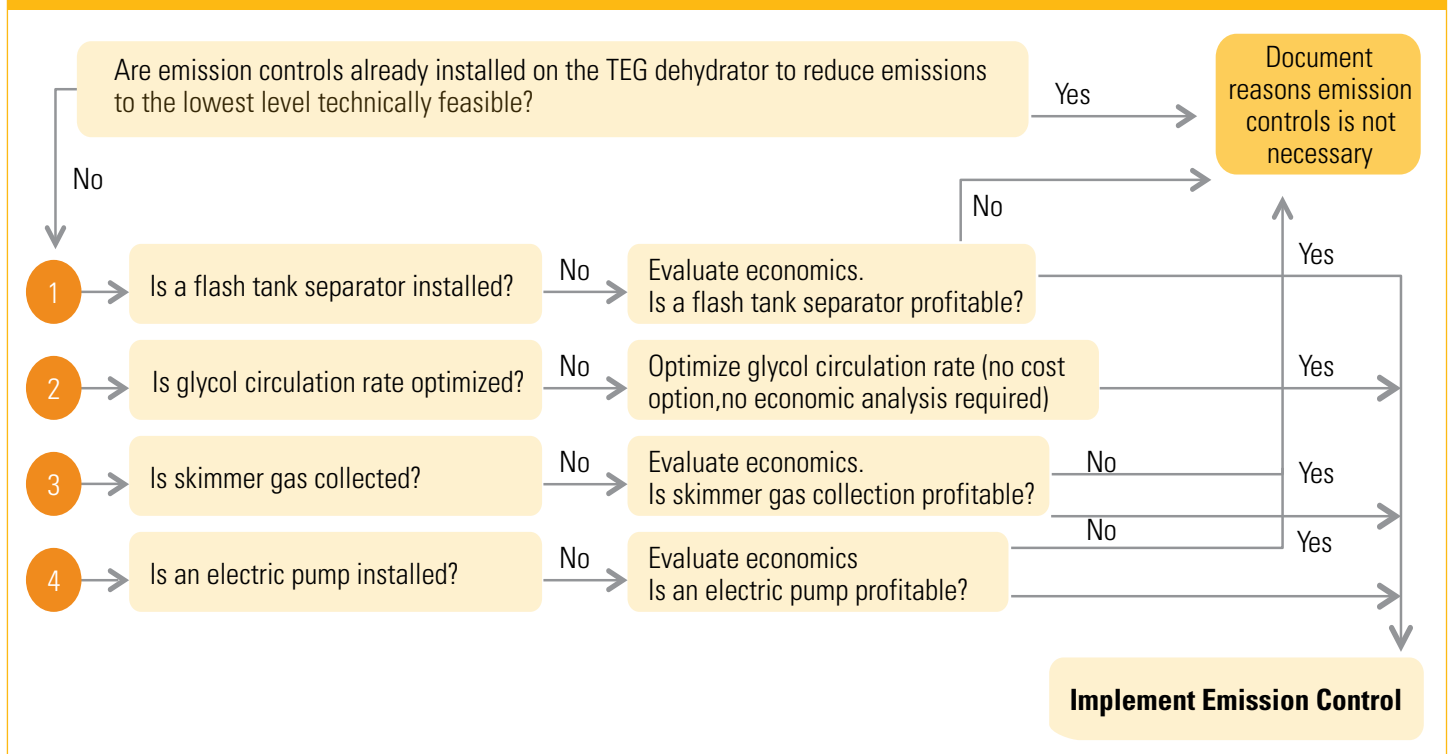

4.3.5 Additional Benefits

One of the most important benefits of TEG dehydrator emission controls is the opportunity to reduce the amount of HAPs emitted to the atmosphere, especially benzene, a known human carcinogen. Along with methane gas, TEG dehydrators vent VOCs and HAPs to the atmosphere. In some cases, glycol dehydrators have still condensers and condensate separators to recover natural gas liquids and reduce VOCs and HAPs. But, if these units are not installed, VOC and HAP components (including benzene) are vented into the atmosphere.⁹⁵

The installation of a flash tank separator reduces VOC and HAP emissions, improving air quality. The installation of a flash tank separator also improves the efficiency of downstream components (e.g. condensers) and reduces fuel costs by providing a fuel source to the TEG reboiler or compressor engine.⁹⁶

4.3.6 Limitations and Evaluation

The option to reroute the skimmer gas can be employed only on dehydrators where a still condenser is installed. The following factors should be evaluated in assessing feasibility of installing an electric pump to replace the natural gas driven glycol energy exchange pump, as electricity may not be available at a remote well site: (1) the local electric grid's potential to make electric power available to a well site, (2) the potential to self-generate electricity on site using waste gas that might otherwise be vented or flared, or (3) availability of solar power.

Figure 17 provides a simplified evaluation flowchart showing the basic steps for evaluating whether TEG dehydrator emission controls are appropriate.

4.4 DESICCANT DEHYDRATORS

Desiccant dehydrators can be used as alternatives to glycol dehydrators to remove moisture from natural gas to improve gas quality, minimize corrosion in the gas sales line, and mitigate gas hydrate formation. Desiccant dehydrators do not emit significant quantities of methane gas into the atmosphere, and reduce emissions by up to 99 percent.

4.4.1 Technology Description

Desiccant dehydrators dry gas by passing the gas through a bed of sacrificial hygroscopic salt (the desiccant).⁹⁷ The salt type—typically calcium chloride (CaCl_2) or lithium chloride (LiCl)—is selected based on gas temperature and pressure and to match the gas operating conditions, as shown in Figure 18. Unlike a traditional glycol dehydrator, there are no pumps, contactors, regenerators, or reboilers, and only a small amount of methane is released intermittently when the unit is opened to replace the salt.

The amount of moisture that can be removed from a gas

Figure 18: Desiccant Dehydrator Schematic

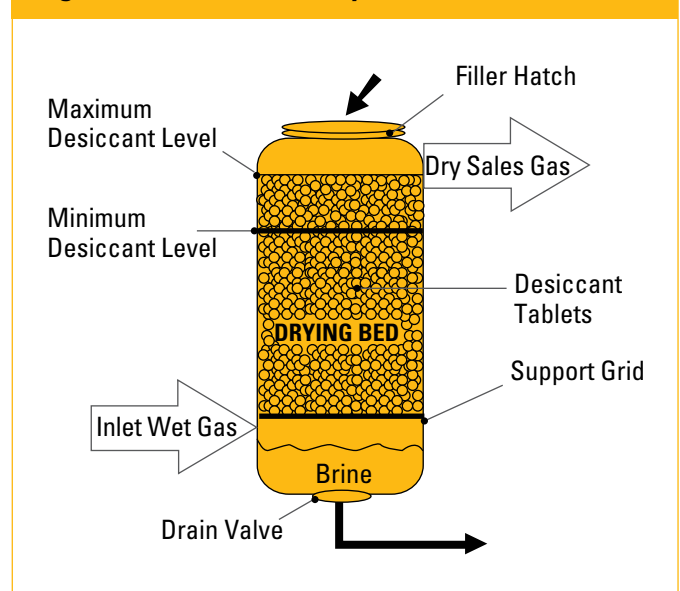

stream is a function of the gas pressure and temperature. At high gas temperatures, desiccant dehydrators can form gas hydrates, which can plug the unit. Therefore, desiccant dehydrators are best suited for 5 MMcfd gas flow rates or less, with a low wellhead gas temperature (less than 70 degrees Fahrenheit). Glycol dehydrators are needed for gas flow rates exceeding 5 MMcfd, for higher gas pressures, or when operation is required over a wide range of pressures.⁹⁸

4.4.2 Opportunity

Reduction Target: 8 Bcf/year

The 2011 *Greenhouse Gas Inventory* estimates that gas dehydration systems emit approximately 8 Bcf of methane annually.⁹⁹

Desiccant dehydrators can be used to replace an existing TEG dehydrator. When this occurs, there is an initial capital investment required. For example, a 1 MMcfd unit costs about \$12,500 to \$16,000, but the operating and maintenance costs for a desiccant dehydrator are lower than those for a TEG unit (cost savings of about \$1,800/year).^{100,101} The EPA estimates that replacing a small TEG dehydrator with a desiccant dehydrator will capture about 1,000 Mcf/year of methane.¹⁰² Larger units—up to 5 MMcfd—will cost incrementally more, but will have corresponding lower operating and maintenance costs and higher methane emission recovery.¹⁰³

Of the 8 Bcf/year reduction target for dehydrators, most of the emissions are from small dehydrators that are exempt from MACT standards. Using desiccant dehydrators to replace aging glycol dehydrators, or as a lower emission alternative for new dehydration units, will reduce methane emissions from small dehydrators.

4.4.3 Proposed EPA Regulations

The EPA's proposed new air toxics standards include new and existing small dehydrators. Desiccant dehydrators are not specifically required.

While these proposed standards would cover both small and large glycol dehydrators, the EPA estimates that only 0.024 Bcf/year of methane would be captured (about 0.3 percent of the emissions from this source).

The EPA's proposed standards could be strengthened by requiring:

- Air toxics reductions of 98 percent (up from the proposed 95 percent)
- Better operational practices (e.g. optimized circulation rates)
- Portable desiccant dehydrators used during maintenance, and desiccant dehydrators for gas flow rates of 5 MMcfd or less.

4.4.4 Profit

If a desiccant dehydrator is technically feasible in a new installation, it will be more profitable than a TEG dehydrator. In addition to having lower capital and operating and maintenance costs than a TEG dehydrator, it has the added benefit of being able to collect methane for sale.

The EPA estimates that profit could amount to \$6,000 per year, including operations and maintenance savings. The initial investment of \$16,000 for replacing a glycol dehydrator with a desiccant dehydrator is paid out in less than three years, as shown in greater detail in Appendix A, Table A4.¹⁰⁴

In 2007, BP reported that it eliminated 858 glycol dehydrators, replacing them with desiccant dehydrators, for a \$27 million profit and “immediate-payout.” This amounts to a profit of \$31,469 per unit total, or about \$31,000 per year averaged over a 10-year period.¹⁰⁵

4.4.5 Additional Benefits

Unprocessed natural gas contains VOCs and HAPs, along with methane. Therefore, capture of this gas also reduces VOC and HAP pollution.

4.4.6 Limitations and Evaluation

Desiccant dehydrators produce a liquid brine waste that must be either routed to a produced water tank for reinjection or disposed of as waste. There are also pressure, temperature, and gas flow limitations.

Figure 19 provides a simplified evaluation flowchart showing the basic steps for evaluating whether a desiccant dehydrator would be an option.

4.5 DRY SEAL SYSTEMS

Centrifugal compressors are used in the production and transportation of natural gas. Centrifugal compressors installed with wet seals have high-pressure seal oil that circulates between rings around the compressor shaft. This high-pressure oil is used as a barrier to prevent gas escape. The seal oil absorbs methane gas, however, and later the methane is vented to atmosphere, when the compressor seal oil gas is vented in a process called “seal oil degassing” (Figure 20).

Instead of using seal oil (wet seal), centrifugal compressors can use dry seals, in which high-pressure gas is used to seal the compressor. Changing out wet seals and installing dry seals reduces methane venting (Figure 21).

Wet seal technology is being phased out. In fact, more than 90 percent of new compressors are being sold with dry seal technology, due to the environmental and cost savings benefits it offers.

Figure 19: Desiccant Dehydrator Evaluation Flowchart

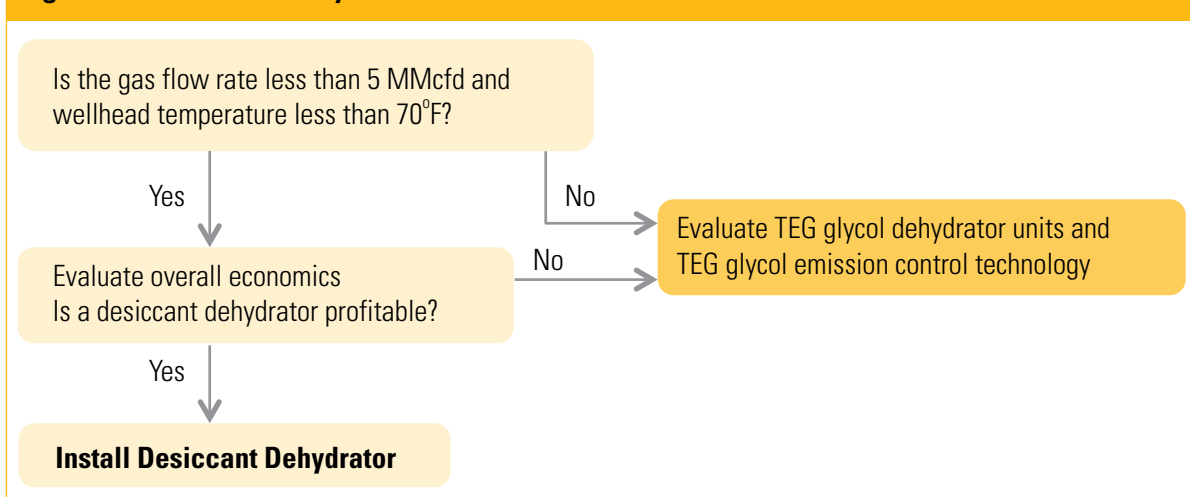

4.5.1 Technology Description

Dry seals prevent methane leaks by pumping gas between the seal rings, creating a high-pressure leak barrier when the compressor shaft is rotating (Figure 21). Typically, two dry seals are used in tandem to prevent gas leakage. When the compressor shaft is not rotating, the dry seal housing is pressed up tight against the rotating ring using a “dry seal spring,” thereby preventing gas leaks.¹⁰⁶

4.5.2 Opportunity

Reduction Target: 27 Bcf/year

The 2011 *Greenhouse Gas Inventory* estimates that approximately 1,500 centrifugal compressors with wet seals were operating in the U.S. O&G industry, with rod packing systems emitting approximately 27 Bcf of methane annually, a significant fraction of which can and should be captured.¹⁰⁷

The EPA estimates that 80 percent of natural gas compression station methane emissions are emitted from compressors.¹⁰⁸ If wet seals are used in compressors for other applications in gas production, those compressors can also emit large amounts of methane. According to the EPA, wet seal oil degassing may vent between 40 and 200 standard cubic feet per minute (scfm), compared to about 0.5 to 3 scfm with a dry seal.¹⁰⁹ Dry seal technology offers a technically and economically feasible alternative to reduce these methane emissions.

4.5.3 Proposed EPA Regulations

The EPA’s proposed NSPS regulations would require the use of dry seals for each new or modified centrifugal compressor located in the processing, transmission, and storage sectors. The standards would not apply to compressors at a well site or in the distribution sector.

The EPA estimates that the proposed NSPS would reduce methane emissions from compressors with wet seals by about 0.25 Bcf/year, about 1 percent of the compressor methane emissions from this source. This low control percentage is primarily because the NSPS would only affect new or modified or replaced leakage sources, while the bulk of the emissions are from existing sources.

The proposed regulations could be further enhanced by requiring equipment and operational requirements for existing compressors. New compressors represent just 2 percent of all centrifugal compressors in the processing, transmission and storage sectors. Compressors are added or replaced in these sectors at an extremely low rate. Therefore, a standard applying only to such compressors would leave most of the emissions untouched.

Figure 20: Centrifugal Compressor Leaks Schematic

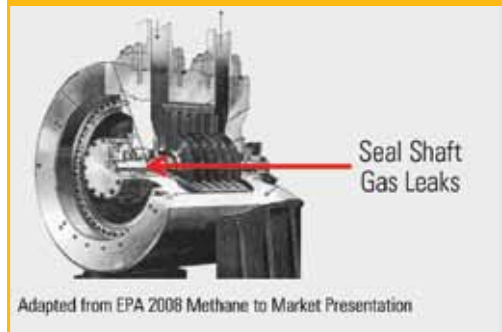
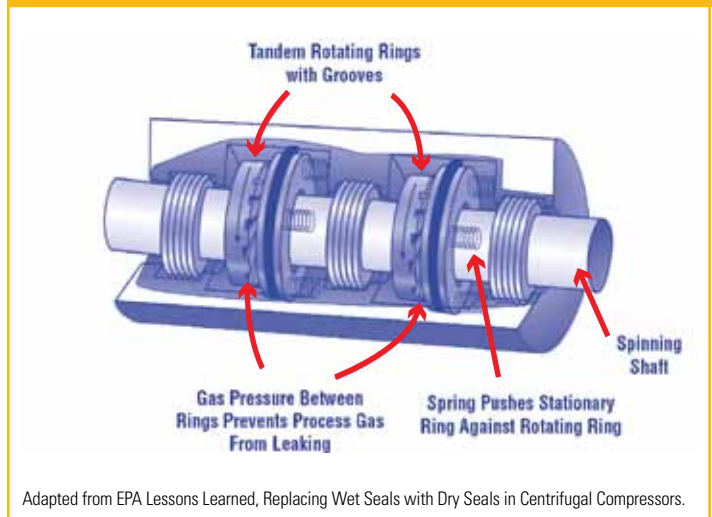

Figure 21: Centrifugal Compressor Dry Seals



4.5.4 Profit

The actual costs for a dry seal system will depend on compressor operating pressure, shaft size, rotation speed, and other site-specific factors. The EPA reports that a dry seal retrofit costs on average \$324,000, but results in an operations and maintenance cost savings of more than \$100,000 per year and can generate up to \$400,000 in additional annual revenue from captured methane, resulting in a payout of approximately one year.^{110,111} One of the major factors in the profit equation is the lower O&M costs for dry seals—\$8,400 to \$14,000 per year—compared to wet seal costs of \$140,000 per year per compressor or more.

The EPA’s 2011 *Greenhouse Gas Inventory* and other sources estimate the leak rate to be approximately 18,000 to 100,000 Mcf per year. If captured and sold, this could annually yield up to \$400,000 in additional revenue, and up to \$120,000 in operations and maintenance savings. Additional details are provided in Appendix A, Table A5.

Using the EPA’s estimate that wet seal oil degassing may vent between 58 and 288 Mcf/day, compared to 0.7 to 4 Mcf/day with a dry seal, and using current gas prices, an

operator may save up to \$400,000 per year, per compressor.¹²² However, the actual profits will vary based on site-specific circumstances.

In 2008, Petróleos Mexicanos (PEMEX) assessed the benefits of converting from wet seals to dry seals on centrifugal compressors at a compression station in southern Mexico.¹¹³ PEMEX found a gas savings of 33.5 scfm per seal, and a gas savings of 35,000 Mcf/year (resulting in greenhouse gas emissions reduction of 7,310 metric tons of carbon dioxide equivalent per year), and a profit of \$126,690 annually.¹¹⁴

Targa Resources and the Gas Processors Association report that replacing a wet seal with a dry seal on a 6 inch shaft beam compressor that operates approximately 8,000 hours per year, leaking at 40 to 200 scfm, will pay out in four to 15 months, yielding more than \$1 million in net present value, assuming a 10 percent discount rate in a span of five years, and more than a 170 percent rate of return.¹¹⁵

4.5.5 Additional Benefits

Upgrading compressor seals can reduce power requirements and downtime, improve compressor reliability, and lower operating costs by eliminating seal oil costs and associated maintenance.¹¹⁶

4.5.6 Limitations and Evaluation

A compressor-specific, site-specific evaluation is necessary to determine if conversion to dry seals is technically feasible. A conversion to dry seals may not be possible on some

compressors because of compressor housing design or other operational or safety factors.

Figure 22 provides a simplified evaluation flowchart showing the basic steps for evaluating a dry compressor seal conversion.

4.6 IMPROVED COMPRESSOR MAINTENANCE

Reciprocating compressors leak methane from a component called a rod packing case. A common practice is to route the rod packing emissions outside the compressor building and vent the methane emissions directly into the atmosphere. Methane emissions can be reduced by replacing worn out rod packing.

4.6.1 Technology Description

Rod packing systems are used to maintain a seal around the piston rod, preventing gas compressed to a high pressure in the compressor cylinder from leaking, while still allowing the piston rod shaft to move freely. A series of flexible rings are fitted around the piston rod shaft, held in position by packing material and springs.

Methane leaks occur between the rings and piston rod shaft, around the outside of the rings, and between the packing (Figure 23). Packing leaks can occur for a number of reasons, such as a worn piston rod, an incorrect amount of lubrication, dirt or foreign matter in the packing, or packing material out of tolerance.¹¹⁷ The amount of leakage will be a

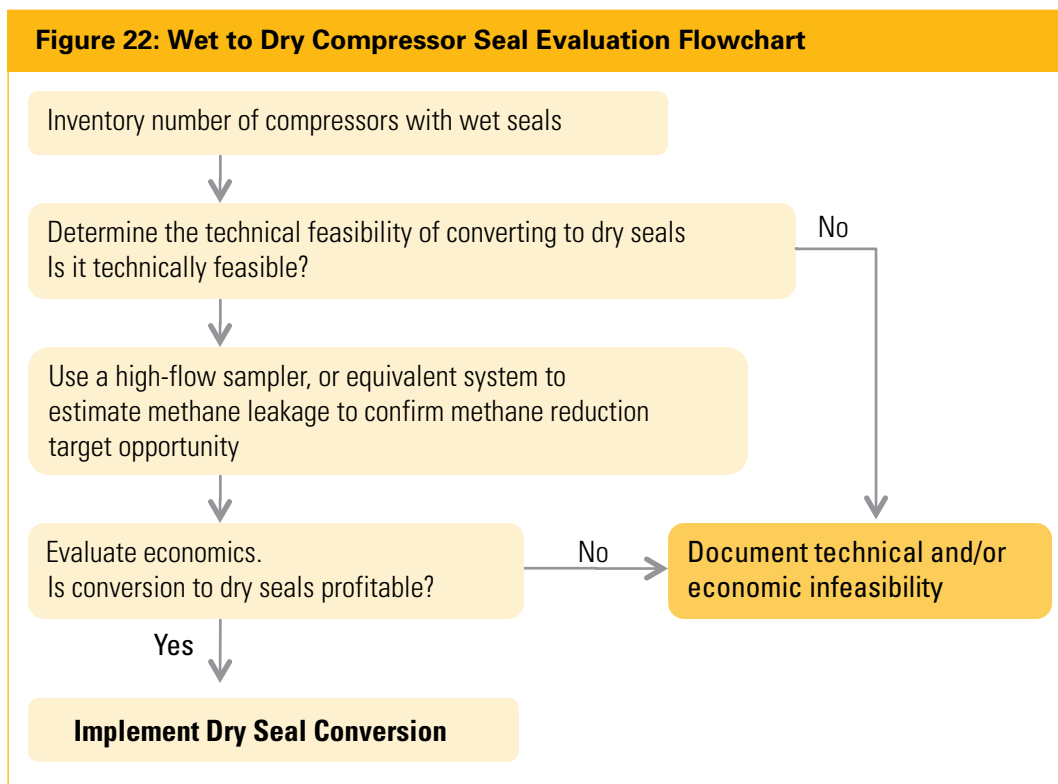

function of the amount of misalignment between the piston rod, packing materials, and rings and packing case. Also, misalignment of the piston rod and any imperfections on the piston rod surface can cause leakage.¹¹⁸

Rod packing case leaks are also a function of the quality of initial installation, packing material selection, and the way in which the unit was operated during the initial, or break-in, operating period.

Figure 23: Reciprocating Compressor Rod Packing Leaks Schematic

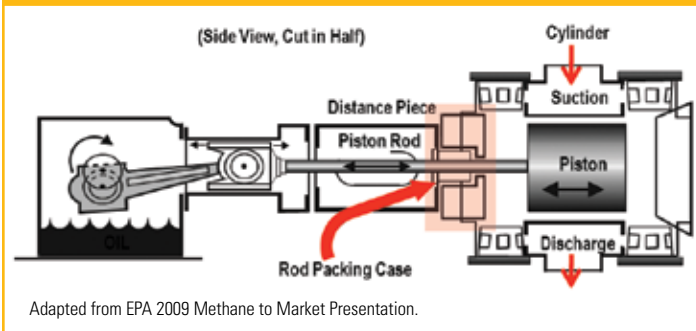

4.6.2 Opportunity

Reduction Target: 75 Bcf/year

In 2006, the EPA estimated that more than 51,000 reciprocating compressors were operating in the U.S. natural gas industry with, on average, four cylinders each, for a total of more than 200,000 piston rod packing systems in service.¹¹⁹ The 2011 *Greenhouse Gas Inventory* estimates that these systems emit 75 Bcf of methane annually, a significant fraction of which can and should be captured.¹²⁰

As with centrifugal compressors, an impediment to rod packing replacement is the equipment downtime required to make the replacement. However, routine repair and maintenance is a good business practice.

4.6.3 Proposed EPA Regulations

The EPA's proposed NSPS regulations for reciprocating compressors require replacement of rod packing every 26,000 hours of operation (approximately every three years). These standards would only apply to reciprocating compressors at processing stations, gathering and boosting stations, transmission stations and underground storage facilities. The standards would not apply to compressors at a well site or beyond the city gate (distribution sector).

The EPA estimates that the proposed NSPS regulations would reduce emissions from reciprocating compressors by about 0.3 Bcf/year, less than 1 percent of the methane emissions from these sources. This is primarily because the NSPS would only apply to new or replaced reciprocating compressors starting from the time of installation, whereas

the bulk of the emissions come from existing compressors. It does not appear that the proposed standards would apply when an existing compressor is taken offline for maintenance.

The proposed regulations could be further strengthened by requiring equipment and operational requirements for existing compressors. New compressors represent just 3 percent of all reciprocating compressors in the processing, transmission and storage sectors. Compressors are added or replaced in these sectors at a low rate; therefore, a standard applying only to new compressors will leave most of the emissions untouched. The EPA should also require emission abatement at the wellhead (production sector). While replacement based on hours of operation is a good minimum threshold, the EPA should also consider requiring regular leak-rate tests and early replacement if leakage is deemed too high.

4.6.4 Profit

Operators that carefully monitor and replace compressor rod packing systems on a routine basis can reduce methane emissions and reduce piston rod wear, both of which increase profit.¹²¹

The 2011 *Greenhouse Gas Inventory* uses a leak rate of 875 scf/hour (21,000 scf/day), equating to approximately \$100 of gas leaking from each compressor each day it is not repaired.

The EPA estimates that refurbishing the rings and packing material may cost between \$135 and \$2,500, depending on the size of the unit. Rod replacement can range from \$2,400 to \$13,500, depending on the number of rods replaced.¹²²

The pace at which replacements are necessary is a function of the compressor type, use, maintenance and operating conditions, and is highly variable. In most cases, though, payout is achieved in less than a year. The EPA has estimated that on average, the annual investment expense of replacing one rod packing system is about \$600, with an initial investment of about \$1,600. The methane gas captured has a value of about \$3,500 per year, allowing payout to be achieved in less than half a year.¹²³ Another EPA reference reports a slightly lower initial cost for replacing rod packing of \$1,200, but with similar natural gas savings, to allow for payout in less than half a year.¹²⁴ Additional detail is shown in Appendix A, Table A6.

4.6.5 Additional Benefits

Collection of methane and other gas vapors at O&G operations creates a safer working environment by reducing potentially combustible vapors at the work site.

4.6.6 Limitations and Evaluation

One major consideration in deciding whether to replace worn rod packing is the cost and feasibility of taking the compressor out of service to make the repair. Larger facilities with spare compressor capacity will not be as significantly

affected as smaller operations, where repairs may require a complete shutdown. Other variables affecting cost savings include the amount of wear already on the rings and rod shaft, fit and alignment of packing parts, and cylinder pressure.

Figure 24 provides a simplified evaluation flowchart showing the basic steps for evaluating rod packing replacement.

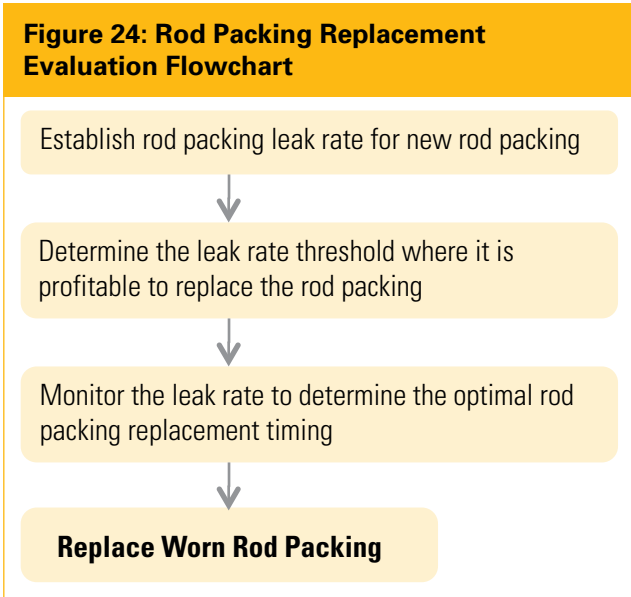

4.7 LOW-BLEED OR NO-BLEED PNEUMATIC CONTROLLERS

Pneumatic controllers are used to regulate pressure, gas flow, and liquid levels, and to automatically operate valves. They are used extensively in the O&G industry.

Pneumatic controllers are designed to release methane gas to the atmosphere as part of normal operations. Some pneumatic controllers bleed at a low rate (low-bleed) and others bleed at a high rate (high-bleed). A high-bleed

Figure 25: Pneumatic Controller



iStockphoto

controller is defined by the EPA Natural Gas STAR Program as a device that releases 6 scf/hour or more. Converting high-bleed controllers to low-bleed controllers, or moving away from gas-operated controllers altogether in favor of instrument air controls, reduces methane emissions.

Colorado requires O&G operators to install low-bleed or no-bleed pneumatic controllers at all new facilities and whenever a device is repaired or replaced, if technically feasible.¹²⁵ Wyoming’s Oil and Gas Production Facility Guidance includes upgrading to low-bleed or no-bleed pneumatic controllers, or routing methane to a collection system during a repair or replacement.¹²⁶

4.7.1 Technology Description

Pneumatic controllers use clean, dry pressurized natural gas to provide a power supply to measure process conditions (e.g. liquid level, gas pressure, flow rate, temperature) and control

Figure 26: Pneumatic Controller Locations in Natural Gas Production

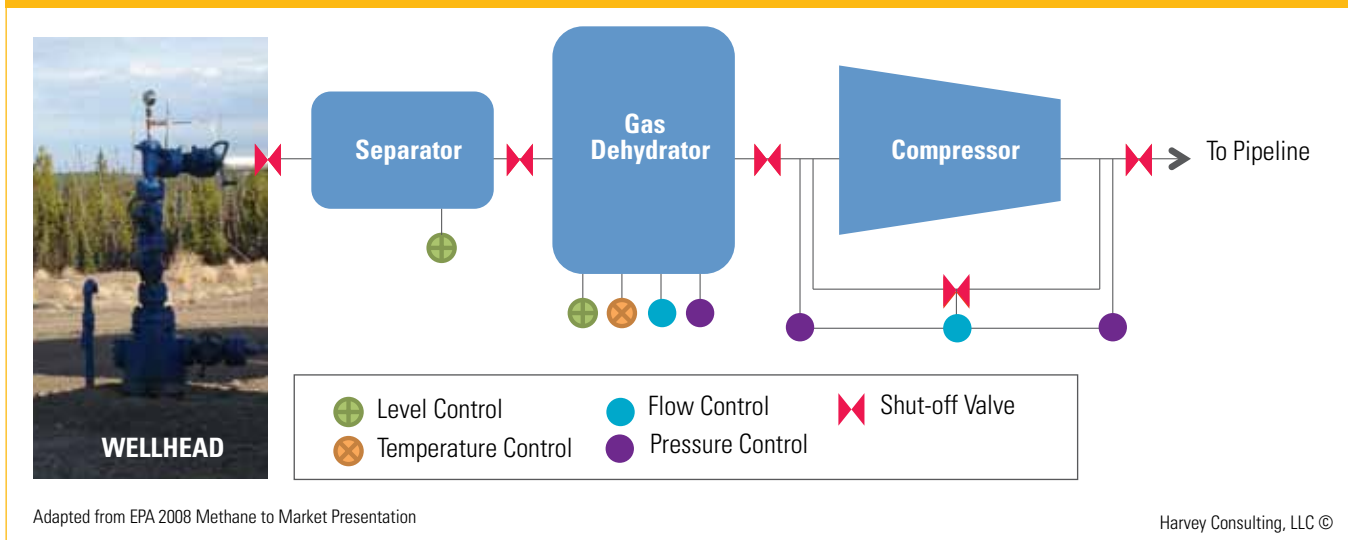

the conditions to a set point. Figure 25 shows a pneumatic controller. Figure 26 shows the locations in O&G operations where pneumatic controllers may be used.

There are three main pneumatic controller designs:

1. Intermittent bleed controllers that release gas only when the valve is stroked open or closed
2. Continuous bleed controllers that modulate flow, liquid levels, or pressures
3. Self-contained controllers that release gas back into piping and not to the atmosphere¹²⁷

There are four main options for reducing methane emissions from pneumatic controllers:

1. Replacing high bleed pneumatic controllers with low- or no-bleed controllers
2. Retrofitting pneumatic controllers with bleed reduction kits
3. Converting natural gas pneumatics to instrument air
4. Performing routine maintenance to repair leaking gaskets, tube fittings, and seals

4.7.2 Opportunity

Reduction Target: 99 Bcf/year

The 2011 *Greenhouse Gas Inventory* estimates that pneumatic controllers vented 99 Bcf of methane into the atmosphere.¹²⁸ Emissions are primarily generated from the production, processing, and transmission and storage sectors. The EPA also estimates that 84 percent of pneumatic controller emissions come from O&G production.¹²⁹ According to the American Petroleum Institute, there are approximately 1 million existing wells, and three controllers per well, indicating that there are a minimum of three million controllers in operation at well sites alone. The EPA reports that the typical high-bleed controller releases 140 Mcf/year of gas to the atmosphere.¹³⁰ Fortunately, nearly 80 percent of all high-bleed pneumatic controller can be replaced with low-bleed equipment or retrofitted to reduce methane emissions.¹³¹

Taking into account the EPA's assessment that 80 percent of high-bleed devices can be replaced or retrofitted, we consider that a very large fraction of the 99 Bcf/year emissions can be captured.

4.7.3 Proposed EPA Regulations

The EPA's proposed NSPS regulations require instrument air controllers that have zero methane emissions to be installed at processing plants. The EPA also proposes that low-bleed pneumatic controllers, with a limit of 6 scfh, be used in the production, transmission, and storage sectors. Requirements would apply to newly installed pneumatic controllers, including replacement of existing devices. The proposal

would exclude pneumatic controllers that are located in the distribution segment, as well as existing controllers.

The EPA estimates that the proposed NSPS regulations would reduce emissions from high-bleed pneumatic controllers by about 4.5 Bcf/year, or about 5 percent. The emission reduction is small because the proposed NSPS would only apply to pneumatic controllers at the time of installation, whereas the bulk of the emissions are from the existing fleet of controllers.

NRDC recommends that the EPA should require that existing sources be controlled to maximize methane emission reductions. The EPA should also consider regulating emission reductions from the distribution sector, and requiring no-bleed controllers at locations outside the processing sector where feasible.

4.7.4 Profit

In 2005, the EPA reported that the incremental cost of replacing high-bleed controllers with low-bleed controllers was approximately \$350 per device, resulting in a \$1,100 annual operating and maintenance cost savings and a payback of less than one year for each device.¹³² Natural gas savings of \$700 or more is also possible. The EPA estimates that retrofitting a pneumatic controller with a bleed reduction kit costs, on average, \$500, and pays out in nine months.¹³³ An EPA *Lessons Learned* report from 2006 also reports similar cost and natural gas savings, but with smaller operational and maintenance savings.¹³⁴

While conversion from natural gas pneumatic controllers to instrument air is estimated to be more costly, at \$10,000 per conversion and \$7,500 in annual operating and maintenance costs, there are substantial annual natural gas savings of more than \$20,000 per year and payback in less than two years.^{135,136} In 2006, the EPA estimated the cost/benefit of replacing large gas-operated controllers with instrument air controllers.¹³⁷ The EPA estimated the cost to be approximately \$60,000 per controller. The natural gas savings were commensurately larger at approximately \$80,000 per year, rendering the investment profitable with a payback period of just under one year. Additional detail is shown in Appendix A, Table A7 and A8.

BP reported that it replaced 11,500 high-bleed pneumatic controllers with low- or no-bleed controllers in six states, during the period of 1999 to 2002, capturing 3.4 Bcf/year.¹³⁸ The program yielded a net present value of \$65 million for a capital investment of \$4 million. BP also reported that it had installed 411 pneumatic pump pressure regulators, reducing gas use by 0.4 Bcf/year, at a cost of less than \$50,000, for a net present value of \$8.4 million.

QEP Resources Inc., Shell Upstream Americas, Ultra Petroleum, Devon Energy, EnCana, and other gas producers in Wyoming have replaced pneumatic controllers with new low-bleed controllers. Instead of gas venting the gas is routed to a pipeline for sale.¹³⁹

Figure 27: Pneumatic Controller Evaluation Flowchart

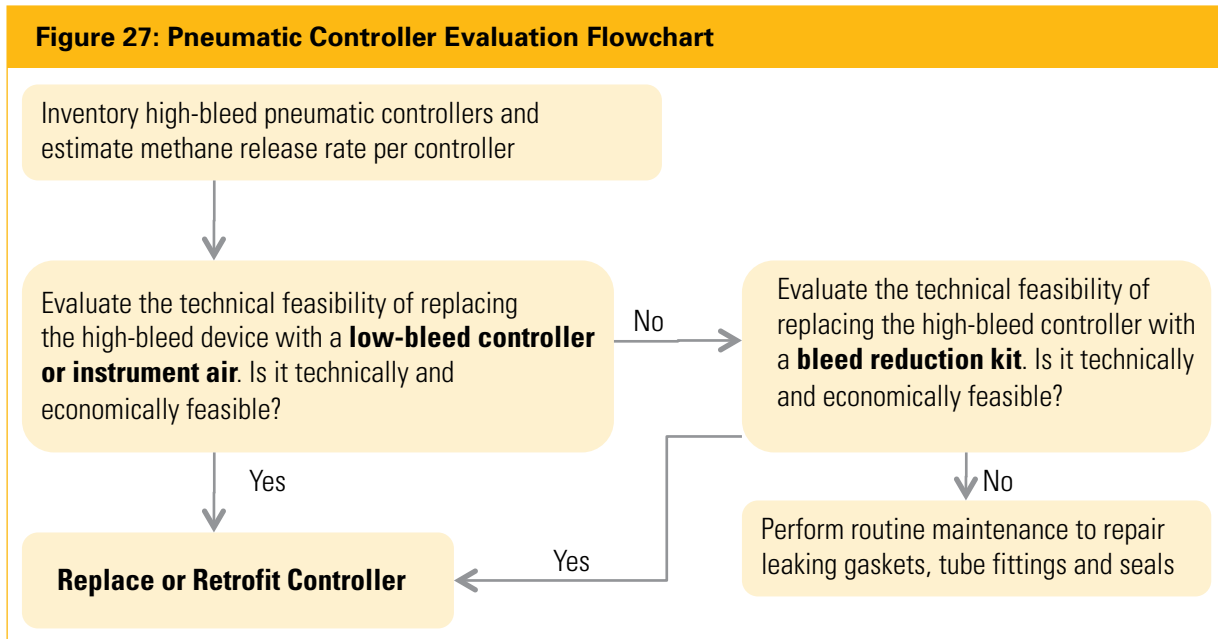

4.7.5 Additional Benefits

Upgrading pneumatic controllers to use instrument air increases operational efficiency, system-wide performance, and reliability. It also improves monitoring of gas flow, pressure, and liquid levels. Excess instrument air can be used for other equipment (e.g. pumps and compressor starters).

4.7.6 Limitations and Evaluation

The EPA estimates that 80 percent of all high-bleed controllers can be retrofitted or replaced with low-bleed equipment, leaving 20 percent of the controller inventory not feasible for this technology.¹⁴⁰

Figure 27 provides a simplified evaluation flowchart to show the basic steps for evaluating replacement of a high-bleed to a low or no-bleed pneumatic controller.

4.8 PIPELINE MAINTENANCE AND REPAIR

Methane is typically vented into the atmosphere when a gas pipeline is repaired or replaced, or must be cut to install a new connection point. Typically an operator will isolate the pipeline section to be worked on by shutting pipeline valves on either side of the repair, replacement, or connection point. The gas contained in the piping section is typically vented into the atmosphere to eliminate a potential fire or explosion risk while work is completed on the piping.

Subject to a thorough safety evaluation, alternatives exist to mitigate methane release. These alternatives involve either re-routing gas to be burned as fuel or allowing work to be conducted on the pipeline while it is in operation.

During pipeline repair, methane gas venting can be mitigated by:

- Using hot tap connections
- Re-injecting gas into a nearby low-pressure fuel system,
- Using a pipeline pump-down technique to route gas to sales

4.8.1 Technology Description

Hot Tap: Hot tapping a pipeline allows an operator to make a connection to a pressurized piping system without causing any service interruption. Hot tapping is completed by first welding a branch fitting and permanent valve body onto the pipeline while the pipeline remains in service. Next, the hot tapping machine is installed on the valve body (Figure 28). The hot tap pipeline cutting tool is inserted through the valve body and used to cut into the pipeline while maintaining

Figure 28: Pipeline Hot Tapping Schematic

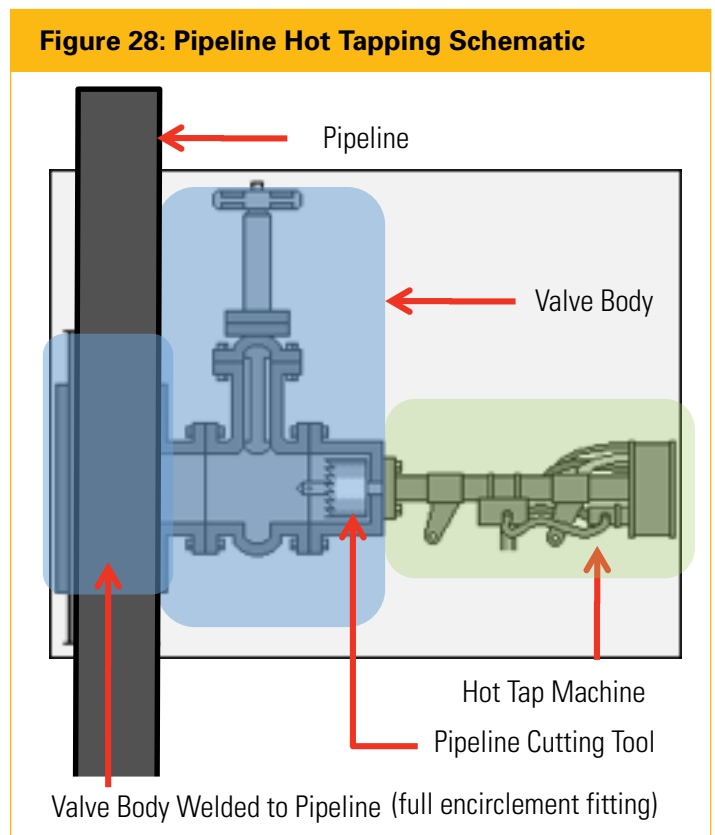

a complete seal between the valve body and the hot tap machine. This process does not allow any methane gas to escape. Once the pipeline wall is cut, the piece of pipe is removed along with the cutting tool by pulling both back through the valve body. The valve is closed and the hot tap machine is removed. Finally the branch line is connected and installed without releasing any methane into the environment.

Hot tapping is not a new technology; it has been in use for a number of years.¹⁴¹ However, hot tapping techniques and equipment have improved in quality, availability, and safety. More technicians and engineers are trained on safe use and operation, and necessary equipment is now available in the sizes typically used.

Re-injecting gas into a low pressure fuel system: In some cases, complete gas evacuation is required to safely repair, replace, or conduct maintenance on a pipeline section. Rather than venting methane to the atmosphere, an operator can de-pressure the pipeline to a nearby low pressure fuel system. Some pipelines are initially designed and installed with a bypass connection from the high pressure pipeline to a lower pressure fuel gas system. If a permanent bypass connection does not exist, a temporary bypass connection can be installed.

Pipeline pump-down technique: Gas can be removed from the pipeline by using in-line compressors along, or in sequence with, portable compressors. As explained above, an operator often will isolate the pipeline section to be worked on by shutting in pipeline valves on either side of the repair, replacement, or connection point. The gas contained in the piping section is then vented into the atmosphere to eliminate a potential fire or explosion risk. Alternatively, in the pipeline pump-down technique, the operator only shuts in one valve (the upstream valve), which stops any new gas from entering the pipeline section to be worked on. Then gas is removed from the pipeline section by running an in-line compressor located downstream of the repair section. This technique will not completely remove all the gas in the pipeline section, but may reduce the gas pressure or concentration to a level that is safe for some repairs (Figure 29A).

Use of a portable compressor, alone or in addition to an existing in-line compressor, can remove up to 90 percent of the gas in the pipeline segment because portable compressors have a 5 to 1 compression ratio, compared to in-line compressors that are rated at 2 to 1.¹⁴² To use a portable compressor, there must be a valve manifold at the downstream pipeline location to temporarily install the compressor during the repair work (Figure 29B).

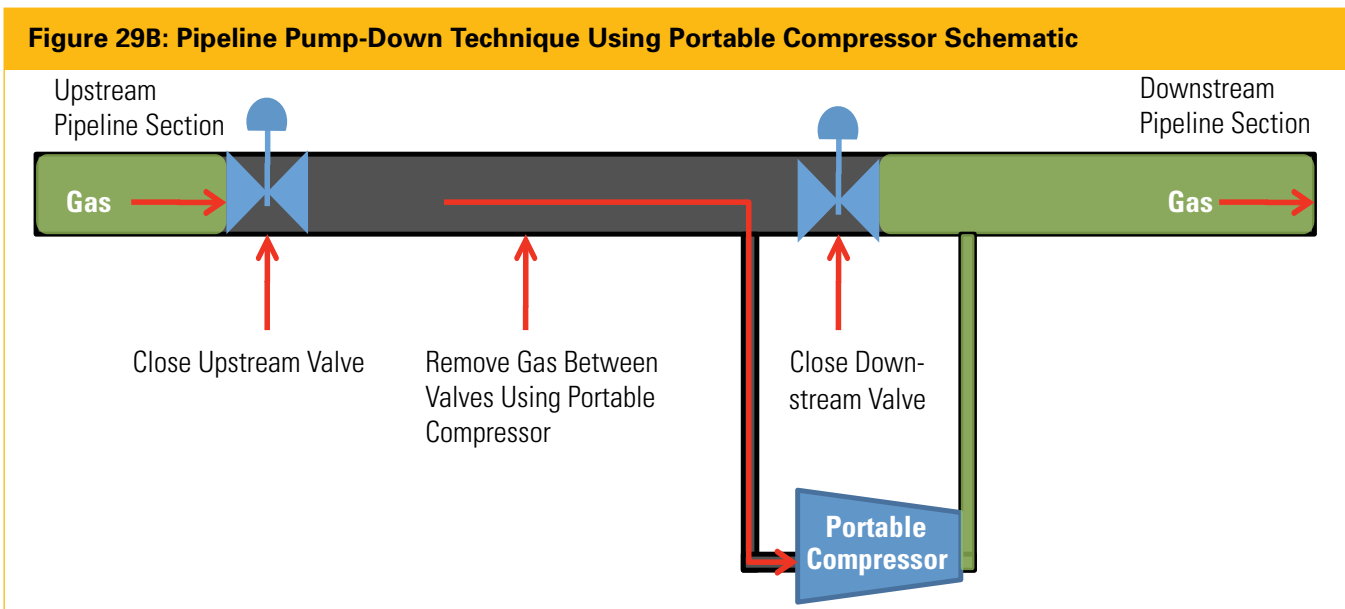
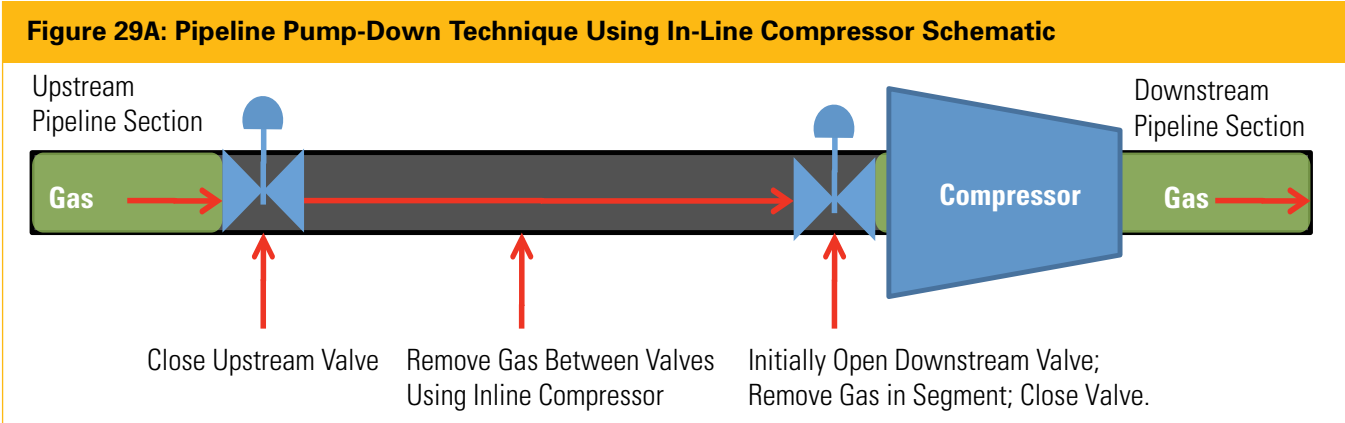

4.8.2 Opportunity

Reduction Target: 19 Bcf/year

The 2011 *Greenhouse Gas Inventory* estimates that routine maintenance and pipeline upsets resulted in 19 Bcf/year of methane vented into the atmosphere.¹⁴³

For a pipeline ranging from 4 to 18 inches in diameter and operating between 100 and 1,000 psig, the EPA estimates that up to 2,000 Mcf of methane gas is vented when a pipeline is blown down to make a new connection, and 6,000 Mcf is vented when replacing pipe.¹⁴⁴ The amount of gas contained in the pipeline section will be a function of pipeline size, pipeline length between isolation valves, and gas pressure. Thus, gas venting rates and volumes will vary substantially.

4.8.3 Proposed EPA Regulations

The EPA's proposed NSPS and existing air toxics standards do not include pipeline maintenance and repair as a means to control methane. NRDC recommends that the EPA require methane control during maintenance and repair where safe and feasible.

4.8.4 Profit

Use of a hot tap tool prevents venting gas into the atmosphere, allowing that gas to reach market, and eliminates the cost of evaluating the pipeline to install the connection. Hot tap profitability will vary widely based on the pipeline size, flow rate and number of taps done in a period of time. However, in general the EPA reports that payback is short (less than one year) and the procedure is profitable.¹⁴⁵

The EPA estimated that the capital cost of installing a

low pressure piping bypass to re-inject gas during a pipeline blowdown into a low-pressure fuel system is less than \$1,000.¹⁴⁶

The pipeline pump-down technique is most profitable for higher pressure, higher volume pipelines with existing in-line compressors, or where valve manifolding exists to easily connect a portable compressor.

Overall, use of in-line compressors to remove gas from a pipeline during a pipeline pump-down technique is very profitable because there is no initial investment or rental costs, and payback is essentially immediate. If portable compressors are required, economics will vary and will require a site-specific evaluation. Still, this procedure is typically profitable, with a short payout.¹⁴⁷ Gas collected by the compressors can be routed to a gas sales line.

4.8.5 Additional Benefits

Continued operation of a pipeline during repair, maintenance, and installation of new connections eliminates disruption to gas service.

4.8.6 Limitations and Evaluation

The use of hot tap equipment and techniques requires a safety review and qualified personnel to safely operate the equipment, and there are some cases where use of hot tapping equipment is not safe or recommended. In these cases, advice can be sought from corporate health, safety, and environment experts to recommend alternate ways to avoid methane venting. Some repair, replacement, and pipeline connection plans require complete gas removal from the pipeline and a full purge to ensure the safety of personnel.

Figure 30 shows the basic steps for evaluating options to mitigate methane release from a pipeline during maintenance and repair work.

Figure 30: Pipeline Maintenance and Repair Evaluation Flowchart

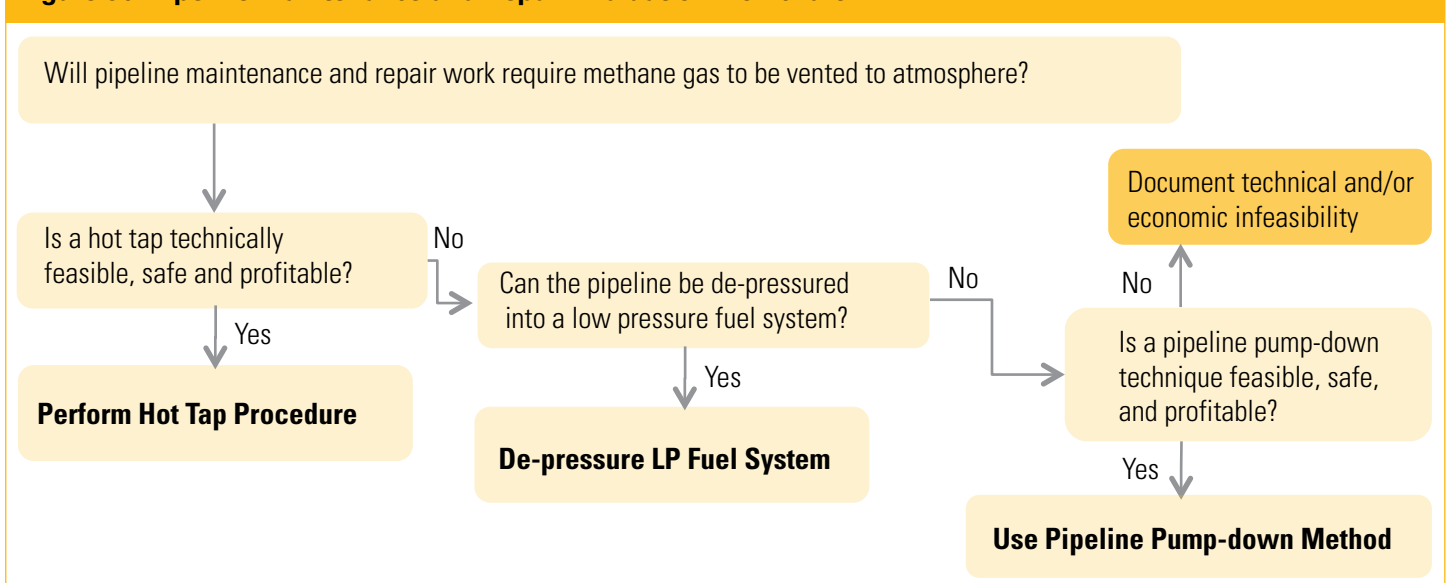

4.9 VAPOR RECOVERY UNITS (VRUs)

Crude oil and condensate tanks that vent to atmosphere emit methane through three different mechanisms: flashing losses, working losses, and standing losses. To avoid methane emissions, a vapor recovery unit can be installed on the tank to capture methane gas for sale or to be used as fuel.

4.9.1 Technology Description

When liquid petroleum and natural gas are produced from a well, they are processed through a separator to partition oil, gas, and water. Oil, condensate, and gas are sold to market. Water is either re-injected or handled as waste.

Liquid petroleum is sometimes stored in tanks prior to delivery to a pipeline or other transportation method. Gas liquids (condensate), in some cases, are produced and collected in a tank. When oil leaves the last phase of separation, some amount of methane gas is still trapped in the oil; the amount of methane is dependent on the last-stage separator pressure.

Since the separator pressure is higher than the pressure in a crude oil or condensate tank, methane gas will escape from the crude oil or condensate during transfer into the tank. Liberation of natural gas is commonly referred to as “flashing” of natural gas from the oil. Flashed gas, typically, has a high BTU value and sales value.

Fewer flashing losses will be generated from an oil storage tank if a facility reduces the operating pressure of the low-pressure separator or heater equipment just upstream of the oil storage tank. In these cases, less gas will be routed to the tanks. These optimizations can be accomplished by adjusting operating pressures with minimal capital and operational costs.

Figure 31: Vapor Recovery Unit



© Remediation Services International

Once crude oil and condensate are in the tank, they will continue to release methane gas when tank contents are agitated (working losses), which typically occurs during filling and removal of oil or condensate from the tank, and through standing losses during seasonal and daily temperature and pressure changes.

Vapor recovery units can typically capture up to 95 percent of the methane that would ordinarily be vented to atmosphere. Figure 31 shows vapor recovery equipment. Captured methane gas can be sold or used as fuel. Figure 32 is a schematic showing the typical equipment configuration needed for a vapor recovery system.

For sites where electric power is available, the EPA recommends conventional rotary or screw type compressor vapor recovery units. For sites without electric power, an

Figure 32: Vapor Recovery Unit Schematic

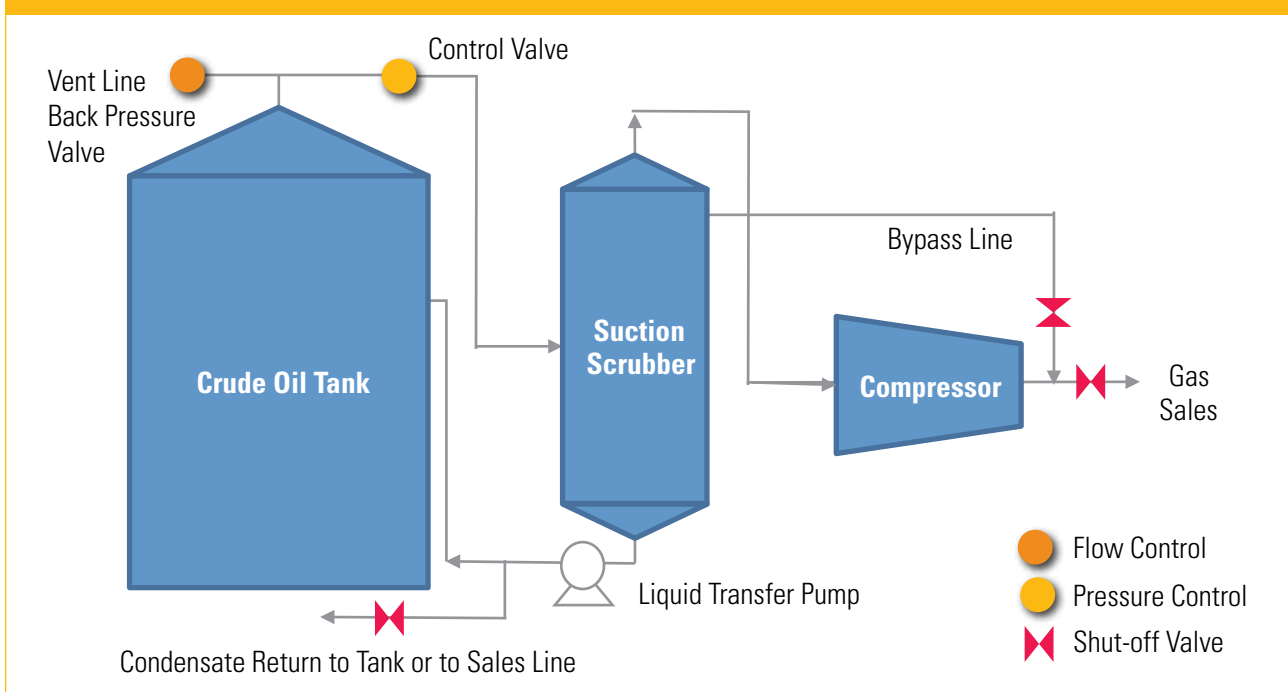

© M.A. Goodyear, A.L. Graham et al. Vapor Recovery of Natural Gas Using Non-mechanical Technology

ejector vapor recovery unit can be used if there is a high-pressure compressor with spare capacity.¹⁴⁸

TotalFinaElf E&P USA, Inc. reports that it recovered \$334,000 in gas per year from its El Ebanito O&G facility tanks in Starr County, Texas using the Venturi Jet Ejector System (patented by COMM Engineering).¹⁴⁹ Patented by Hy-Bon Engineering, the Vapor Jet System is another option if there is produced water available at the site to operate the system. A small centrifugal pump forces water into a Venturi jet, creating a vacuum effect to move low-pressure gas to a gas sales line or fuel use intake point.

If gas is collected in the vapor recovery units, it must be at sufficient pressure to enter the intended gas pipeline or fuel system. If this is not the case, additional compression is required at an additional cost.

4.9.2 Opportunity

Reduction Target: 21 Bcf/year

The 2011 *Greenhouse Gas Inventory* estimates that storage tanks vent approximately 21 Bcf/year of methane to the atmosphere.¹⁵⁰ Some crude oil tanks are required—by EPA and state regulation—to install vapor recovery units, however many smaller tanks do not have vapor recovery units installed.

4.9.3 Proposed EPA Regulations

The EPA's proposed NSPS for storage vessels would require at least 95 percent of VOC reductions for new and modified storage vessels.¹⁵¹ These requirements would apply to vessels with a throughput equal to or greater than one barrel of

condensate per day or 20 barrels of crude oil per day, which are equivalent to VOC emissions of about 6 tons per year.¹⁵¹ Controls would include either the installation of a VRU or the use of a combustion device. At the same time, the EPA is proposing revised air toxics standards for storage vessels. The standards would apply to new and modified sources as well as existing sources. The EPA is proposing a 95 percent HAP reduction requirement, which would also reduce VOC emissions at these sources by 95 percent. In order to avoid duplication in compliance requirements (monitoring, recordkeeping, and reporting), the EPA is proposing that sources which are subject to the NESHAPs requirements would not be subject to NSPS requirements.

The EPA estimates that the proposed NSPS and NESHAPs regulations would reduce methane emissions from storage tanks by about 0.52 Bcf/year, or just under 3 percent of the emissions from this source, because the proposed rules would not apply to most of the uncontrolled tanks currently in operation.

NRDC recommends that the EPA's proposed regulations be strengthened by reducing the threshold for emission control on smaller tanks (e.g., by aggregating small tanks into a battery of tanks and considering emissions of the entire battery). The EPA should also require emissions reductions from produced water tanks, and require 98 percent control efficiency for VRUs (up from 95 percent).

4.9.4 Profit

The amount of profit from vapor recovery units will vary widely, based on site-specific parameters. The EPA's Methane to Markets program found that tank vapor recovery projects can be profitable (Table 6). Depending on size of the systems,

Table 6: Crude Oil Tank Vapor Recovery Unit (VRU) Economics

Financial Analysis for a Conventional VRU Project

Peak Capacity (Mcf/day)	Installation & Capital* Costs	O&M Costs (year)	Value of Gas** (year)	Annual Savings	Simple Payback (months)	Internal Rate of Return %
25	\$35,738	\$7,367	\$18,262	\$10,895	39	28%
50	\$46,073	\$8,419	\$36,524	\$28,105	20	60%
100	\$55,524	\$10,103	\$73,048	\$62,945	11	113%
200	\$74,425	\$11,787	\$146,097	\$134,310	7	180%
300	\$103,959	\$16,839	\$365,242	\$348,403	4	335%

Adapted from: EPA Natural Gas STAR, Reducing Methane Emissions with Vapor Recovery on Storage Tanks, Lessons learned from the Natural Gas STAR Program, Newfield Exploration Company, Anadarko Petroleum Corporation, Utah Petroleum Association, Interstate O&G Compact Commission, Independent Petroleum Association of Mountain States, March 23, 2010.

*Unit cost plus estimated installation of 75 percent of unit cost

** \$4.00 per Mcf x 1/2 peak capacity x 365 (original price as per report was \$6.22)

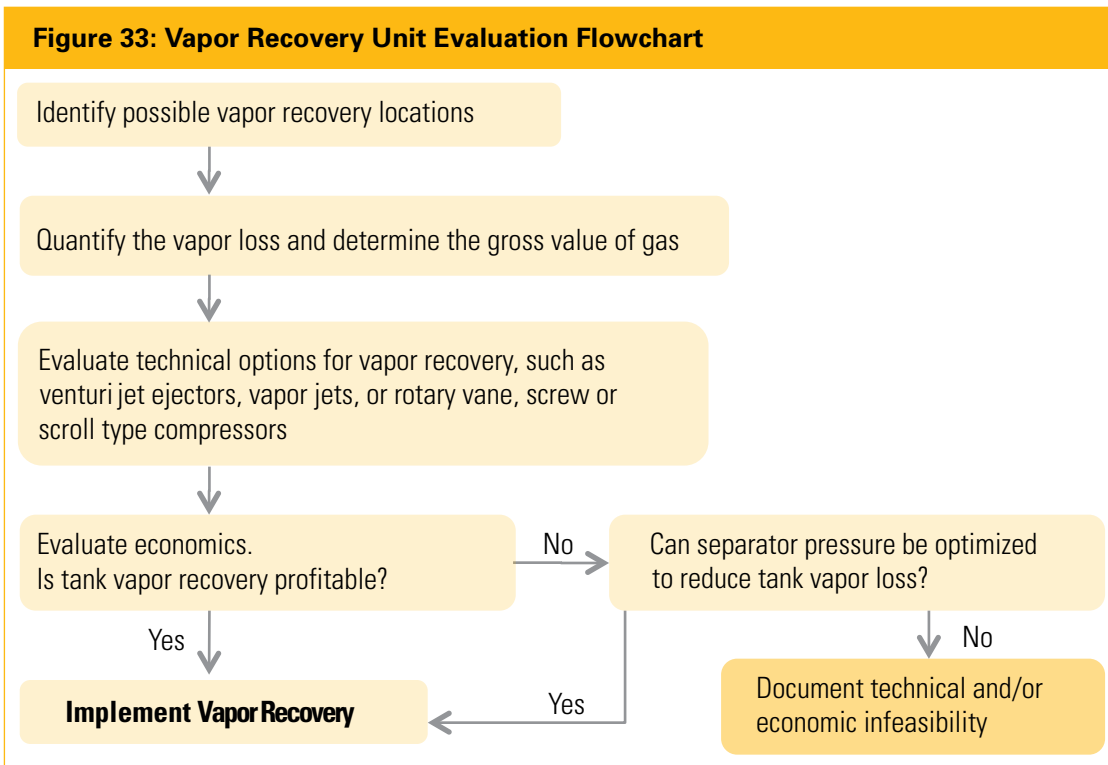

capital and installation costs range from \$36,000 to \$104,000, methane capture at between 5,000 and 91,000 Mcf/year, and profits are between \$4,000 and \$348,000. Additional detail is provided in Appendix A, Table A9. Payback periods range from a few months to about three years, depending on flow rate and scale of the unit.^{152,153}

Additional examples of tank vapor recovery profitability include:

- Anadarko reported netting \$7 million to \$8 million between 1993 and 1999 by installing more than 300 vapor recovery units.¹⁵⁴
- ConocoPhillips installed vapor recovery on nine tank batteries at a total cost of \$712,500. The company’s investment paid out within less than four months, earning \$189,000 per month thereafter.¹⁵⁵
- Chevron installed eight vapor recovery units on crude oil stock tanks in 1996. This investment paid out in less than one year.¹⁵⁶

If vapor recovery is not economic, an operator can consider minimizing the operating pressure of its low-pressure separators to reduce flashing losses, or the amount of methane vapors that are flashed off. For example, Devon Energy reported a savings of \$7,000 per year after optimizing operating pressures in its low-pressure separators, reducing the amount of methane vapors that are flashed off. The company reported that the “primary goal of the optimization

was to increase profits for the facility by putting more gas into the sales pipeline and to reduce emissions of methane with minimal costs to the facility.”¹⁵⁷

4.9.5 Additional Benefits

Vapor recovery units are commonly required in ozone non-attainment areas as lowest achievable emission rate (LAER), or in attainment areas as best available control technology (BACT). Therefore, VRU use to control methane will also have ozone mitigation benefits. Control of tank vent gases can also reduce emissions of HAPs, such as benzene, toluene, ethylbenzene, and xylenes, VOCs, and hydrogen sulfide.

The collection of methane and other gas vapors creates a safer working environment by reducing potentially combustible vapors at the work site.

4.9.6 Limitations and Evaluation

Care must be taken in VRU system design to avoid oxygen entrainment, because oxygen in the system can pose a corrosion and explosion hazard.¹⁵⁸

VRUs are appropriate for locations that have access to a gas pipeline or an opportunity to use the recovered methane for fuel gas. If this infrastructure does not exist, the technical and economic feasibility may be limited.

Figure 33 illustrates the basic steps for evaluating tank vapor recovery options.

Figure 34: Hand Held Infrared Camera



© Mine Safety Appliances Co.

Figure 35: Remote Methane Leak Detector



© Mine Safety Appliances Co.

4.10 LEAK MONITORING AND REPAIR

Methane gas leaks can occur from numerous locations at oil and gas facilities—valves, drains, pumps, threaded and flanged connections, pressure relief devices, open-ended valves and lines, and sample points—as gas moves through equipment under pressure. These leaks are called fugitive emissions.

Fugitive emissions from equipment leaks are unintentional losses of methane gas that may occur due to normal wear and tear, improper or incomplete assembly of components, inadequate material specifications, manufacturing defects, damage during installation or use, corrosion, or fouling.¹⁵⁹

Because methane is a colorless, odorless gas, leaks often go unnoticed. Historically, checks were typically performed on equipment components when they were first installed, using a soap bubble test or hand held sensor, to ensure the installation was leak tight. After installation, leaks were not typically monitored or repaired unless they became a significant safety hazard. For example, a significant gas leak would be repaired if area, building, or employee monitors set off alarms or if olfactory, audible, or visual indicators observed by facility employees identified the leak. Under these circumstances, the leaks had usually become an obvious safety concern. As a result, methane leaks at outdoor facilities and unmanned facilities often went undetected for long periods of time.

Today, an increasing number of operators are monitoring and repairing leaks at their facilities. Sometimes these programs are instituted voluntarily, other times they are required by the EPA, or state and local air quality control agencies. For instance, the EPA has leak detection and repair regulations for VOCs where facilities meeting certain specifications are required to survey for leaks and repair all detected leaks. A voluntary program, also undertaken by the EPA Natural Gas STAR program, is called Directed Inspection and Maintenance. In this program facilities identify leaks, and then prioritize and repair them based on cost-effectiveness.

Figure 36: Leaking Valve as shown by Infrared Gas Detector



© FLIR Systems, Inc.

4.10.1 Technology Description

Fugitive emission control is a two-part process that includes both a monitoring program to identify leaks and a repair program to fix the leak. Monitoring program type and frequency is a function of the type of component, and how the component is put to use. In most cases, monitoring programs can be intermittently scheduled at a certain frequency (e.g. monthly or quarterly) to identify leaking equipment. However, permanent leak sensors may be required to detect chronic leakers.¹⁶⁰

There are many different monitoring tools that can be used to identify leaks, including electronic gas detectors, acoustic leak detection systems, ultrasound detectors, flame ionization detectors, calibrated bagging, high volume sampler, end-of-pipe flow measurement, toxic vapor analyzers, and infrared optical gas detectors. A few of these methods are described in more detail to familiarize the reader with the availability of these tools and the ease of measurement capability. Once leaks are identified, the operator can evaluate what is causing the leak and develop a replacement or repair program to mitigate the problem. For example, a hand held infrared camera can be used as a

screening tool to detect emissions that are not visible to the naked eye. An infrared camera produces images of gas leaks in real-time. It is capable of identifying methane leaks, but cannot quantify the amount of the leak (Figure 34).

Remote methane leak detectors can detect methane leaks from as far away as 100 feet (Figure 35).

Infrared cameras produce photos that show methane gas leaks, like the leaking valve shown in Figure 36. Once a leak is identified, a more quantitative leak flow rate is needed, and other measurement devices such as high-flow samplers, vent-bag methods, and anemometers may be used.¹⁶¹ High-flow samplers capture the entire leak, measuring the leak rate directly for leaks up to 10 cubic feet per minute, providing leak flow rate and concentration data.

In 2007, TransCanada reported significant reductions in fugitive emissions by implementing an effective leak monitoring and repair program that included measurement of fugitive emissions using high flow samplers to identify the largest and most effective repairs.¹⁶²

Canadian experience with control of fugitive emissions at oil and gas facilities shows that:¹⁶³

- Most methane leaks are from components in gas service
- Older facilities have the highest leak rates
- About 75 to 85 percent of leaks are economic to repair
- The top 10 leaks at a facility generally contribute more than 80 percent of the emissions

The EPA has found that components in sweet gas service tend to leak more often than those in sour gas service, and a high frequency of leaks occurs from components in vibration, cryogenic, or thermal cycling service.¹⁶⁴

4.10.2 Opportunity

Reduction Target: 143 Bcf/year

The 2011 *Greenhouse Gas Inventory* estimates that the O&G industry's fugitive emissions are 143 Bcf/year.¹⁶⁵ Elimination or reduction of gas leaks retains more gas in the piping system for sale.

Most large gas processing plants are already subject to the existing NSPS regulations (40 CFR Part 60, Subpart KKK) and required to implement an LDAR program. However, most of the 457,000 miles of production gathering pipelines, and 302,000 miles of transmission pipelines in the United States and 384,000 meters have not been required to implement LDAR programs.¹⁶⁶

The 143 Bcf/year of fugitive emissions is largely uncontrolled today. Fugitive emissions management is an ongoing commitment, not a one-time initiative. The potential for fugitive equipment leaks will increase as facilities age. Successful fugitive emission control plans require trained personnel, emissions testing equipment, performance tracking systems, and corporate commitment.

4.10.3 Proposed EPA Regulations

The EPA's proposed NSPS regulations would lower leak detection thresholds at gas processing plants.¹⁶⁷ The EPA's proposed NSPS regulations would reduce methane emissions through leak detection and repair by about 0.1 Bcf/year, less than 0.1 percent of the methane emissions from equipment leaks.

Based on the EPA's reported leak monitoring and repair profitability, NRDC recommends that more LDAR programs can and should be required by the EPA. Facilities in all sectors, including the production, transmission and distribution sectors should undertake LDAR programs. Best management practices such as optimizing processes should be used in tandem with LDAR programs. Not all devices that detect VOCs can detect methane, so facilities should specifically employ equipment and processes that can detect methane, such as infrared laser detectors.

4.10.4 Profit

In 2009, the EPA examined the profitability of repairing equipment leaks at oil and gas facilities through a Directed Inspection & Maintenance program.¹⁶⁸

EPA *Lessons Learned* documents for both gas processing plants and compressor stations show the average cost of repair was between \$26,000 and \$59,000 per year per facility.^{169,170} Methane captured through these programs averaged 30,000 and 87,000 Mcf/year. For gas processing plants, leak screening and monitoring cost about \$32,000 annually per plant. At both gas processing plants and compressor stations, the investments are profitable generating as much as \$314,000 in profit per facility, with payback periods of just a few months. Additional detail is shown in Appendix A, Table A10.

4.10.5 Additional Benefits

The EPA has found that fugitive emission control provides numerous benefits including: reduced maintenance costs and downtime, improved process efficiency, a safer work environment, a cleaner environment, and resource conservation.¹⁷¹ Leaking gases may also include toxic air pollutants known to harm human health.

4.10.6 Limitations and Evaluation

There are no major limitations or barriers to implementation of a leak monitoring and repair program.

A simplified evaluation flowchart (Figure 37) is provided to show the basic steps for evaluating leak monitoring and repair.

Figure 37: Leak Monitoring and Repair Evaluation Flowchart

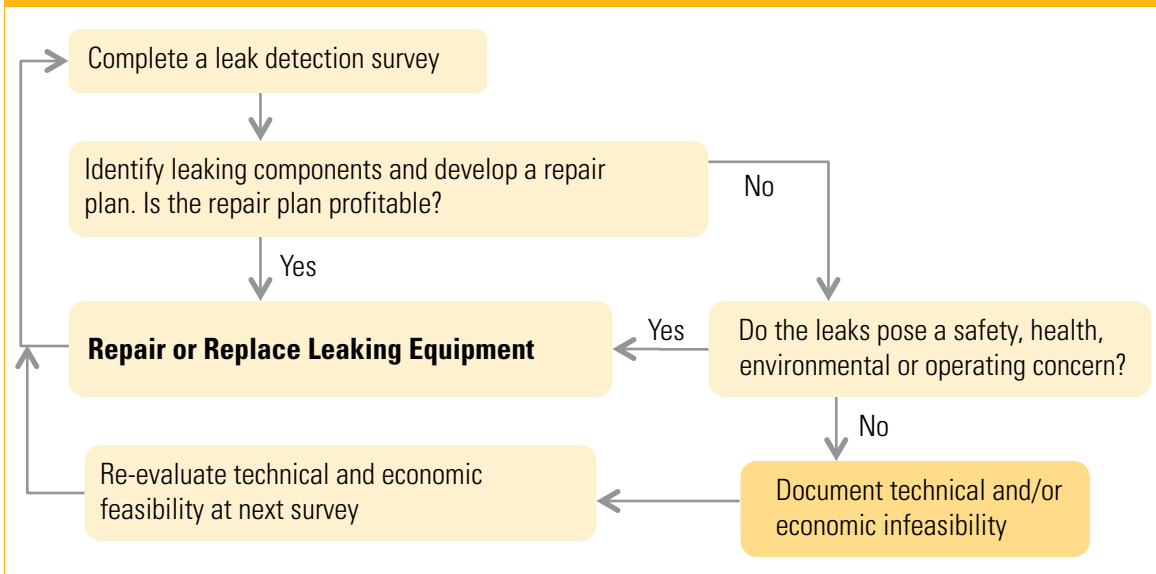

5. CONCLUSION AND POLICY RECOMMENDATIONS

The technologies discussed in this report can be used to reduce significant amounts of methane emissions from the oil and gas production, processing, and transmission sector, while generating significant profits for the O&G Industry. NRDC recognizes that some companies have voluntarily implemented methane controls. Mandatory methane control regulations will be needed for companies that have not updated business-as-usual practices, embraced a culture of environmental responsibility, or chosen to voluntarily invest even in profitable methane control technologies. Through these steps methane can be kept out of the atmosphere and the health and safety of Americans can be improved.

NRDC supports establishing a fully effective system of safeguards to ensure that natural gas is produced, processed, stored, and distributed in a way that ensures protection of our water, air, land, climate, human health, and sensitive ecosystems (For more information on NRDC's position on natural gas and fracking, go to <http://www.nrdc.org/energy/gasdrilling/>). The use of natural gas in our homes, power plants, and industry also must be as efficient as possible. Americans do not have to trade clean water and clean air for increased natural gas supplies. The O&G industry can and should adopt the methane capture technologies discussed in this report, which are technically proven, commercially available, and profitable.

Given our country's growing reliance on natural gas and methane's strong link to global warming, methane emissions should be controlled to the maximum extent possible. It is fortunate that more than 80 percent of methane emissions can be captured with the technologies highlighted in this report and yield billions of dollars in revenues through sale of the captured methane. Under these circumstances, there is a compelling case for companies to be required to adopt the best methane capture practices as soon as possible, and for government at all levels to take a far more active role in addressing market failures and requiring producers to adopt best practices.

Taking these considerations into account, several policy options can reduce methane emissions across the natural gas industry nationwide. NRDC recommends adoption of the policies outlined below:

- The EPA's proposed NSPS and air toxics standards provide an important starting point for the reduction of air pollutants from O&G operations, with substantial methane co-benefits. Still, there are key ways in which

these regulations can be improved, with robust mandates needed, as voluntary programs have proven insufficient. Federal regulations to control methane emissions would need to be adopted by states through their State Implementation Plans. The EPA should:

- Regulate methane directly
- Expand its proposal to include emission reduction requirements for existing sources that are the main contributors to VOC and methane emissions from the oil and natural gas industry. States would then be required to adopt methane leakage control measures for existing sources through their State Implementation Plans
- Ensure coverage of all major methane emission sources for which controls are feasible, including coalbed methane wells and oil wells
- Strengthen standards where possible. For example, the EPA should raise standards for tank and dehydrator emissions reductions
- Strengthen required procedures where possible. For example, the EPA should complement its Leak Detection & Repair program by requiring that best management practices be implemented, including process optimization and conducting more frequent leak surveys
- The EPA should continue to improve its mandatory greenhouse gas emissions reporting program for the O&G industry so that methane emission sources can be better identified, and opportunities for reductions can be better targeted. Also, the EPA should provide a more detailed breakdown by source of methane emissions reductions achieved through the Natural Gas STAR program.

- The EPA's Natural Gas STAR program's voluntary framework has encouraged companies to reduce methane emissions and document their reduction activities. Through Natural Gas STAR, techniques to reduce methane emissions have been tried and tested by some companies. Still, many effective reduction technologies have not been widely adopted by industry. To achieve significant industry-wide reductions, the most successful practices documented by the Natural Gas STAR program need to become mandatory through EPA's regulatory programs such as NSPS and NESHAPs. However, Natural Gas STAR should still play an important role in driving continued improvements that in turn can inform future revisions of EPA standards.
- Federal land management agencies, such as the Bureau of Land Management, should exercise their authority and responsibility to control methane waste from oil and gas lease operations on federal lands. Land management agencies should:
 - Modernize agency policies to prevent waste of methane resources through deployment of all technically and economically viable methane emission reduction technologies and practices, and to establish acceptable performance levels (i.e., levels of emissions beyond which production of mineral resources should be prohibited)
 - Evaluate methane emission risks and reduction opportunities as both a climate and waste problem
- through planning and environmental reviews before committing resources to development
 - Not commit resources to development where methane emissions cannot technically or economically be abated within acceptable performance levels
 - Where lands are committed to development, mandate specific methane reduction technologies and practices appropriate to the particular production field or geologic formation under consideration
 - Shift the burden to oil and gas lessees and operators to demonstrate, before drilling permits are approved, that all reasonable and prudent methane emission prevention technologies and practices will be used, with land management agencies retaining full authority to mandate specific methane reduction technologies and practices or levels of performance
- States should require the use of methane control technologies. Several gas-producing states have already required methane pollution reduction measures to protect air quality and public health, mostly for large emission sources or in areas of concentrated development. These states, including Colorado, Wyoming, and Montana, provide a good start and model for action by other states and by federal agencies. Exceptions to these rules should be as narrow as possible.

APPENDIX A

The tables in Appendix A provide a detailed economic summary of the 10 methane control technologies. A brief economic summary was also provided in Table 4. The economic analysis in this appendix is presented in a manner that facilitates a ready comparison among reports from various sources. Blank cells indicate insufficient data to compute values.

Where applicable, the economics of the technologies are also compared with the EPA's estimates from its proposed NSPS rulemaking. However, NRDC and other environmental organizations are concerned about potential deficiencies in the EPA's cost-benefit estimates of methane control technologies.¹⁷² Therefore, NRDC has not utilized the EPA's NSPS estimates to inform the range of costs and benefits in this report, and instead has relied heavily on industry data and the EPA's Natural Gas STAR and Methane to Markets data.

Each line in the tables below represents a different data source or a different treatment within a source. Each line includes the source and year of the data (corresponding to the sources cited in the body of this report). The "Type" column describes any feature of the data, such as whether it was an upper bound or an average or based on a particular kind of technology. The next column specifies, if available, the number of devices (or wells or installations) from which an average was obtained. The remaining columns discuss the economics of the technologies.

The terms used in the tables are consistent with common industry and accounting practices:

- **Total investment:** Total costs of implementing a technology; typically up-front costs, excluding ongoing operating and maintenance expense.
- **Annual investment expense:** Effective investment cost spread out over the useful life of the investment. In a few tables, for simplicity this is just depreciation expense, using simple depreciation with no salvage value. In other tables where more information is available, this includes joint depreciation and interest expenses using a capital recovery factor.
- **O&M expense:** Operating and maintenance expense for technology deployment.
- **Total annual expense:** Annual investment expense plus O&M expenses.
- **Revenue from NG:** Revenue from the sale of natural gas, obtained by multiplying gas sales volume and price.
- **Other revenue:** Revenues other than from the sale of natural gas.
- **O&M savings:** Operating and maintenance savings from technology deployment.
- **Total revenue plus savings:** Sum of revenue and any O&M savings.
- **Payout:** Period (in years) in which initial investment is paid back (i.e., total investment divided by total revenues, plus O&M savings, less O&M costs per year).
- **Operating profit excluding depreciation:** Total revenues, plus O&M savings, less O&M costs, excluding depreciation; akin to EBITDA (earnings before interest, taxes, depreciation and amortization). This is sometimes referred to as "profit" in the text.
- **Operating profit:** Total revenues, plus O&M savings, less O&M costs, less depreciation (approximated to annual investment expense, as above); akin to EBIT (earnings before interest and taxes).

Table A2: Cost-effectiveness of plunger lift systems

Source	Year	Type	# installations	Total investment	\$	#	\$ / yr	Annual investment expense	Mcf / yr	\$ / Mcf	Volume of saved NG	Price of NG	Revenue from NG	O&M savings per year ^a	Total revenue plus savings per year	Years	Payout	Operating profit (ex depr) per year	\$ / yr	Operating profit per year	\$ / yr
EPA Lessons Learned ¹⁸⁵	2010	Min		2,600			520 ^b	4,700	4.00	18,800	10,900	29,700	0.09	29,700	29,180						
EPA Lessons Learned ¹⁸⁵	2010	Max		10,400			2,080	18,250	4.00	73,000	10,900	83,900	0.12	83,900	81,820						
EPA Lessons Learned ¹⁸⁵	2010	Simple Avg.		6,500			1,300	11,475	4.00	45,900	10,900	56,800	0.11	56,800	55,500						
Mobil Oil ¹⁸⁶	1997	Avg.	19					640	4.00	2,561		2,561		2,561							
BP ^{186,187}	2007	Avg.	2,200					1,424	4.00	5,696					7,045						
Amoco ¹⁸⁸	2006	Avg.	1,177	13,000			2,600	13,167	6.00	79,000	24,000 ^c	103,000	0.13	103,000	100,400						

^a Operational savings here includes maintenance costs less savings such as chemical treatments.

^b Assumes lifetime of five years for all examples, uses simple depreciation.

^c Includes savings from avoided electricity, well workovers and chemical treatments.

Table A3: Cost-effectiveness of TEG dehydrator controls

Source	Year	Type	# devices	Total investment	\$	#	\$ / yr	Annual investment expense	O&M expense per year	Total expense per year	Mcf / yr	Volume of saved NG	Price of NG	Revenue from NG	Total revenue plus savings per year	Years	Payout	Operating profit (ex depr) per year	\$ / yr	Operating profit per year	\$ / yr
EPA NG STAR ^{188,190}	2005	Flash tank separator		5,000			1,000 ^b		100	1,000	3,650	4	14,600	14,600	14,600	0.34	14,600	13,600			
EPA NG STAR ^{188,190}	2005	Optimizing glycol circ. Rate									18,250	4	73,000	73,000	73,000			73,000			
EPA NG STAR ¹⁹¹	2007	Rerouting glycol skimmer gas		1,000			200	100	300	300	7,665	4	30,660	30,660	30,660	0.03	30,560	30,360			
EPA NG STAR ¹⁹²	2007	Installing electric pump		7,000 ^b			1,400		1,400	1,400	5,000 ^c	4	20,000	20,000	20,000	0.35	20,000	18,600			
EPA NG STAR ¹⁹³	2005 - 07	All four above	4	13,000			2,600	100	2,700	2,700	34,565	4	138,260	138,260	138,260	0.09	138,160	135,560			

^a Assumes lifetime of five years for all examples, uses simple depreciation.

^b Approximate average of a range of costs from \$1,400 to \$13,000.

^c Conservative estimate based on the EPA range (360 Mcf/year to 36,000 Mcf/year).

Table A4: Cost-effectiveness of desiccant dehydrators

Source	Year	Type	#	\$	\$ / yr	Mcf	\$ / Mcf	\$ / yr	\$ / yr	O&M savings per year	Total revenue plus savings per year	Years	\$ / yr	Operating profit (ex depr) per year	Operating profit per year
EPA NG STAR ¹⁹⁴	2009	Avg.		16,000	3,200 ^a	1,000	4	4,000	2,000	6,000	6,000	2.67	6,000	6,000	2,800
BP ¹⁹⁵	2007	Avg.	858									“immediate”			3,147 ^b

^a Assumes lifetime of five years, uses simple depreciation.

^b Based on reported profit of \$27 million. Assumes a lifetime of 10 years. \$3,147 is the operating profit per device per year (including annual investment expense) over the period of 10 years.

Table A5: Cost-effectiveness of replacing wet seals in centrifugal compressors with dry seals

Source	Year	Type	#	\$	\$ / yr	Mcf	\$ / Mcf	\$ / yr	Revenue from NG	O&M savings per year	Total revenue plus savings per year	Years	\$ / yr	Operating profit (ex depr) per year	Operating profit per year
EPA Lessons Learned ¹⁹⁶	2006	Avg.		324,000	46,129 ^a	45,120	4	180,480	102,400	282,880	282,880	1.15	282,880	282,880	236,751
EPA NG STAR ^{197,198}	2006	Max (savings)		324,000	46,129	100,000	4	400,000 ^b	120,000 ^c	520,000	520,000	0.62	520,000	520,000	473,871
Petroleos Mexicanos ¹⁹⁹	2008	Avg.				35,000	4	140,000		140,000 ^d	140,000 ^d			140,000 ^d	
Targa ²⁰⁰	2006	Avg.		90,000	12,814					300,000	300,000	0.38 ^e	300,000	300,000	287,186

(EPA NSPS TSD estimates below not utilized to inform the range of costs and benefits in this report; only provided for completeness)

EPA – NSPS TSD ²⁰¹	2008	Processing		75,000 ^e	10,678 ^f	11,527 ^g	4	46,108	88,300	134,408	134,408	0.56	134,408	134,408	123,730
EPA – NSPS TSD ²⁰¹	2008	Trans. / Storage		75,000	10,678	6,372 ^g			88,300	88,300	88,300	0.85	88,300	88,300	77,622
EPA – NSPS TSD ²⁰¹	2008	Simple avg.		75,000	10,678	8,949		23,054	88,300	111,354	111,354	0.67	111,354	111,354	100,676

^a For annual investment expense including joint depreciation and interest expenses, assumes similar lifetimes and discount rate as in the EPA’s NSPS estimates.

^b Illustrative high-end estimate of natural gas savings based on the range of savings from \$75,000 - \$400,000.

^c Average maintenance and operational savings of \$120,000 based on the range of savings of \$100,000 - \$140,000.

^d Average of 2 – 7 months.

^e The EPA reports this to be 1-3% of the total pipeline cost. This is the incremental cost of a compressor with a dry seal instead of one with a wet seal (EPA NSPS TSD, page 6-19).

^f The EPA assumes a 10-year lifetime and a 7% discount rate; here annual investment expense includes joint depreciation and interest expenses.

^g EPA NSPS TSD, page 6-20, Table 6-8; based on individual compressor emissions reductions in tons per year.

Table A6: Cost-effectiveness of replacing rod packing in reciprocating compressors

Source	Year	Type	#	\$	\$ / yr	Mcf	\$ / Mcf	Price of NG	Volume of saved NG	Revenue from NG	Total revenue plus savings per year	Years	Operating profit (ex depr) per year	Operating profit per year	
EPA Lessons Learned ²⁰²	2006	Avg.		6,480 ^a	2,493 ^b	3,460	4	4	3,460	13,840	13,840	0.47	13,840	11,347	
JPT ²⁰³	2008	Avg.		4,800 ^c	1,847 ^b	3,504 ^d	4	4	3,504 ^d	14,016	14,016	0.34	14,016	12,169	
(EPA NSPS TSD estimates below not utilized to inform the range of costs and benefits in this report; only provided for completeness)															
EPA – NSPS TSD ²⁰⁴	2008	Production		6,480	2,493 ^e	9 ^f	4	4	36	36	36	180.00	36	(2,457)	
EPA – NSPS TSD ²⁰⁴	2008	Gathering, Boosting		5,346	1,669 ^e	396 ^f	4	4	1,584	1,584	1,584	3.38	1,584	(85)	
EPA – NSPS TSD ²⁰⁴	2008	Processing		4,050	1,413 ^e	1,077 ^f	4	4	4,308	4,308	4,308	0.94	4,308	2,895	
EPA – NSPS TSD ²⁰⁴	2008	Transmission		5,346	1,669 ^e	1,257 ^f						NA	0	(1,669)	
EPA – NSPS TSD ²⁰⁴	2008	Storage		7,290	2,276 ^e	1,263 ^f						NA	0	(2,276)	
EPA – NSPS TSD ²⁰⁴	2008	Simple avg.		5,702	1,904	296	4	4	1,186	1,186	1,186	4.81	1,186	(718)	

^a Cost of replacing rod packing for four cylinders (as per EPA TSD estimate of average number of reciprocating compressor cylinders in the production sector, Table 6-2), at \$1,620 per cylinder.

^b For annual investment expense including joint depreciation and interest expenses, assumes similar lifetimes and discount rate as in the EPA's NSPS estimate for reciprocating compressors in the production sector, i.e., same capital recovery factor (EPA NSPS TSD Table 6-7 and page 6-16).

^c Cost of replacing rod packing for four cylinders (as per EPA TSD estimate of average number of reciprocating compressor cylinders in the production sector, Table 6-2), at \$1,200 per cylinder.

^d Multiplying estimated emissions savings as reported by sources by four, to account for savings from four cylinders.

^e The EPA annual investment expense estimates include joint depreciation and interest expenses, but uses slightly different capital recovery factors for different kinds of devices (EPA NSPS TSD Table 6-7 and page 6-16).

^f EPA NSPS TSD, page 6-15, Table 6-6; based on individual compressor emissions reductions in tons per year.

Table A7: Cost-effectiveness of replacing high-bleed pneumatic controllers with low-bleed pneumatic controllers

Source	Year	Type	#	\$	\$ / yr	Mcf	\$ / Mcf	\$ / yr	O&M savings per year	Total revenue plus savings per year	Years	Operating profit (ex depr) per year	Operating profit per year
EPA ^{205,206,207}	2005	Avg.		350 ^a		50 ^b	4	720	1,100	1,820	0.19	1,820	1,784
EPA Lessons Learned ²⁰⁸	2006	Avg.		275 ^d		39 ^b	4	500	50	550	0.50	550	511
BP ²⁰⁹	2005	Avg.	11,500	174 ^f		25 ^b	4	1,183	726	1,909	0.09	1,909	1,884
(EPA NSPS TSD estimates below not utilized to inform the range of costs and benefits in this report; only provided for completeness)													
EPA - NSPS TSD ²¹⁰	2008	Min		158		23 ^b							
EPA - NSPS TSD ²¹⁰	2008	Max		1,852		264							
EPA - NSPS TSD ²¹⁰	2008	Avg.		165		24	4	1,500		1,500	0.11	1,500	1,477

^a Based on incremental cost of fitting low-bleed devices instead of high-bleed devices, for all lines.

^b For annual investment expense including joint depreciation and interest expenses, assumes similar lifetimes and discount rate as in the EPA's NSPS estimates.

^c Based on average natural gas savings of 0.3 Mcf/day (as reported in sources).

^d Average of \$210 and \$340 per device.

^e Average of 50 and 200 Mcf/year.

^f Assumes half of replacement cost.

^g 11,500 wells saved 3.4 Bcf/year.

^h The EPA assumes a lifetime of 10 years and a discount rate of 7% (NSPS TSD page 5-16, 5-17); here annual investment expense includes joint depreciation and interest expenses.

ⁱ Using the average value of dollar savings (NSPS TSD page 5-16); calculated natural gas volume is consistent with TSD value quoted.

Table A8: Cost-effectiveness of replacing high-bleed pneumatic controllers with instrument- air pneumatic controllers

Source	Year	Type	#	\$	\$ / yr	\$ / yr	\$ / yr	\$ / yr	Mcf	\$ / Mcf	\$ / yr	Years	\$ / yr	\$ / yr	
			# devices	Total investment	Annual investment expense	O&M expense per year	Total expense per year	Total revenue plus savings per year	Volume of saved NG	Price of NG	Revenue from NG	Payout	Operating profit (ex depr) per year	Operating profit per year	
EPA NG STAR ^{211,212}	2005	Avg.		10,000	1,400 ^a	7,500 ^b	8,900	21,600	5,400	4	21,600	0.70 - 2.00 ^c	14,100	12,700	
EPA Lessons Learned ²¹³	2006	Avg.		60,000	8,500 ^a	17,700 ^b	26,200	80,000	20,000	4	80,000	0.96	62,300	53,800	
(EPA NSPS TSD estimates below not utilized to inform the range of costs and benefits in this report; only provided for completeness)															
EPA - NSPS TSD ²¹⁴	2008	Small		16,972	2,416 ^d	1,334	11,090 ^e	3,484	871	4	3,484	NA	(5,190)	(7,606)	
EPA - NSPS TSD ²¹⁴	2008	Med.		73,531	10,469	4,333	36,877	14,632	3,658	4	14,632	NA	(11,776)	(22,245)	
EPA - NSPS TSD ²¹⁴	2008	Large		135,750	19,328	5,999	80,515	40,644	10,161	4	40,644	NA	(20,543)	(39,871)	
EPA - NSPS TSD ²¹⁴	2008	Simple avg.		75,418	10,738	3,889	42,827	19,587	4,897	4	19,587	NA	(12,503)	(23,241)	

^a For annual investment expense including joint depreciation and interest expenses, assumes similar lifetimes and discount rate as in the EPA's NSPS estimates.

^b Includes both labor and operational costs such as electrical power (unlike EPA costs in same column).

^c Range between calculated value and reported value.

^d EPA assumes a 10-year life, and a 7% discount rate; here annual investment expense includes joint depreciation and interest expenses.

^e The total expense includes capital, labor and electrical power.

Table A9: Cost-effectiveness of installing vapor recovery units

Source	Year	Type	#	\$	\$ / yr	\$ / yr	\$ / yr	Mcf	\$ / Mcf	\$ / yr	Years	\$ / yr	\$ / yr	
			# devices	Total investment	Annual investment expense	O&M expense per year	Total expense per year	Volume of saved NG	Price of NG	Revenue from NG	Total revenue plus savings per year	Payout	Operating profit (ex depr) per year	Operating profit per year
EPA NG STAR ²¹⁵	2010	Small		35,738 ^a	3,924 ^b	7,367	11,291	4,566	4	18,262 ^c	18,262	3.28	10,895	6,972
EPA NG STAR ²¹⁵	2010	Med.		55,524	6,096 ^b	10,103	16,199	18,262	4	73,048	73,048	0.88	62,945	56,849
EPA NG STAR ²¹⁵	2010	Large		103,959	11,414 ^b	16,839	28,253	91,311	4	365,242	365,242	0.30	348,403	336,990
EPA NG STAR ²¹⁵	2010	Simple avg.		65,074	7,145 ^b	11,436	18,581	38,046	4	152,184	152,184	0.46	140,748	133,603
Anadarko ²¹⁶	1999	Avg.	300										4,167	
ConocoPhillips ²¹⁷		Avg.	9	79,167	8,692 ^b							0.33	252,000	243,308
Chevron ²¹⁸	1996	Avg.	8									<1		
(EPA NSPS TSD estimates below not utilized to inform the range of costs and benefits in this report; only provided for completeness)														
EPA – NSPS TSD ²¹⁹	2008	Avg.		98,186	10,780 ^d	9,367	20,147	291	4	1,164	1,164	NA	(8,203)	(18,983)

^a This includes capital cost and installation cost equal to 75% of the capital cost.

^b For annual investment expense including joint depreciation and interest expenses, assumes similar lifetimes and discount rate as in the EPA's NSPS estimates.

^c Scaled down from savings based on a historically higher natural gas price of \$6.22/Mcf.

^d EPA assumes a 15-year life and a 7% discount rate; here annual investment expense includes joint depreciation and interest expenses.

Table A10: Cost-effectiveness of leak monitoring and repair systems

Source	Year	Type	#	\$/yr	Total investment per year	O&M expense per year	\$/yr	Total expense per year	Mcf	Volume of saved NG	Price of NG	\$/Mcf	Revenue from NG	Total revenue plus savings per year	Payout	Years	\$/yr	Operating profit (ex depr) per year	\$/yr	Operating profit per year
EPA Lessons Learned ²²⁰	2003	Gas processing plants		59,000 ^a	32,000 ^b	91,000	86,500 ^c	4	346,000	0.19	314,000	255,000	91,400	314,000	0.19	314,000	255,000	91,400	314,000	255,000
EPA Lessons Learned ²²¹	2003	Compressor stations		26,200		26,200	29,400	4	117,600	0.22	117,600	91,400	117,600	117,600	0.22	117,600	91,400	117,600	117,600	91,400
Methane to Markets ²²²	2009	Valves		130			2,895	4	11,580	likely small		likely positive	11,580	11,580	likely small		likely positive			likely positive
Methane to Markets ²²²	2009	Connectors		10			3,482	4	13,928	likely small		likely positive	13,928	13,928	likely small		likely positive			likely positive
Methane to Markets ²²²	2009	Open ended lines		60			2,320	4	9,280	likely small		likely positive	9,280	9,280	likely small		likely positive			likely positive
Methane to Markets ²²²	2009	Simple avg.		67			2,899	4	11,596	likely small		likely positive	11,596	11,596	likely small		likely positive			likely positive
Canadian experience ²²³	2005	Avg.								small		positive			small		positive			positive

(EPA NSPS TSD estimates below not utilized to inform the range of costs and benefits in this report; only provided for completeness)

EPA - NSPS TSD ²²⁴	2008	Valves		18,529 ^d	incl. in total	34,608	1,060 ^d	4	4,241	4,241	NA	negative	4,241	4,241	NA	negative	30,366	negative	NA	(30,366)
EPA - NSPS TSD ²²⁴	2008	Connectors		9,991	incl. in total	25,622	515	4	2,061	2,061	NA	negative	2,061	2,061	NA	negative	(23,561)	negative	NA	(23,561)
EPA - NSPS TSD ²²⁴	2008	Pressure Relief Devices		101,820	incl. in total	40,372	160	4	639	639	NA	negative	639	639	NA	negative	(39,734)	negative	NA	(39,734)
EPA - NSPS TSD ²²⁴	2008	Open ended lines		12,280	incl. in total	26,200	693	4	2,772	2,772	NA	negative	2,772	2,772	NA	negative	(23,428)	negative	NA	(23,428)
EPA - NSPS TSD ²²⁴	2008	Simple avg.		35,655	incl. in total	31,700	607	4	2,428	2,428	NA	negative	2,428	2,428	NA	negative	(29,272)	negative	NA	(29,272)

^a Average of \$39,000 and \$78,000 for repairs annually.

^b Average of \$14,000 and \$50,000 for leak screening and measurement annually.

^c Average of 45,000 and 128,000 Mcf/year per gas plant.

^d Average of values from Tables 8-14, 8-15 and 8-17. Table 8-16 data was not included as that was only incremental cost data.

APPENDIX B: LIST OF ACRONYMS

API	American Petroleum Institute	MMtCO ₂ e	Million Metric tons of Carbon Dioxide equivalent
AQ	Air Quality	Mcf	Thousand standard cubic feet
BACT	Best Available Control Technology	MMcfd	Million standard cubic feet per day
BAT	Best Available Technology	NAAQS	National Air Ambient Air Quality Standards
bbbl	Barrels (equivalent to 42 gallons)	NESHAPs	National Emission Standards for Hazardous Air Pollutants
Bcf	Billion standard cubic feet	NO _x	Nitrogen Oxides
Bcf/year	Billion standard cubic feet per year	NPV	Net Present Value
BMP	Best Management Practices	NRDC	Natural Resources Defense Council
bopd	Barrels of oil per day	NSPS	New Source Performance Standards
BTU	British Thermal Unit	O&G	Oil & Gas
CDA	Concentrated Development Area	O&M	Operations & Maintenance
CO ₂	Carbon Dioxide	P&A	Plug & Abandonment
CO ₂ e	Carbon Dioxide equivalent	PM	Particulate Matter
DEG	Diethylene Glycol	PROs	Partnership Reduction Opportunities
DOE	U.S. Department of Energy	PRV	Pressure Relief Valve
E&P	Exploration & Production	psi	Pounds per square inch
EIA	U.S. Energy Information Administration	REC	Reduced Emission Completion
EPA	U.S. Environmental Protection Agency	scf	Standard cubic feet
GRI	Gas Research Institute	scfm	Standard cubic feet per minute
GWP	Global Warming Potential	TEG	Triethylene Glycol
HAPs	Hazardous Air Pollutants	tpy	Tons per year
HFCs	Hydrofluorocarbons	TREG	Tetraethylene Glycol
IPCC	Intergovernmental Panel on Climate Change	TSD	Technical Support Document
JPAD	Jonah-Pinedale Anticline Development Area	TWG	Technical Work Group
KWh	Kilowatt-hour	U.S.	United States
LAER	Lowest Achievable Emission Rate	VOCs	Volatile Organic Compounds
LDAR	Leak Detection & Repair	VRU	Vapor Recovery Unit
MEG	Ethylene Glycol	WCI	Western Climate Initiative
Mt	Metric ton (equivalent to 1.102 short tons)	WGA	Western Governors Association
MMt	Million Metric tons	WRAP	Western Regional Air Partnership

APPENDIX C : METHANE EMISSION SOURCE DETAIL

Table C1: Natural Gas System Methane Emission Sources

2009 NATURAL GAS SYSTEMS METHANE EMISSIONS			TECHNOLOGY OPTIONS COVERED IN PAPER	PERCENT OF OVERALL EMISSIONS
	Bcf	Bcf		%
PRODUCTION	464			
Well Completion, Workovers		68.26	No. 1 Green Completions	10%
Well Clean Ups (Low pressure gas wells)		236.47	No. 1 & 2 Green Completions and Plunger Lifts	33%
Dehydrator Vents		5.81	No. 3 & 4 Dehydrator Controls	1%
Reciprocating Compressors		4.33	No. 6 Improved Compressor Maintenance	1%
Pneumatic Controllers		62.92	No. 7 Low -Bleed or No-Bleed Controllers	9%
Pipeline Emissions		0.15	No. 8 Pipeline Maintenance and Repair	0%
Tank Venting		7.04	No. 9 Vapor Recovery Units	1%
Controlled Tank Vents		1.41		0%
Heaters		1.83		0%
Separators		5.85		1%
Vessel & Compressor Blowdown & Mishaps		0.29		0%
Compressor Starts		0.31		0%
Coal Bed Methane		3.59		1%
Engine & Turbine Exhaust		14.35		2%
Pump Emissions		17.18		2%
Offshore		15.67		2%
Fugitive Emissions		18.28	No. 10 Leak Monitoring and Repair	3%
Subtotal		463.73		
Subtotal of Emissions Controllable by the 10 Technologies		403.26		
PROCESSING	48			
Dehydrator Vents		1.39	No. 3 & 4 Dehydrator Controls	0%
Centrifugal Compressors Wet Seals		12.12	No. 5 Dry Seal Systems	2%
Centrifugal Compressors Dry Seals		1.28		0%
Reciprocating Compressors		19.93	No. 6 Improved Compressor Maintenance	3%
Pneumatic Controllers		0.10	No. 7 Low -Bleed or No-Bleed Controllers	0%
Pipeline Emissions		1.17	No. 8 Pipeline Maintenance and Repair	0%
Tank Venting		1.17	No. 9 Vapor Recovery Units	0%
Engine & Turbine Exhaust		8.64		1%
Acid Gas Removal Vents		0.65		0%
Pump Emissions		0.23		0%
Fugitive Emissions		1.67	No. 10 Leak Monitoring and Repair	0%
Subtotal		48.35		
Subtotal of Emissions Controllable by the 10 Technologies		37.54		

Table C1: Natural Gas System Methane Emission Sources (Continued)

TRANSMISSION				
	129			
Dehydrator Vents		0.34	No. 3 & 4 Dehydrator Controls	0%
Centrifugal Compressors Wet Seals		14.42	No. 5 Dry Seal Systems	2%
Centrifugal Compressors Dry Seals		0.98		0%
Reciprocating Compressors		51.25	No. 6 Improved Compressor Maintenance	7%
Pneumatic Controllers		13.93	No. 7 Low -Bleed or No-Bleed Controllers	2%
Pipeline Emissions		17.35	No. 8 Pipeline Maintenance and Repair	2%
Tank Venting		1.71	No. 9 Vapor Recovery Units	0%
Engine & Turbine Exhaust		13.71		2%
Fugitive Emissions		15.18	No. 10 Leak Monitoring and Repair	2%
Subtotal		128.87		
Subtotal of Emissions Controllable by the 10 Technologies		114.17		
DISTRIBUTION				
	74			
Pipeline Emissions		0.13	No. 8 Pipeline Maintenance and Repair	0%
Fugitive Emissions (Pipeline and Meter Leaks)		71.55	No. 10 Leak Monitoring and Repair	10%
Pressure Relief Valves & Mishaps (Dig-ins)		2.15		0%
Subtotal		73.84		
Subtotal of Emissions Controllable by the 10 Technologies		71.69		
TOTAL				
	715			
Total of Emissions Controllable by the 10 Technologies		627		88%
Other Emissions		88		12%

Source: EPA Inventory of U.S. Greenhouse Gas Emissions and Sinks: 1990-2009 Conversion: Gg/19.26=Bcf

Table C2: Petroleum System Methane Emission Sources

2009 PETROLEUM SYSTEM METHANE EMISSIONS			TECHNOLOGY OPTIONS COVERED IN PAPER	PERCENT OF TOTAL EMISSIONS
	Bcf	Bcf		%
PRODUCTION	75			
Pneumatic Controller		21.75	No. 7 Low -Bleed or No-Bleed Controllers	29%
Tank Venting		11.01	No. 9 Vapor Recovery Units	14%
Fugitive Emissions		37.33	No. 10 Leak Monitoring and Repair	49%
Combustion and Process Upsets		4.88		6%
Subtotal		74.97		
Subtotal of Emissions Controllable by the 10 Technologies		70.09		
TRANSMISSION	0			0%
REFINING	1			2%
TOTAL	76			
Total of Emissions Controllable by the 10 Technologies				92%
Other emissions				8%

Source: U.S. EPA 2011 Greenhouse Gas Inventory Conversion: Gg/19.26=Bcf

Endnotes

- 1 U.S. Energy Information Administration, Natural Gas Gross Withdrawals and Production, 2009 data. Available at http://www.eia.gov/dnav/ng/ng_prod_sum_dcu_NUS_a.htm.
- 2 U.S. EPA, Inventory of U.S. Greenhouse Gas Emissions and Sinks (1990-2009), April 15, 2011.
- 3 Operator is the term used throughout this report, and by industry, to refer to the companies that operate oil and gas fields, processing, and transportation equipment.
- 4 U.S. EPA, Recommended Technologies and Practices, 2011 data. Available at <http://www.epa.gov/gasstar/tools/recommended.html>. As of October 26, 2011, there were 95 technologies and practices listed that are known to be effective in reducing methane emissions from the O&G industry.
- 5 Government Accountability Office, Opportunities Exist to Capture Vented and Flared Natural Gas, Which Would Increase Royalty Payments and Reduce Greenhouse Gases, Washington D.C., October 2010; GAO-11-34.
- 6 U.S. EPA Greenhouse Gas Equivalencies Calculator, 2011. Available at <http://www.epa.gov/cleanenergy/energy-resources/calculator.html#results>.
- 7 U.S. EPA, Inventory of U.S. Greenhouse Gas Emissions and Sinks (1990-2009), April 15, 2011.
- 8 U.S. EPA, Oil and Gas Sector: New Source Performance Standards and National Emission Standards for Hazardous Air Pollutants Reviews, August 23, 2011; Federal Register, v. 76, no. 163 (76 FR 52738), EPA Docket No. EPA-HQ-OAR-2010-0505, FRL-9448-6. Available at <http://www.epa.gov/airquality/oilandgas/index.html>.
- 9 This report is not intended to be a critique of the proposed NSPS; NRDC's comments on EPA's NSPS proposal may be obtained from the regulatory docket, available at www.regulations.gov: NRDC and other environmental organizations, Comments on New Source Performance Standards and National Emission Standards for Hazardous Air Pollutants Reviews, Proposed Rule, November 30, 2011, EPA Docket No. EPA-HQ-OAR-2010-0505, Document ID No. EPA-HQ-OAR-2010-0505-4240. NRDC also recommends that the National Emission Standards for Hazardous Air Pollutants (NESHAPs) be strengthened. Comments on the EPA's NESHAPs proposal are available at Document ID No. EPA-HQ-OAR-2010-0505-4457.
- 10 Burcik, E.J., Properties of Petroleum Reservoir Fluids, 1979.
- 11 Encana Oil & Gas USA spokesperson, quoted in the Star-Tribune Energy Reporter, October 11, 2010: "[I]t is in our own interest to reduce emissions for a variety of reasons. One being it keeps the product we produce in the revenue stream."
- 12 American Petroleum Institute (API) and the International Petroleum Industry Environmental Conservation Association (IPIECA), Oil and Natural Gas Industry Guidelines for Greenhouse Gas Reduction Projects, March 2007, prepared by URS Corporation concludes on page 18 that "Companies and investors operate under capital constraints and the estimated financial returns of such GHG reduction projects may not justify diverting capital from other higher return or more strategic initiatives."
- 13 U.S. EPA, Inventory of U.S. Greenhouse Gas Emissions and Sinks (1990-2009), April 15, 2011.
- 14 Howarth, R. et al., Methane Emissions from Natural Gas Systems, Background Paper Prepared for the National Climate Assessment (reference number 2011-0003), February 25, 2012. Available at <http://www.eeb.cornell.edu/howarth/Howarth%20et%20al.%20--%20National%20Climate%20Assessment.pdf>
- 15 U.S. EPA, Inventory of U.S. Greenhouse Gas Emissions and Sinks (1990-2008), April 2010, page 3-47; U.S. EPA # 430-R-10-006.
- 16 U.S. EPA, Inventory of U.S. Greenhouse Gas Emissions and Sinks (1990-2008), April 2010, page A-144, Table A-118: 2008 Data and CH₄ Emissions (Mg) for the Natural Gas Production Stage.
- 17 U.S. EPA, Natural Gas STAR Program, Recommended Technologies and Practices, Wells. Available at <http://www.epa.gov/gasstar/tools/recommended.html>.
- 18 Devon Energy, U.S. EPA Natural Gas Star 2009 workshop presentation, slides 3 and 13. 6,300 Mcf = 11.4 Bcf / 1,798 wells.
- 19 U.S. EPA, Natural Gas STAR Program, Recommended Technologies and Practices, Wells. Available at <http://www.epa.gov/gasstar/tools/recommended.html>, and specifically <http://www.epa.gov/gasstar/documents/workshops/pennstate2009/robinson1.pdf>.
- 20 These data are consistent with the unconventional gas well completion and workover data presented in: U.S. EPA, Proposed Mandatory Reporting of Greenhouse Gases: Petroleum and Natural Gas Systems (Subpart W), Technical Support Document, 2009; Docket EPA-HQ-OAR-2009-0923.
- 21 U.S. EPA, Methane Emissions from the Natural Gas Industry, Project Summary, June 1997; EPA/600/SR-96/080.
- 22 U.S. EPA, Proposed Mandatory Reporting of Greenhouse Gases: Petroleum and Natural Gas Systems (Subpart W), Technical Support Document, 2009; Docket EPA-HQ-OAR-2009-0923: "... emissions estimates from the EPA/GRI Study are outdated and potentially understated for some emission sources."
- 23 U.S. EPA, Proposed Mandatory Reporting of Greenhouse Gases: Petroleum and Natural Gas Systems (Subpart W), Technical Support Document, 2009, page 23; Docket EPA-HQ-OAR-2009-0923.
- 24 U.S. EPA, Proposed Mandatory Reporting of Greenhouse Gases: Petroleum and Natural Gas Systems (Subpart W), Technical Support Document, 2009, Table 1 at page 8 and Appendix B, Docket EPA-HQ-OAR-2009-0923.
- 25 United States Federal Register, 75 FR 18621.
- 26 U.S. EPA, Inventory of U.S. Greenhouse Gas Emissions and Sinks (1990-2009), April 15, 2011.
- 27 U.S. EPA, Proposed Mandatory Reporting of Greenhouse Gases: Petroleum and Natural Gas Systems (Subpart W), Technical Support Document, 2009, Docket EPA-HQ-OAR-2009-0923.
- 28 Chambers, A.K. et al., DIAL Measurements of Fugitive Emissions from Natural Gas Plants and the Comparison with Emission Factor Estimates, 2006, found fenceline measurements of Canadian natural gas processing plants to be roughly an order of magnitude higher than estimated emissions of volatile organic compounds and benzene.
- 29 U.S. EPA, Natural Gas STAR Program. Available at <http://www.epa.gov/gasstar/>.
- 30 U.S. EPA, Methane to Markets, Reducing Emissions, Increasing Efficiency, Maximizing Profits, 2008. Available at www.epa.gov/gasstar/international/index.html.

- 31 “Demonstrated solutions” means the technology has been developed, tested, and is available on the market for purchase and installation.
- 32 U.S. EPA, Oil and Gas Sector: New Source Performance Standards and National Emission Standards for Hazardous Air Pollutants Reviews, August 23, 2011, Federal Register, v. 76, no. 163 (76 FR 52738), EPA Docket No. EPA-HQ-OAR-2010-0505, FRL-9448-6. Available at <http://www.epa.gov/airquality/oilandgas/index.html>.
- 33 NRDC does not accept these EPA estimates, as discussed in our comments on the proposed NESHAPs: NRDC and other environmental organizations, Comments on New Source Performance Standards and National Emission Standards for Hazardous Air Pollutants Reviews, Proposed Rule, November 30, 2011, EPA Docket No. EPA-HQ-OAR-2010-0505, Document ID No. EPA-HQ-OAR-2010-0505-4457. Available at www.regulations.gov.
- 34 Campbell, J.M., Analysis and Management of Petroleum Investments: Risk, Taxes, and Time, John Campbell and Co., 1987.
- 35 The revenue stream is calculated using constant dollars over the payout period because the payout periods are short for the emission control alternatives examined in this report. Discount rates will vary widely for O&G Operators and will add unnecessary complexity to a simplified analysis that seeks to show revenue generated by selling methane will exceed the cost of methane controls. For the purposes of this report, profit computations do not include the opportunity cost of capital. While some companies may assert that they have more profitable places to spend their money than methane emission control, it is not possible for this report to evaluate the opportunity cost of capital because it will vary widely across oil and gas companies, depending on their portfolio of opportunities in the United States and abroad. The purpose of this report is to identify methane control opportunities that are commonly robust economic opportunities, and not to provide a company-specific economic analysis.
- 36 U.S. EPA, Oil and Gas Sector: New Source Performance Standards and National Emission Standards for Hazardous Air Pollutants Reviews, August 23, 2011; Federal Register, v. 76, No. 163 (76 FR 52738), EPA Docket No. EPA-HQ-OAR-2010-0505, FRL-9448-6. Available at <http://www.epa.gov/airquality/oilandgas/index.html>.
- 37 NRDC and other environmental organizations, Comments on New Source Performance Standards and National Emission Standards for Hazardous Air Pollutants Reviews, Proposed Rule, November 30, 2011, EPA Docket No. EPA-HQ-OAR-2010-0505, Document ID No. EPA-HQ-OAR-2010-0505-4240 (NSPS) and Document ID No. EPA-HQ-OAR-2010-0505-4457 (NESHAPs). Available at www.regulations.gov.
- 38 Condensates are low density, high quality API gravity liquid hydrocarbons. The API gravity of condensate is typically 50 degrees to 120 degrees. Depending on the gas composition, hydrocarbons may condense from a gas to a liquid under certain temperature and pressure conditions. Dry gas is routed to the sales line, and liquid condensate is collected in tanks and sold.
- 39 U.S. EPA, Inventory of U.S. Greenhouse Gas Emissions and Sinks (1990-2009), April 15, 2011.
- 40 U.S. EPA, Cost-Effective Methane Emissions Reductions for Small and Midsize Natural Gas Producers, Journal of Petroleum Technology, June 2005.
- 41 U.S. EPA, Regulatory Impact Analysis, Proposed New Source Performance Standards and Amendments to the National Emissions Standards for Hazardous Air Pollutants for the Oil and Natural Gas Industry, July 2011, page 3-21. Available at <http://www.epa.gov/airquality/oilandgas/index.html>.
- 42 U.S. EPA Natural Gas STAR, Proposed Mandatory Reporting of Greenhouse Gases: Petroleum and Natural Gas Systems (Subpart W), Technical Support Document, 2009, page 87, Docket EPA-HQ-OAR-2009-0923.
- 43 U.S. EPA Natural Gas STAR, Reduced Emissions Completions for Hydraulically Fractured Natural Gas Wells, Lessons Learned from Natural Gas STAR Partners, 2011.
- 44 U.S. EPA, Natural Gas STAR Program Accomplishments, 2009. Available at http://www.epa.gov/gasstar/documents/ngstar_accomplishments_2009.pdf. Total sector reductions (2008) = 89.3 Bcf of which 50 percent are the result of RECs (50% of 89.3 Bcf = 45 Bcf).
- 45 Colorado Oil and Gas Conservation Commission, Rule § 805(b) (3).
- 46 Fort Worth Texas, Ordinance No. 18449-02-2009.
- 47 Montana Administrative Rules § 17.8.1711.
- 48 Wyoming Oil and Gas Production Facilities, Chapter 6, Section 2, Permitting Guidance, March 2010.
- 49 American Petroleum Institute (API), Comments to U.S. EPA on Docket ID No. EPA-HQ-OAR-2010-0505, November 30, 2011, Page 94.
- 50 U.S. EPA, Standards of Performance for New Stationary Sources: Oil and Natural Gas Production and Natural Gas Transmission and Distribution; National Emission Standards for Hazardous Air Pollutants From Oil and Natural Gas Production Facilities; and National Emission Standards for Hazardous Air Pollutants From Natural Gas Transmission and Storage Facilities, 2011, page 123 of 604; Docket ID No. EPA-HQ-OAR-2010-0505.
- 51 U.S. EPA, Standards of Performance for New Stationary Sources: Oil and Natural Gas Production and Natural Gas Transmission and Distribution; National Emission Standards for Hazardous Air Pollutants From Oil and Natural Gas Production Facilities; and National Emission Standards for Hazardous Air Pollutants From Natural Gas Transmission and Storage Facilities, 2011, page 125 of 604; Docket ID No. EPA-HQ-OAR-2010-0505.
- 52 U.S. EPA Natural Gas STAR, Reduced Emissions Completions for Hydraulically Fractured Natural Gas Wells, Lessons Learned from Natural Gas STAR Partners, 2011.
- 53 U.S. EPA Natural Gas STAR, Cost-Effective Methane Emission Reductions for Small and Mid-Size Natural Gas Producers, Corpus Christi, Texas, November 1, 2005.
- 54 U.S. EPA Natural Gas STAR, Green Completions, PRO Fact Sheet No. 703, September 2004.
- 55 ICF Incorporated, Technical Assistance for the Draft Supplemental Generic EIS: Oil, Gas and Solution Mining Regulatory Program, prepared for New York State, August 5, 2009.
- 56 U.S. EPA, ExxonMobil Production Company, and American Petroleum Institute, Green Completions, Lessons Learned from Natural Gas STAR, Producers Technology Transfer Workshop, September 21, 2004.
- 57 O’Connell, S., Devon Energy, EPA Natural Gas STAR Program Presentation, March 2007.

- 58 U.S. EPA and Devon Energy, Reduced Emissions Completions (Green Completions), Natural Gas STAR Producers Technology Transfer Workshop, Casper, Wyoming, August 30, 2005. Profit was based on gas at \$1.99 Mcf and condensate at \$22/bbl. Gas and condensate prices are substantially higher in 2010; thus, this is a very conservative profit estimate.
- 59 Smith, G.R., BP America Production Company, Natural Gas Industry Green House Gas Control & Business Opportunity Presentation, 2007.
- 60 The Williams Companies, Reducing Methane Emissions During Completion Operations – Economics Volume Recovered, Williams Production RMT Piceance Basin Operations, Natural Gas Star Producers Technology Transfer Workshop, September 11, 2007.
- 61 U.S. EPA and ICF International, Methane's Role in Promoting Sustainable Development in the Oil and Natural Gas Industry, 2009.
- 62 U.S. EPA Natural Gas STAR, Reduced Emission Completions/ Plunger Lift and Smart Automation, Methane to Markets, Oil & Gas Subcommittee Technology Transfer Workshop, Monterrey, Mexico, January, 2009. Anadarko based the gas value at \$5/Mcf.
- 63 BP, Case Study: North America Gas Strategic Performance Unit's Green Completion's Well Flaring Reductions Program, downloaded April 2010. Available at www.bp.com.
- 64 U.S. EPA, Cost-Effective Methane Emissions Reductions for Small and Midsize Natural Gas Producers, Journal of Petroleum Technology, June 2005.
- 65 Colorado Oil and Gas Conservation Commission, Rule § 805(b) (3) (A) and (C).
- 66 Bondurant, A.V., Dotson, B.D., Oyewole, P.O., BP America, Getting the Last Gasp: Deliquification of Challenging Gas Wells, International Petroleum Technology Conference (IPTC), Paper No. 11651, December 2007.
- 67 Schmitz, R., and Steele, G., VaporTech Energy Services, Inc., Combining Plunger Lift and Compression to Lift Liquids in Low Rate Gas Wells, Canadian International Petroleum Conference, Calgary Alberta, SPE Paper No. 200-159, June 2006.
- 68 U.S. EPA Natural Gas STAR, Reduced Emission Completions/ Plunger Lift and Smart Automation, Methane to Markets, Oil & Gas Subcommittee Technology Transfer Workshop, Monterrey, Mexico, January 2009.
- 69 Bondurant, A.V., Dotson, B.D., Oyewole, P.O., BP America, Getting the Last Gasp: Deliquification of Challenging Gas Wells, International Petroleum Technology Conference (IPTC), Paper No. 11651, December 2007.
- 70 U.S. EPA Natural Gas STAR, Installing Plunger Lift Systems in Gas Wells, Lessons Learned from Natural Gas STAR Partners, 2006.
- 71 U.S. EPA, Inventory of U.S. Greenhouse Gas Emissions and Sinks (1990-2009), April 15, 2011.
- 72 U.S. EPA Natural Gas STAR, Installing Plunger Lift Systems in Gas Wells, Lessons Learned from Natural Gas STAR Partners, 2006.
- 73 Ibid.
- 74 Ibid.
- 75 U.S. EPA Natural Gas STAR, Reduced Emission Completions/ Plunger Lift and Smart Automation, Methane to Markets, Oil & Gas Subcommittee Technology Transfer Workshop, Monterrey, Mexico, January 2009.
- 76 Schneider, T.S., and Mackey, V., Conoco, Inc., Plunger Lift Benefits Bottom Line for a Southeast New Mexico Operator, Society of Petroleum Engineers, Paper No. 59705-MS, 2000.
- 77 U.S. EPA Natural Gas STAR, Installing Plunger Lift Systems in Gas Wells, Lessons Learned from Natural Gas STAR Partners, 2006.
- 78 O'Connell, S., Devon Energy, EPA Natural Gas STAR Program Presentation, March 2007.
- 79 Gantner, B., ConocoPhillips, Testimony to New Energy Economy Petition to the New Mexico Environmental Improvement Board, New Mexico Oil and Gas Association, Notice of Intent to Present Technical Testimony in the Matter of the Petition for Hearing to Adopt New Regulations and to Amend Various Sections of 20.2.1, 20.2.2, 20.2.70, and 20.2.72 NMAC Statewide Cap on Greenhouse Gas Emissions, August 2010.
- 80 U.S. EPA Natural Gas STAR, Installing Plunger Lift Systems in Gas Wells, Lessons Learned from Natural Gas STAR Partners, 2006.
- 81 Gas Processors Suppliers Association (GPSA), Gas Processors Suppliers Association Handbook, Tenth Edition 1987, revised 1994.
- 82 U.S. EPA Natural Gas STAR, Reroute Glycol Skimmer Gas, PRO Fact Sheet No. 201, 2004.
- 83 U.S. EPA Natural Gas STAR, Replacing Gas-Assisted Glycol Pumps with Electric Pumps, Lessons Learned from Natural Gas STAR Partners, 2009.
- 84 U.S. EPA, Inventory of U.S. Greenhouse Gas Emissions and Sinks (1990-2009), April 15, 2011.
- 85 U.S. EPA Natural Gas STAR, Replacing Gas-Assisted Glycol Pumps with Electric Pumps, Lessons Learned from Natural Gas STAR Partners, 2009.
- 86 U.S. EPA Natural Gas STAR, Optimize Glycol Circulation and Install Flash Tank Separators in Glycol Dehydrators, Lessons Learned from Natural Gas STAR Partners, 2009.
- 87 U.S. EPA Natural Gas STAR, Natural Gas Dehydration, Natural Gas STAR Producers Technology Transfer Workshop, Durango, Colorado, September 13, 2007.
- 88 The wide range in methane capture opportunity is a function of the dehydrator size, and how efficiently the operator previously optimized the glycol circulation rate.
- 89 U.S. EPA Natural Gas STAR, Cost-Effective Methane Emission Reductions for Small and Mid-Size Natural Gas Producers, Corpus Christi, Texas, November 1, 2005.
- 90 U.S. EPA Natural Gas STAR, Natural Gas Dehydration, Natural Gas STAR Producers Technology Transfer Workshop, Durango, Colorado, September 13, 2007.
- 91 U.S. EPA, Inventory of U.S. Greenhouse Gas Emissions and Sinks (1990-2009), April 15, 2011.
- 92 Under section 112(d) of the Clean Air Act.
- 93 U.S. EPA Natural Gas STAR, Cost-Effective Methane Emission Reductions for Small and Mid-Size Natural Gas Producers, Corpus Christi, Texas, November 1, 2005.
- 94 U.S. EPA Natural Gas STAR, Natural Gas Dehydration, Natural Gas STAR Producers Technology Transfer Workshop, Durango, Colorado, September 13, 2007.
- 95 U.S. EPA Natural Gas STAR, Cost-Effective Methane Emission Reductions for Small and Mid-Size Natural Gas Producers, Corpus Christi, Texas, November 1, 2005.

- 96 U.S. EPA Natural Gas STAR, Optimize Glycol Circulation and Install Flash Tank Separators in Glycol Dehydrators, Lessons Learned from Natural Gas STAR Partners, 2009.
- 97 Hygroscopic means readily absorbs moisture.
- 98 U.S. EPA Natural Gas STAR, Replacing Glycol Dehydrators with Desiccant Dehydrators, Lessons Learned from Natural Gas STAR Partners, 2009.
- 99 U.S. EPA, Inventory of U.S. Greenhouse Gas Emissions and Sinks (1990-2009), April 15, 2011.
- 100 U.S. EPA, Cost-Effective Methane Emissions Reductions for Small and Midsize Natural Gas Producers, Journal of Petroleum Technology, June 2005.
- 101 U.S. EPA Natural Gas STAR, Replacing Glycol Dehydrators with Desiccant Dehydrators, Lessons Learned from Natural Gas STAR Partners, 2006.
- 102 Ibid.
- 103 U.S. EPA Natural Gas STAR, Natural Gas Dehydration, Natural Gas STAR Producers Technology Transfer Workshop, Durango, Colorado, September 13, 2007.
- 104 U.S. EPA Natural Gas STAR, Replacing Glycol Dehydrators with Desiccant Dehydrators, Lessons Learned from Natural Gas STAR Partners, 2009.
- 105 Smith, G.R., BP America Production Company, Natural Gas Industry Green House Gas Control & Business Opportunity Presentation, 2007.
- 106 U.S. EPA Natural Gas STAR, Reducing Methane Emissions from Reciprocating and Centrifugal Compressors, Methane to Markets, Oil & Gas Subcommittee Technology Transfer Workshop, 2009.
- 107 U.S. EPA, Inventory of U.S. Greenhouse Gas Emissions and Sinks (1990-2009), April 15, 2011.
- 108 U.S. EPA Natural Gas STAR, Replacing Wet Seals with Dry Seals in Centrifugal Compressors, 2009; EPA 430-B-03-012.
- 109 Ibid.
- 110 Ibid.
- 111 U.S. EPA, Replacing Wet Seals with Dry Seals in Centrifugal Compressors, Lessons Learned from Natural Gas STAR Partners, 2006.
- 112 U.S. EPA Natural Gas STAR, Compressor Best Practices, Methane to Markets, 2006.
- 113 PEMEX is Mexico's national petroleum company.
- 114 U.S. EPA Natural Gas STAR, Reducing Emissions, Increasing Efficiency, Maximizing Profits, Methane to Markets, Natural Gas STAR International, 2008. Available at www.epa.gov/gasstar/international/index.html.
- 115 Targa Resources and the Gas Processors Association, Methane Savings from Compressors and VRUs, Innovative Technologies for the Oil & Gas Industry: Product Capture, Process Optimization, and Pollution Prevention, July 27, 2006.
- 116 U.S. EPA Natural Gas STAR, Reducing Emissions, Increasing Efficiency, Maximizing Profits, Methane to Markets, Natural Gas STAR International, 2008. Available at www.epa.gov/gasstar/international/index.html.
- 117 Ibid.
- 118 Gas Research Institute Canada, Handbook for Estimating Methane Emissions from Canadian Natural Gas Systems, 1998.
- 119 U.S. EPA Natural Gas STAR, Reduced Methane Emissions from Compressor Rod Packing Systems, Lessons Learned from Natural Gas STAR Partners, October 2006.
- 120 U.S. EPA, Inventory of U.S. Greenhouse Gas Emissions and Sinks (1990-2009), April 15, 2011.
- 121 Lev-On, M., Best Management Practices for Methane Emission Reductions, Natural Gas Star International, March 2010.
- 122 U.S. EPA Natural Gas STAR, Reducing Emissions, Increasing Efficiency, Maximizing Profits, Methane to Markets, Natural Gas STAR International, 2008. Available at www.epa.gov/gasstar/international/index.html.
- 123 U.S. EPA Natural Gas STAR, Reduced Methane Emissions from Compressor Rod Packing Systems, Lessons Learned from Natural Gas STAR Partners, October 2006.
- 124 U.S. EPA, Cost-Effective Methane Emissions Reductions for Small and Midsize Natural Gas Producers, Journal of Petroleum Technology, June 2005.
- 125 Colorado Oil and Gas Conservation Commission Rule 805(b)(2) (E).
- 126 Wyoming Oil and Gas Production Facilities, Chapter 6, Section 2 Permitting Guidance, March 2010; "WY Revised March 2010 Guidance."
- 127 U.S. EPA Natural Gas STAR, Options for Reducing Methane Emissions from Pneumatic Devices in the Natural Gas Industry, Lessons Learned from Natural Gas STAR Partners, October 2006.
- 128 U.S. EPA, Inventory of U.S. Greenhouse Gas Emissions and Sinks (1990-2009), April 15, 2011.
- 129 U.S. EPA and Occidental Oil & Gas Corporation, Methane Recovery from Pneumatic Devices, Vapor Recovery Units and Dehydrators, Methane to Markets, October 6, 2005.
- 130 U.S. EPA Natural Gas STAR, Cost-Effective Methane Emission Reductions for Small and Mid-Size Natural Gas Producers, Corpus Christi, Texas, November 1, 2005.
- 131 U.S. EPA Natural Gas STAR, Options for Reducing Methane Emissions from Pneumatic Devices in the Natural Gas Industry, Lessons Learned from Natural Gas STAR Partners, October 2006.
- 132 U.S. EPA Natural Gas STAR, Cost-Effective Methane Emission Reductions for Small and Mid-Size Natural Gas Producers, Corpus Christi, Texas, November 1, 2005.
- 133 U.S. EPA and Occidental Oil & Gas Corporation, Methane Recovery from Pneumatic Devices, Vapor Recovery Units and Dehydrators, Methane to Markets, October 6, 2005.
- 134 U.S. EPA Natural Gas STAR, Options for Reducing Methane Emissions from Pneumatic Devices in the Natural Gas Industry, Lessons Learned from Natural Gas STAR Partners, October 2006.
- 135 U.S. EPA, Cost-Effective Methane Emissions Reductions for Small and Midsize Natural Gas Producers, Journal of Petroleum Technology, June 2005.
- 136 U.S. EPA Natural Gas STAR, Cost-Effective Methane Emission Reductions for Small and Mid-Size Natural Gas Producers, Corpus Christi, Texas, November 1, 2005.
- 137 U.S. EPA Natural Gas STAR, Convert Gas Pneumatic Controls to Instrument Air, Lessons Learned from Natural Gas STAR Partners, 2006.
- 138 Smith, G.R., BP America Production Company, Natural Gas Industry Green House Gas Control & Business Opportunity Presentation, 2007.

- 139 Star-Tribune Energy Reporter, October 11, 2010.
- 140 U.S. EPA and Occidental Oil & Gas Corporation, Methane Recovery from Pneumatic Devices, Vapor Recovery Units and Dehydrators, Methane to Markets, October 6, 2005.
- 141 American Petroleum Institute, Procedures for Welding or Hot Tapping on Equipment in Service, API Recommended Practice 2201, Third Edition and Fourth Edition, October 1985 and September 1995.
- 142 U.S. EPA Natural Gas STAR, Using Pipeline Pump-down Techniques to Lower Gas Line Pressure Before Maintenance, Lessons Learned from Natural Gas STAR Partners, 2009.
- 143 U.S. EPA, Inventory of U.S. Greenhouse Gas Emissions and Sinks (1990-2009), April 15, 2011.
- 144 PEMEX and U.S. EPA Natural Gas STAR, Pipeline Maintenance and Repair, Methane to Markets, Technology Transfer Workshop, Villahermosa, Mexico, April, 2006.
- 145 U.S. EPA Natural Gas STAR, Using Hot Taps for in Service Pipeline Connections, Lessons Learned from Natural Gas STAR Partners, 2009.
- 146 U.S. EPA Natural Gas STAR, Inject Blowdown Gas into Low Pressure Mains, PRO Fact Sheet No. 401, 2004.
- 147 U.S. EPA Natural Gas STAR, Using Pipeline Pump-down Techniques to Lower Gas Line Pressure Before Maintenance, Lessons Learned from Natural Gas STAR Partners, 2009.
- 148 U.S. EPA, Cost-Effective Methane Emissions Reductions for Small and Midsize Natural Gas Producers, Journal of Petroleum Technology, June 2005.
- 149 Goodyear, M.A. (Comm Engineering), Graham, A.L. (TotalFinaElf E&P, Inc.) et al., Vapor Recovery of Natural Gas Using Non-Mechanical Technology, Society of Petroleum Engineers, Paper No. 800599, 2003.
- 150 U.S. EPA, Inventory of U.S. Greenhouse Gas Emissions and Sinks (1990-2009), April 15, 2011.
- 151 The U.S. EPA's proposed NSPS requirements would apply to vessels with a throughput equal to or greater than 1 barrel of condensate per day or 20 barrels of crude oil per day, which are equivalent to VOC emissions of about 6 tons per year.
- 152 U.S. EPA Natural Gas STAR Partners, Reducing Methane Emissions with Vapor Recovery on Storage Tanks, Methane to Markets, Oil & Gas Subcommittee Technology Transfer Workshop, January 28, 2009.
- 153 U.S. EPA Natural Gas STAR, Reducing Methane Emissions with Vapor Recovery on Storage Tanks, Lessons learned from the Natural Gas STAR Partners, March 23, 2010, Newfield Exploration Company, Anadarko Petroleum Corporation, Utah Petroleum Association, Interstate O&G Compact Commission, Independent Petroleum Association of Mountain States.
- 154 Ibid.
- 155 Ibid.
- 156 Richards, L.S., Hy-Bon Engineering, Co., Fundamentals of Vapor Recovery, Associated Gas is Lost Product and Lost Revenue, October 2005.
- 157 Boyer, B.E. (COMM Engineering), and O'Connell, S.C. (Devon Energy Corp.), Optimize Separator Operating Pressures to Reduce Flash Losses, Society of Petroleum Engineers (SPE) Paper No. 94373-MS, 2005.
- 158 Avoiding oxygen entrainment in any gas piping and distribution system is a typical engineering design requirement, and is not unique to vapor recovery units design.
- 159 U.S. EPA, Methane's Role in Promoting Sustainable Development in the Oil and Natural Gas Industry, 2009.
- 160 Squarek, J. (Canadian Association of Petroleum Producers), Layer, M. (Environment Canada) and Picard, D. (Clearstone Engineering Ltd.), Development of a Best Management Practice in Canada for Controlling Fugitive Emissions at Upstream Oil and Gas Facilities, 2005.
- 161 Heath, M.W., Leak Detection and Quantification of Fugitive Methane Emissions at Natural Gas Facilities, 2009.
- 162 TransCanada, Methane Savings from Natural Gas Compressors, Energy Management Workshop, January 16, 2007.
- 163 Picard, D. (Clearstone Engineering Ltd.), Cost Effective Opportunities to Reduce Methane Emissions and Losses, 2005.
- 164 U.S. EPA Natural Gas Star, Reducing Methane Emissions through Directed Inspection and Maintenance (DI&M), Methane to Markets, Oil & Gas Subcommittee Technology Transfer Workshop, 2009.
- 165 U.S. EPA, Inventory of U.S. Greenhouse Gas Emissions and Sinks (1990-2009), April 15, 2011.
- 166 Code of Federal Regulations, Title 40: Protection of Environment (40 CFR) 60, Standards of Performance for New Stationary Sources, subpart VVa.
- 167 U.S. EPA, Oil and Gas Sector: New Source Performance Standards and National Emission Standards for Hazardous Air Pollutants Reviews, August 23, 2011, Federal Register, v. 76, No. 163 (76 FR 52738), EPA Docket No. EPA-HQ-OAR-2010-0505, FRL-9448-6. Available at <http://www.epa.gov/airquality/oilandgas/index.html>.
- 168 U.S. EPA Natural Gas Star, Reducing Methane Emissions through Directed Inspection and Maintenance (DI&M), Methane to Markets, Oil & Gas Subcommittee Technology Transfer Workshop, 2009.
- 169 U.S. EPA Natural Gas STAR, Directed Inspection and Maintenance at Gas Processing Plants and Booster Stations, Lessons Learned from Natural Gas STAR Partners, 2003.
- 170 U.S. EPA Natural Gas STAR, Directed Inspection and Maintenance at Compressor Stations, Lessons Learned from Natural Gas STAR Partners, 2003.
- 171 U.S. EPA Natural Gas STAR, Reducing Methane Emissions Through Directed Inspection and Maintenance (DI&M), Methane to Markets, Oil & Gas Subcommittee Technology Transfer Workshop, 2009.
- 172 NRDC and other environmental organizations, Comments on New Source Performance Standards and National Emission Standards for Hazardous Air Pollutants Reviews, Proposed Rule, November 30, 2011, EPA Docket No. EPA-HQ-OAR-2010-0505, Document ID No. EPA-HQ-OAR-2010-0505-4240. Available at www.regulations.gov.
- 173 U.S. EPA Natural Gas STAR, Reduced Emissions Completions for Hydraulically Fractured Natural Gas Wells, Lessons Learned from Natural Gas STAR Partners, 2011.
- 174 U.S. EPA Natural Gas STAR, Cost-Effective Methane Emission Reductions for Small and Mid-Size Natural Gas Producers, Corpus Christi, Texas, November 1, 2005.
- 175 U.S. EPA, ExxonMobil Production Company, and American Petroleum Institute, Green Completions, Lessons Learned from Natural Gas STAR, Producers Technology Transfer Workshop, September 21, 2004.

- 176 O'Connell, S., Devon Energy, EPA Natural Gas STAR Program Presentation, March 2007.
- 177 U.S. EPA and Devon Energy, Reduced Emissions Completions (Green Completions), Natural Gas STAR Producers Technology Transfer Workshop, Casper, Wyoming, August 30, 2005.
- 178 Ibid.
- 179 Smith, G.R., BP America Production Company, Natural Gas Industry Green House Gas Control & Business Opportunity Presentation, 2007.
- 180 The Williams Companies, Reducing Methane Emissions During Completion Operations – Economics Volume Recovered, Williams Production RMT Piceance Basin Operations, Natural Gas Star Producers Technology Transfer Workshop, September 11, 2007.
- 181 U.S. EPA and ICF International, Methane's Role in Promoting Sustainable Development in the Oil and Natural Gas Industry, 2009.
- 182 U.S. EPA Natural Gas STAR Partners, Reduced Emission Completions/Plunger Lift and Smart Automation, Methane to Markets, Oil & Gas Subcommittee Technology Transfer Workshop, Monterrey, Mexico, January, 2009.
- 183 ICF Incorporated, Technical Assistance for the Draft Supplemental Generic EIS: Oil, Gas and Solution Mining Regulatory Program, prepared for New York State, August 5, 2009.
- 184 U.S. EPA, Oil and Natural Gas Sector: Standards of Performance for Crude Oil and Natural Gas Production, Transmission and Distribution, Background Technical Support for Proposed Standards (NSPS TSD), 2011, pages 4-15 to 4-18. Available at <http://www.epa.gov/airquality/oilandgas/index.html>.
- 185 U.S. EPA Natural Gas STAR, Installing Plunger Lift Systems in Gas Wells, Lessons Learned from Natural Gas STAR Partners, 2006.
- 186 Ibid.
- 187 U.S. EPA Natural Gas Star, Reduced Emission Completions/Plunger Lift and Smart Automation, Methane to Markets, Oil & Gas Subcommittee Technology Transfer Workshop, Monterrey, Mexico, January 2009.
- 188 U.S. EPA Natural Gas STAR, Installing Plunger Lift Systems in Gas Wells, Lessons Learned from Natural Gas STAR Partners, 2006.
- 189 U.S. EPA Natural Gas STAR, Optimize Glycol Circulation and Install Flash Tank Separators in Glycol Dehydrators, Lessons Learned from Natural Gas STAR Partners, 2009.
- 190 U.S. EPA Natural Gas STAR, Natural Gas Dehydration, Natural Gas STAR Producers Technology Transfer Workshop, Durango, Colorado, September 13, 2007.
- 191 EPA Natural Gas STAR, Cost-Effective Methane Emission Reductions for Small and Mid-Size Natural Gas Producers, Corpus Christi, Texas, November 1, 2005.
- 192 U.S. EPA Natural Gas STAR, Natural Gas Dehydration, Natural Gas STAR Producers Technology Transfer Workshop, Durango, Colorado, September 13, 2007.
- 193 U.S. EPA, Inventory of U.S. Greenhouse Gas Emissions and Sinks (1990-2009), April 15, 2011.
- 194 U.S. EPA Natural Gas STAR, Replacing Glycol Dehydrators with Desiccant Dehydrators, Lessons Learned from Natural Gas STAR Partners, 2009.
- 195 Smith, G.R., BP America Production Company, Natural Gas Industry Green House Gas Control & Business Opportunity Presentation, 2007.
- 196 U.S. EPA Natural Gas STAR, Replacing Wet Seals with Dry Seals in Centrifugal Compressors, Lessons Learned from Natural Gas STAR Partners, 2006.
- 197 U.S. EPA Natural Gas STAR, Replacing Wet Seals with Dry Seals in Centrifugal Compressors, 2009, EPA 430-B-03-012.
- 198 U.S. EPA, Inventory of U.S. Greenhouse Gas Emissions and Sinks (1990-2009), April 15, 2011.
- 199 U.S. EPA, Methane to Markets, Reducing Emissions, Increasing Efficiency, Maximizing Profits, 2008. Available at www.epa.gov/gasstar/international/index.html.
- 200 Targa Resources and the Gas Processors Association, Methane Savings from Compressors and VRUs, Innovative Technologies for the Oil & Gas Industry: Product Capture, Process Optimization, and Pollution Prevention, July 27, 2006.
- 201 U.S. EPA, Oil and Natural Gas Sector: Standards of Performance for Crude Oil and Natural Gas Production, Transmission and Distribution, Background Technical Support for Proposed Standards (NSPS TSD), 2011, pages 6-19 to 6-22. Available at <http://www.epa.gov/airquality/oilandgas/index.html>.
- 202 U.S. EPA Natural Gas STAR, Reduced Methane Emissions from Compressor Rod Packing Systems, Lessons Learned from Natural Gas STAR Partners, October 2006.
- 203 U.S. EPA, Cost-Effective Methane Emissions Reductions for Small and Midsize Natural Gas Producers, Journal of Petroleum Technology, June 2005.
- 204 U.S. EPA, Oil and Natural Gas Sector: Standards of Performance for Crude Oil and Natural Gas Production, Transmission and Distribution, Background Technical Support for Proposed Standards (NSPS TSD), 2011, pages 6-15 – 6-18. Available at <http://www.epa.gov/airquality/oilandgas/index.html>.
- 205 U.S. EPA and Occidental Oil & Gas Corporation, Methane Recovery from Pneumatic Devices, Vapor Recovery Units and Dehydrators, Methane to Markets, October 6, 2005.
- 206 U.S. EPA Natural Gas STAR, Cost-Effective Methane Emission Reductions for Small and Mid-Size Natural Gas Producers, Corpus Christi, Texas, November 1, 2005.
- 207 U.S. EPA, Cost-Effective Methane Emissions Reductions for Small and Midsize Natural Gas Producers, Journal of Petroleum Technology, June 2005.
- 208 U.S. EPA Natural Gas STAR, Options for Reducing Methane Emissions from Pneumatic Devices in the Natural Gas Industry, Lessons Learned from Natural Gas STAR Partners, October 2006.
- 209 Smith, G.R., BP America Production Company, Natural Gas Industry Green House Gas Control & Business Opportunity Presentation, 2007.
- 210 U.S. EPA, Oil and Natural Gas Sector: Standards of Performance for Crude Oil and Natural Gas Production, Transmission and Distribution, Background Technical Support for Proposed Standards (NSPS TSD), 2011, pages 5-14 to 5-17. Available at <http://www.epa.gov/airquality/oilandgas/index.html>.
- 211 U.S. EPA Natural Gas STAR, Cost-Effective Methane Emission Reductions for Small and Mid-Size Natural Gas Producers, Corpus Christi, Texas, November 1, 2005.
- 212 U.S. EPA, Cost-Effective Methane Emissions Reductions for Small and Midsize Natural Gas Producers, Journal of Petroleum Technology, June 2005.

- 213 U.S. EPA Natural Gas STAR, Convert Gas Pneumatic Controls to Instrument Air, Lessons Learned from Natural Gas STAR Partners, 2006.
- 214 U.S. EPA, Oil and Natural Gas Sector: Standards of Performance for Crude Oil and Natural Gas Production, Transmission and Distribution, Background Technical Support for Proposed Standards (NSPS TSD), 2011, pages 5-19 to 5-22. Available at <http://www.epa.gov/airquality/oilandgas/index.html>.
- 215 U.S. EPA Natural Gas STAR, Reducing Methane Emissions with Vapor Recovery on Storage Tanks, Lessons learned from the Natural Gas STAR Partners, March 23, 2010, Newfield Exploration Company, Anadarko Petroleum Corporation, Utah Petroleum Association, Interstate O&G Compact Commission, Independent Petroleum Association of Mountain States.
- 216 Ibid.
- 217 Ibid.
- 218 Richards, L.S., Hy-Bon Engineering, Co., Fundamentals of Vapor Recovery, Associated Gas is Lost Product and Lost Revenue, October 2005.
- 219 U.S. EPA, Oil and Natural Gas Sector: Standards of Performance for Crude Oil and Natural Gas Production, Transmission and Distribution, Background Technical Support for Proposed Standards (NSPS TSD), 2011, pages 7-13 to 7-14. Available at <http://www.epa.gov/airquality/oilandgas/index.html>.
- 220 U.S. EPA Natural Gas STAR, Directed Inspection and Maintenance at Gas Processing Plants and Booster Stations, Lessons Learned from Natural Gas STAR Partners, 2003.
- 221 U.S. EPA Natural Gas STAR, Directed Inspection and Maintenance at Compressor Stations, Lessons Learned from Natural Gas STAR Partners, 2003.
- 222 U.S. EPA Natural Gas Star, Reducing Methane Emissions through Directed Inspection and Maintenance (DI&M), Methane to Markets, Oil & Gas Subcommittee Technology Transfer Workshop, 2009.
- 223 TransCanada, Methane Savings from Natural Gas Compressors, Energy Management Workshop, January 16, 2007.
- 224 U.S. EPA, Oil and Natural Gas Sector: Standards of Performance for Crude Oil and Natural Gas Production, Transmission and Distribution, Background Technical Support for Proposed Standards (NSPS TSD), 2011, pages 8-23 to 8-30, mainly Tables 8-14 to 8-17. Available at <http://www.epa.gov/airquality/oilandgas/index.html>.



Natural Resources Defense Council

40 West 20th Street
New York, NY 10011
212 727-2700
Fax 212 727-1773

Beijing

Chicago

Los Angeles

Montana

San Francisco

Washington

www.nrdc.org