

**Public Interest Energy Research (PIER) Program
FINAL PROJECT REPORT**

**2020 STRATEGIC ANALYSIS OF
ENERGY STORAGE IN CALIFORNIA**



Prepared for: California Energy Commission

Prepared by: University of California, Berkeley School of Law
University of California, Los Angeles
University of California, San Diego

NOVEMBER 2011

CEC-500-2011-047

Prepared by:

University of California, Berkeley School of Law

Jessica Intrator
Ethan Elkind, Principal Investigator (joint
appointment at UCLA School of Law)
Steven Weissman
Morgan Sawchuk
Emily Bartlett



University of California, Los Angeles

Andris R. Abele, Principal Investigator
Bruce S. Dunn, Ph.D.
Tsu-Chin Tsao, Ph.D.
Rita Blaik
Christopher Lim
David Luong
Leland Smith

University of California, San Diego

Byron Washom, Principal Investigator

Contract Number: 500-02-004

Work Authorization: MRA-02-088

Prepared for:

California Energy Commission

Cathy Turner
Contract Manager

Avtar Bining, Ph.D.
Project Manager

Mike Gravely
Office Manager
Energy Systems Research Office

Laurie ten Hope
Deputy Director
ENERGY RESEARCH AND DEVELOPMENT DIVISION

Robert P. Oglesby
Executive Director

DISCLAIMER

This report was prepared as the result of work sponsored by the California Energy Commission. It does not necessarily represent the views of the Energy Commission, its employees or the State of California. The Energy Commission, the State of California, its employees, contractors and subcontractors make no warrant, express or implied, and assume no legal liability for the information in this report; nor does any party represent that the uses of this information will not infringe upon privately owned rights. This report has not been approved or disapproved by the California Energy Commission nor has the California Energy Commission passed upon the accuracy or adequacy of the information in this report.

ACKNOWLEDGMENTS

The project titled *2020 Strategic Analysis of Energy Storage in California* is funded by the California Energy Commission's Public Interest Energy Research (PIER) Program, through the California Institute for Energy and Environment.

The authors would like to thank Dr. Carl Blumstein, Dr. Merwin Brown, and Mr. Larry Miller with the California Institute for Energy and Environment for their help with this project, as well as Jan Kleissl, Ph.D. of the University of California, San Diego. Project support provided by Kristen Bargmeyer at the University of California, Berkeley School of Law is gratefully acknowledged. In addition, the authors thank Avtar Bining and Mike Gravely from the California Energy Commission for their dedication to the project and input on the drafts.

This report benefitted greatly from its Project Advisory Committee, which offered crucial guidance and input during an in-person meeting and through electronic feedback on multiple drafts. The authors are grateful for the committee members' dedicated support and insightful comments. Any errors and all policy conclusions contained in this document are strictly those of the authors. The Project Advisory Committee for the "2020 Strategic Analysis of Energy Storage in California" consists of the following academic, nonprofit, public sector, and industry experts:

- Victor Babbit, RES Americas
- Matt Barmack, Calpine Corporation
- Deborah Behles, Environmental Law and Justice Clinic, Golden Gate University School of Law
- Nicole A. Blake, Consumer Federation of California
- Ed Cazalet, MegaWatt Storage Farms, Inc.
- Larry Chaset, Sustainable Energy Futures
- Stephen R. Clarke, Applied Intellectual Capital
- Carlos Coe, Xtreme Power Solutions, Inc.
- Michael Colvin, California Public Utilities Commission
- Eric Cutter, Energy and Environmental Economics, Inc.
- Paul Denholm, National Renewable Energy Laboratory
- Jim Detmers, Power Systems Resources, Inc.
- Marcelo E. Di Paolo, Los Angeles Department of Water and Power
- J. Douglas Divine, Eagle Crest Energy Company
- Steve Eckert, Brookfield Renewable Power Inc.
- Jack Ellis, Resero Consulting, Inc.
- Jim Eyer, Distributed Utility Association
- Adam Green, Solar Reserve
- Cris Grieco, Gravity Power, LLC

- Ross Guttromson, Sandia National Laboratories
- Dave Hawkins, KEMA, Inc.
- Joe Heinzmann, Altairnano
- Eric Hsieh, A123 Systems, Inc.
- Judith Judson, Beacon Power Corporation
- David Kates, Elsinore Valley Municipal Water District (EVWMD)
- Praveen Kathpal, AES Energy Storage, LLC
- Chris King, eMeter Strategic Consulting
- Samantha King, International Quality and Productivity Center (IQPC)
- Monica Lamb, First Solar, Inc.
- Janice Lin, California Energy Storage Alliance
- Chris Marnay, Lawrence Berkeley National Laboratory
- Jim McIntosh, California Independent System Operator
- Alex Morris, Southern California Edison
- David Nemtzow, Ice Energy, Inc.
- Robert Pratt, Pacific Northwest National Laboratory
- Dan Rastler, Electric Power Research Institute
- Adam Rauwerdink, SustainX, Inc.
- Mark Rawson, Sacramento Municipal Utilities District
- Stacey Reineccius, Power and Energy Consulting
- Johannes Rittershausen, Southern California Edison
- Gwen Rose, Vote Solar
- Heather Sanders, California Independent System Operator
- Klaus Schüss, KS Engineers
- Chris Shelton, AES Energy Storage, LLC
- Kevin Snyder, HDR/DTA Inc.
- John Eric Thalman, Pacific Gas and Electric Company
- Sarah Thomas, California Public Utilities Commission, Division of Ratepayer Advocates
- William Torre, San Diego Gas & Electric Company
- Rick Winter, Primus Power Corporation

PREFACE

The California Energy Commission Public Interest Energy Research (PIER) Program supports public interest energy research and development that will help improve the quality of life in California by bringing environmentally safe, affordable, and reliable energy services and products to the marketplace.

The PIER Program conducts public interest research, development, and demonstration (RD&D) projects to benefit California.

The PIER Program strives to conduct the most promising public interest energy research by partnering with RD&D entities, including individuals, businesses, utilities, and public or private research institutions.

PIER funding efforts are focused on the following RD&D program areas:

- Buildings End-Use Energy Efficiency
- Energy Innovations Small Grants
- Energy-Related Environmental Research
- Energy Systems Integration
- Environmentally Preferred Advanced Generation
- Industrial/Agricultural/Water End-Use Energy Efficiency
- Renewable Energy Technologies
- Transportation

The report *2020 Strategic Analysis of Energy Storage in California* (Contract Number 500-02-004, Work Authorization Number MRA-02-088), conducted by the University of California, Berkeley School of Law; University of California, Los Angeles; and University of California, San Diego, contributes to PIER's Energy Systems Integration program area.

When the source of a table, figure or photo is not otherwise credited, it is the work of the author of the report.

For more information about the PIER Program, please visit the Energy Commission's website at www.energy.ca.gov/research/ or contact the Energy Commission at 916-327-1551.

ABSTRACT

As California progresses towards its goal of 33 percent renewable electricity generation, the potential for energy storage to help integrate renewable resources and maintain a reliable and efficient electric grid takes on great significance. In 2010, the California Legislature enacted Assembly Bill 2514 (Skinner, Chapter 469, Statutes 2010), directing the California Public Utilities Commission (CPUC) to convene a proceeding to define energy storage procurement targets, if any, for investor-owned utilities. Under the statute, similar targets, on a slightly larger scale, would also be required for publicly owned utilities. This report presents a strategic analysis of energy storage for California by 2020. The report assesses current energy storage technologies, discusses the diverse policies affecting deployment in California, and outlines critical technology gaps, future research needs, and policy reforms. It also provides a reference framework for the Energy Commission, CPUC, and other regulatory agencies to use as they develop solutions for how commercially ready energy storage technologies can be cost-effectively applied in California to reduce costs to ratepayers, reduce emissions from fossil fuel generation, and enable and accelerate the implementation of more renewable generation and its integration in California's electricity system. The report also provides a roadmap for the California Energy Commission to use when allocating public interest energy research funds for developing, improving and demonstrating energy storage technologies.

Keywords: energy storage, renewable energy, renewable portfolio standards, AB 2514, variable renewable energy integration, distributed generation, distributed energy resources, smart grid, peak load shaving, permanent load shifting, ancillary services, frequency regulation

Please use the following citation for this report:

Andris Abele, Ethan Elkind, Jessica Intrator, Byron Washom, et al (University of California, Berkeley School of Law; University of California, Los Angeles; and University of California, San Diego) 2011, *2020 Strategic Analysis of Energy Storage in California*, California Energy Commission. Publication Number: CEC-500-2011-047.

TABLE OF CONTENTS

ACKNOWLEDGMENTS	i
PREFACE.....	iii
ABSTRACT.....	iv
TABLE OF CONTENTS	v
LIST OF FIGURES.....	ix
LIST OF TABLES.....	x
EXECUTIVE SUMMARY	1
Summary of Energy Storage Technologies	1
2020 Energy Storage Vision and Policy Priorities	6
CHAPTER 1: Introduction: The Importance of Energy Storage and Technology Status	13
1.1 Electrochemical Energy Storage.....	16
1.1.1 Lead-Acid Batteries.....	17
1.1.2 Nickel-Based Batteries.....	18
1.1.3 Lithium Ion Batteries	19
1.1.4 Flow Batteries	22
1.1.5 Sodium-Beta Alumina Batteries.....	25
1.1.6 Metal Air Batteries	28
1.1.7 Electric Double Layer Capacitors	30
1.1.8 Pseudocapacitors	32
1.1.9 Hybrid Capacitors.....	33
1.2 Mechanical Energy Storage	34
1.2.1 Pumped Hydro.....	34
1.2.2 Compressed Air Energy Storage	40
1.2.3 Flywheels	48
1.3 Thermal Energy Storage.....	56
1.3.1 Solar Thermal	56
1.3.2 Thermal Storage for Heating, Ventilation, and Air Conditioning (HVAC)	58
1.4 Hydrogen as an Energy Storage System.....	61

1.4.1	Description of Technology.....	61
1.4.2	Technology Status.....	64
1.4.3	Technology Limitations	66
1.4.4	R&D Needs and Opportunities.....	66
1.5	General Cost Data for Energy Storage Technologies	67
CHAPTER 2: Regulatory and Policy Framework.....		70
2.1	Energy Storage Policy and Regulatory Landscape	70
2.1.1	California’s Clean Energy Policy Push	70
2.1.2	Legislative Mandates: AB 2514, AB 32, and California’s RPS	74
2.1.3	Institutional and Regulatory Action: Regulatory Proceedings and Rate Cases....	77
2.1.4	Comparative Cases: Energy Storage Policy Out of State and Abroad	97
CHAPTER 3: Technology Gaps, Research and Development Needs, and Policy Challenges... 104		
3.1	Technology Status Findings: Gaps and R&D Priorities.....	104
3.2	Policy and Regulatory Findings: Barriers and Challenges.....	105
3.2.1	Valuation and Cost Recovery	105
3.2.2	Awareness and Collaboration.....	111
3.2.3	Competing Policy Priorities.....	112
CHAPTER 4: Applications and Scenarios Analyses for Energy Storage in California – Background, Purpose, and Approach.....		114
4.1	California’s Grid Needs and Applications Selection	115
4.2	Possible Drivers for Energy Storage Deployment in California.....	117
4.2.1	Procurement Targets	117
4.2.2	Tariff and Market Reform.....	118
4.2.3	Loading Order and Resource Adequacy Requirements.....	119
4.2.4	Financial Incentives	120
4.2.5	Targeted Research and Development Funding.....	123
CHAPTER 5: Applications and Scenarios Analyses for Energy Storage in California		132
5.1	Exemplary Application #1: Area and Frequency Regulation	132
5.1.1	Area and Frequency Regulation: Definition and Application.....	133

5.1.2	Area and Frequency Regulation: Technology Status and Market Fit.....	134
5.1.3	Area and Frequency Regulation: Technology Potential.....	137
5.1.4	Area and Frequency Regulation: Regulatory Status and Policy Changes	138
5.1.5	Area and Frequency Regulation: Benefits and Costs.....	140
5.1.6	Area and Frequency Regulation: Recommended Next Steps and Milestones....	145
5.2	Exemplary Application #2: Renewables Grid Integration.....	146
5.2.1	Renewables Grid Integration: Definition and Application.....	148
5.2.2	Renewables Grid Integration: Technology Status and Fit.....	150
5.2.3	Renewables Grid Integration: Technology Potential	153
5.2.4	Renewables Grid Integration: Regulatory Status and Policy Changes	156
5.2.5	Renewables Grid Integration: Benefits and Costs	160
5.2.6	Milestones and Next Steps for Energy Storage for Renewables Grid Integration	165
5.3	Exemplary Application #3: Community Energy Storage / Distributed Energy Storage Systems (DESS)	167
5.3.1	Community Energy Storage: Definition and Application	167
5.3.2	Community Energy Storage: Technology Status and Fit	168
5.3.3	Community Energy Storage: Technology Potential.....	170
5.3.4	Community Energy Storage: Regulatory Status and Policy Changes.....	171
5.3.5	Community Energy Storage: Benefits and Costs.....	173
5.3.6	Milestones and Next Steps for Community Energy Storage	177
CHAPTER 6: 2020 Energy Storage Vision and Recommendations		179
6.1	Energy Storage Vision for 2020	179
6.1.1	33 percent or More Renewable Energy Generation Under the 2020 Renewables Portfolio Standard.....	179
6.1.2	Implementation of the Smart Grid	180
6.1.3	Proliferation of Microgrids	180
6.1.4	Increased Residential Needs for On-Site Solar, Electric Vehicles, and Home Area Networks.....	181

6.1.5	Opening of Electricity Markets to Competition From Energy Storage and Incentive Programs	182
6.1.6	Natural and Human-Caused Disasters.....	183
6.1.7	Likely Price Decreases for Various Energy Storage Technologies.....	183
6.1.8	Future Research Needs to Implement the Vision.....	183
6.2	Policy Drivers for Energy Storage Deployment	185
6.2.1	CPUC and AB 2514 Target Potential.....	185
6.2.2	Additional Policies for Energy Storage Deployment.....	187
6.2.3	Agency Coordination	187
6.3	Conclusion	187
	Glossary.....	188
	References.....	191

LIST OF FIGURES

Figure 1: Comparison of Power and Discharge Time for Various Energy Storage Devices	15
Figure 2: Technical Maturity of Various Energy Storage Systems.....	16
Figure 3: Principles of Sodium-Sulfur Battery Operation	26
Figure 4: Structure of Li-air Battery.....	29
Figure 5: Cutaway Diagram of a Typical Pumped Hydro Plant.....	35
Figure 6: Proposed Pumped Storage Projects in the United States.....	37
Figure 7: Gravity Power Module™.....	39
Figure 8: CAES Plant With Underground Storage.....	41
Figure 9: Aerial View of CAES Plant in Huntorf, Germany	42
Figure 10: Aerial View of CAES Plant in McIntosh, Alabama.....	42
Figure 11: Conceptual AA-CAES System	44
Figure 12: Conceptual 2nd Generation CAES With Air Injection	46
Figure 13: Schematic of CAES With Bottoming Cycle and Humidification	47
Figure 14: Schematic of AA-CAES With Isobaric Storage.....	48
Figure 15: TES HVAC Unit With Cooling Coil Integrated Into Existing A/C.....	59
Figure 16: Hydrogen Electrolyzer/Fuel Cell Energy Storage System.....	62
Figure 17: Concept of a Neighborhood Using DESS.....	168

LIST OF TABLES

Table 1: Comparison of Various Flow Batteries	24
Table 2: Flywheel Shape Factors	51
Table 3: ARRA-Funded Energy Storage Technology Demonstration Projects	124
Table 4: Area and Frequency Regulation Performance Targets for Energy Storage	134
Table 5: Energy Storage Options for Frequency Regulation.....	135
Table 6: Adjustable Speed Pumped Storage Characteristics.....	136
Table 7: Renewables Integration Short-Term Metrics.....	149
Table 8: Renewable Energy Time Shift Applications – Long-Duration Metrics	150
Table 9: Bulk Energy Storage for Long-Duration Renewables Integration	152
Table 10: Application Value Estimates	163
Table 11: Distributed Energy Storage System Metrics.....	169
Table 12: DESS Uses and Benefits.....	174

EXECUTIVE SUMMARY

On April 12, 2011, California Governor Jerry Brown approved Senate Bill 2 Simitian Energy: renewable energy resources. Through this bill, California has set a 2020 goal of 33 percent electricity generation from renewable energy resources. The energy storage technologies' role to assist in the integration of variable renewable resources and the maintenance of a reliable and efficient electric grid takes on even greater importance as California progresses towards achieving this goal. Numerous policy and planning documents at the state and federal level have cited the importance of evaluating the potential benefits of energy storage in the generation, transmission, and distribution equation. On September 29, 2010, Assembly Bill 2514 (Skinner, Chapter 469, Statutes 2010) was signed into law directing the California Public Utilities Commission (CPUC) to convene a proceeding to determine energy storage procurement targets, if any, for investor-owned utilities. Under the statute, similar targets would be required for publicly owned utilities on a slightly later time frame. Meanwhile, electricity industry participants and technology developers have renewed efforts to develop, demonstrate, and implement a wide range of energy storage technologies.

A strategic analysis of the various energy storage technologies that may present options for California by 2020 has been conducted. The current status of energy storage technologies and many diverse policies affecting the deployment of energy storage in California has been analyzed, and critical technology gaps and research needs and policy reforms have been identified. This analysis provides a reference framework for the Energy Commission, CPUC, and other regulatory agencies to use as they work to develop commercially ready energy storage technologies that can be cost-effectively deployed in California to reduce costs to ratepayers, means to reduce emissions from fossil fuel generation, and opportunities to enable and accelerate the implementation of 33 percent renewable generation and its integration in California's electricity system.

Summary of Energy Storage Technologies

Overall Findings

Grid operators are already deploying large energy storage technologies, such as pumped hydroelectric and compressed air energy storage (CAES). There are significant challenges that must be solved in order to achieve desired storage goals. These goals include: finding appropriate sites for these facilities, obtaining necessary permits from various agencies and levels of government, overcoming regulatory hurdles associated with environmental review, meeting high capital costs for construction, and addressing a lack of access to transmission lines.

Manufacturers are demonstrating modular technologies, such as flywheels and various forms of batteries, in grid applications. Key challenges relate primarily to cost (although the modularity of the technologies may offer promise for cost reduction through volume production), to the ability to manufacture and deploy on a large-scale basis, to durability, and because of limited experience in grid applications.

Electrochemical Energy Storage

Batteries take in electricity from another producing source, convert the electricity to chemical energy, and store it as a liquid or solution. When operators need energy from the battery, an electric charge chemically converts the energy back into electrons, which then move back into a power line on the electric grid.

Batteries used to store power from renewable energy sources must be reliable, durable, and safe. Ultimately, affordability will be a key to widespread deployment. There are several promising battery technologies for grid energy storage applications including advanced lead-acid, lithium-ion, flow, and sodium-sulfur batteries.

Advanced Lead-Acid

During discharge in a traditional lead-acid battery, sulfuric acid reacts with the lead anode (positive electrode) and cathode (negative electrode) to create lead sulfate. The process reverses during charge. This conversion produces a short, powerful burst of energy, such as needed to jump start a vehicle. Over time, a lead-acid battery can lose its charge due to the gradual crystallization and buildup of lead sulfate within the battery's core. The corrosive acid also can eat away at a battery's core.

Lead-acid batteries are a mature and proven technology in use in a number of applications including frequency regulation, bulk energy storage for variable renewable energy integration, and distributed energy storage systems. Technology development of lead-acid battery technology is ongoing. Researchers have found that adding carbon to the battery seems to minimize or prevent the detrimental crystallization from occurring, thus improving the life cycle and overall lifespan of the battery. This technology has potential for storing renewable energy, but engineers must work to understand the technology's limitations and to find ways to bring down the cost.

Lithium-Ion

In a Lithium-ion (Li-ion) battery cell, positively charged lithium ions migrate through a liquid electrolyte (fluids that conduct electricity) while electrons flow through an external circuit. Both move back and forth from one side to the other. This movement creates and stores energy. Li-ion batteries store energy in various compounds, composed of layers of different elements, such as lithium, manganese, and cobalt.

Li-ion batteries are most commonly found in consumer products and electric vehicles. The relatively high energy and power capacity offered by Li-ion batteries, when compared to other technologies, has made Li-ion batteries the most promising option for transportation applications such as electric vehicles. Developers are considering and demonstrating Li-ion batteries in the same applications as lead-acid batteries.

Although Li-ion batteries have been a success for small electronics such as cell phones and laptop computers, larger versions are expensive, prone to overheating, and susceptible to electrical shorting. While engineers have made substantial progress over recent years toward

improving this technology, they will need to make further advances to extend life, improve safety, and reduce materials cost for this to be an attractive alternative for stationary applications.

Flow Batteries

A flow battery is a type of rechargeable battery that stores electrical energy in two tanks of electrolytes. When operators need energy, they pump liquid from one tank to another. During this slow and steady process, the technology converts the chemical energy from the electrolyte to electrical energy. When operators need to store energy, they reverse the process. The size of the tank and the amount of electrolyte the battery can hold determine the amount of energy the battery can store.

Flow batteries may be good candidates for backup energy storage up to 12 hours. They may also support integration of variable renewable energy. This technology has potential for grid applications if developers can manufacture it in a variety of sizes and make it portable and more affordable.

Sodium-Sulfur

The sodium-sulfur battery uses sulfur combined with sodium to reversibly charge and discharge, using sodium ions layered in aluminum oxide within the battery's core. The battery shows potential to store lots of energy in a small space. In addition, its high energy density and rapid rate of charge and discharge make it an attractive candidate for applications that require short, potent bursts of energy.

Sodium-sulfur batteries are a commercial energy storage technology with applications in electric utility distribution grid support, wind power integration, and high-value electricity services. However, materials are expensive, and safety concerns remain with respect to the high operating temperature of the battery. Researchers believe that modifying the shape of the battery can improve efficiency, lower the operating temperature, and reduce cost.

Mechanical Energy Storage

Operators can store energy in water pumped to a higher elevation using pumped storage methods, in compressed air, or in spinning flywheels.

Pumped Hydroelectric

Pumped hydroelectric uses two water reservoirs, separated vertically. During off-peak hours, operators pump water from the lower reservoir to the upper reservoir. The operators reverse the water flow to generate electricity.

Pumped hydroelectric energy storage is a large, mature, and commercial utility-scale technology that utilities use at many locations in the United States and around the world. This application has the highest capacity of the various energy storage technologies that experts have assessed. However, pumped storage plants generally entail long construction times and high capital expenditure for both construction of the plants and needed transmission lines.

Compressed Air Energy Storage

Compressed air energy storage technology stores low cost off-peak energy, in the form of compressed air, typically in an underground reservoir. Operators then heat the air with the exhaust heat of a standard combustion turbine and release it during peak load hours. Operators convert the heated air to energy through expansion turbines to produce electricity.

Compressed air energy storage systems suffer from reduced roundtrip efficiency associated with the cooling/reheating process. Air cooling between compression stages, although necessary, results in a loss of heat energy. Compressed air energy storage systems also produce carbon dioxide (CO₂) emissions from the reheating process, usually performed by direct combustion with natural gas. Some compressed air energy storage systems under development, such as advanced adiabatic compressed air energy storage, use a thermal energy storage unit that absorbs heat from the hot compressed air and saves the heat energy for later use to reheat the air before expansion, thus avoiding CO₂ emissions.

Flywheels

Flywheel energy storage works by accelerating a rotor (flywheel) to a very high speed, maintaining the energy in the system as rotational energy. When operators extract energy from the system, they reduce the flywheel's rotational speed as a consequence of the principle of conservation of energy. Adding energy to the system correspondingly results in an increase in flywheel speed.

Developers have matured flywheel technology through the advent of strong, lightweight materials, microelectronics, and magnetic bearing systems. Manufacturers are currently developing and demonstrating megawatt-scale flywheel plants with cumulative capacities of 20 megawatts to maintain a uniform quality electricity supply often also termed as frequency regulation applications. Overall, manufacturers have proven flywheels to be an ideal form of energy storage due to their high efficiency, long life cycle, wide range of operating temperature, and higher power and energy density on both a mass and volume basis. FESs still present high costs and technology limitations, including modest energy storage capacity and efficiency losses associated with the bearings.

Thermal Energy Storage

Thermal energy storage comprises a number of technologies that store thermal energy in energy storage reservoirs for later use. Operators can employ them to balance energy demand between daytime and nighttime. Operators maintain the thermal reservoir at a temperature above (hotter) or below (colder) than that of the ambient environment. The applications include concentrating sunlight to produce electricity from solar thermal energy during non-solar periods and the production of ice, chilled water, or salt solution at night, or hot water, which the devices use to cool / heat environments during the day.

Solar Thermal Storage Integration

The integration of thermal energy storage with solar energy offers a direct grid application for thermal energy storage. Unlike solar photovoltaic (PV) generation, concentrating solar power uses the thermal energy of sunlight to generate electricity. An advantage of concentrating solar power is the potential for storing solar thermal energy to be subsequently used during non-solar periods and to dispatch it as needed. Thermal energy storage allows concentrating solar power to achieve higher annual capacity factors from 25 percent without thermal storage up to 70 percent or more with thermal storage. Large concentrating solar power facilities using molten salt energy storage are in construction and/or operation in Spain and the United States. Plans are underway for facilities offering thousands of megawatts of additional generating capacity that will also use this storage technology.

Recent and ongoing improvements in solar thermal generation technologies, coupled with the need for more renewable sources of energy, have caused an increased interest in concentrating solar power. The key challenges lie in further cost reductions and perfecting designs to store solar heat later into the peak electrical period.

Thermal Storage for Heating, Ventilation, and Air Conditioning (HVAC)

In thermal energy storage systems, a device chills a storage medium during periods of low cooling demand and then uses the stored cooling to meet air-conditioning load or process cooling loads. The system consists of a storage medium, such as a water/ice system in a tank, a packaged chiller or built up refrigeration system, and interconnecting piping, pumps, and controls. Heating, ventilation, and air conditioning (HVAC) thermal energy storage systems shift cooling energy use to nonpeak times.

Thermal energy storage for commercial HVAC systems is a mature technology. The key to maximizing the effectiveness of such systems to shift cooling load and thus support the electric grid is appropriate engineering design and implementation.

Hydrogen as an Energy Storage System

Hydrogen as an energy storage system involves four processes. First, a device must produce hydrogen. In a grid energy storage application, the most appropriate production technology is the electrolysis of water using electricity. Second, after electrolysis produces the hydrogen, a device must store it, either in gaseous or liquid form. Third, in many instances, the hydrogen must be transported by truck or pipeline to a distant location. Fourth, to return electric power to the grid, the devices must convert hydrogen to electricity by either a fuel cell or a combustion engine or gas turbine generator.

The primary limitations of hydrogen energy storage systems include the maturity of the fuel cell technology; the durability of fuel cells and electrolyzers; and the capital cost of fuel cells, electrolyzers, and, to a lesser extent, storage vessels. The scale of fuel cells and electrolyzers with respect to grid storage applications and the efficiency of fuel cells and electrolyzers also limits the use of the technology, with roundtrip (electricity into the system to produce hydrogen

relative to the electricity produced by the hydrogen fuel cell) energy efficiencies of 31-35 percent.

Recommendations

Suggested Research and Development Priorities

- Bulk energy storage demonstrations for variable renewable energy integration (for example, pumped hydro, concentrating solar power, and solar thermal).
- Field demonstrations of modular energy storage technologies (for example, batteries, flywheels) in various grid applications.
- Evaluation/demonstration of aggregated storage, for example Thermal energy storage HVAC or electric vehicle (EV) batteries, especially in a smart grid scenario.
- Develop simulations, analytical tools, and intelligent control systems for planning, designing, and dispatching energy storage devices for multiple applications and benefits.
- Quantification of costs and benefits of energy storage in grid applications.
- Modeling of the impact of 33 percent renewable energy on California's electricity grid to determine needs for energy storage to support the grid, including sensitivity analysis to address cost variables of storage and other needed energy resources, environmental impacts, and emerging smart grid performance enhancements.

2020 Energy Storage Vision and Policy Priorities

As policy makers anticipate future grid needs and how energy storage can address them, they should consider a number of key developments that are likely to transpire between now and 2020 and that will influence the role of energy storage.

33 Percent or More Renewable Energy Generation Under the 2020 Renewable Portfolio Standard

The California Renewable Energy Resources Act (Senate Bill 2, Simitian Energy: renewable energy resources), signed by Governor Jerry Brown into law in April 2011, requires California to procure 33 percent of its electricity from renewable sources by 2020. However, integrating these variable and intermittent sources, such as solar and wind, will require an array of policy mechanisms. Policy makers should explore all cost-effective options, given California's environmental and greenhouse gas goals and need to avoid curtailment of renewable resources. Studies indicate that California may require between 3,000 to 4,000 megawatts of fast-acting energy storage by 2020 to integrate the projected increase in renewable energy.

Implementation of the Smart Grid

The deployment of Smart Grid, a network of interconnected electronically enhanced and digitally communicated and controlled electricity generation and transmission and distribution systems, in California may both improve and lessen the need for energy storage. Because utilities may be able to reduce end-user load with the new, smarter technology, they may not

require energy storage to shave peak load or maximize the efficiency of renewable energy electricity production. As customers, particularly from the business and industrial sectors, access real-time pricing information and identification of periods of peak electricity rates, they may consider purchasing on-site distributed energy storage systems, particularly batteries, to avoid peak charges. In addition, residential and business consumers can use the smart grid to increase their purchases of thermal energy storage technologies for HVAC systems. Utilities can also coordinate and aggregate these systems on the utility side of the meter, resulting in expanded markets for thermal energy storage technologies.

Proliferation of Microgrids

The rapidly growing market of *microgrids* for industrial/commercial customers requires extremely high reliability and availability of electricity supply. A microgrid is a local area network of interconnected electricity generation, transmission and distribution systems. Electric energy storage is a mandatory element in the design and architecture of a microgrid that does not rely on fossil fueled electricity generation. Energy storage is central to achieving the higher reliability and availability of energy supply, as well as maintaining the power quality on distribution circuits.

Increased Residential Needs for On-Site Solar, Electric Vehicles, and Home Area Networks

The proliferation of residential PV systems and the potential large-scale deployment of electric vehicles (EVs), as well as an increase in zero net energy buildings (meaning buildings requiring no external energy supply to meet their energy needs), have the capacity to fundamentally change the characteristics of the 2020 market for energy storage. Customers can potentially use behind-the-meter energy storage systems, particularly batteries, to capture and balance electricity from on-site renewable sources. They may also be able to use their battery systems to participate in power markets by providing grid services when not in use. Meanwhile, large-scale adoption of electric vehicles will likely drive down battery costs for lithium ion batteries as manufacturers increase production to meet demand and will provide opportunities for energy storage to lessen the stress on the distribution system from increased delivery of electric power. Vehicle owners in 2020 or sooner may be able to sell or otherwise recycle used batteries for second-use applications, such as providing distributed storage opportunities for the grid. They may also be able use their batteries to supply power to the grid often termed as *vehicle-to-grid* applications to offer ancillary services to utilities.

Opening of Electricity Markets to Competition From Energy Storage and Incentive Programs

The opening of various electricity markets to energy storage competition through the Federal Energy Regulatory Commission (FERC) and the California Independent System Operator (California ISO) rulings will likely spur greater deployment of technologies that can compete better in a less restrictive market. In addition, the California ISO could implement imbalance charges for intermittent resources, like wind and solar, by modifying rules governing the use of these resources potentially leading renewable energy suppliers to deploy energy storage technologies to reduce variability. Meanwhile, regulatory entities like the FERC and the California Public Utilities Commission can ensure greater certainty of cost recovery for investments in energy storage technologies by developing a valuation method to help monetize

the benefits provided by energy storage. Complementing these regulatory initiatives, the state and federal governments could promote incentive programs, either by developing new programs or by expanding existing ones, to help finance energy storage projects, bring down costs and help manufacturers provide better data to spur further investment by 2020. California could also promote energy storage deployment in 2020 through various policy mechanisms, most prominently the state's passage of AB 2514.

Natural and Human-Caused Disasters

Disasters over the next decade may spur greater investment in energy storage. Possible scenarios range from costly blackouts that jeopardize business functions and perishable goods storage to nuclear meltdowns, earthquakes, terrorist attacks, and other catastrophes. One response to these disasters could be regulations that require on-site backup energy storage to provide uninterrupted and continuous electricity and to help the grid to restart as quickly as possible.

Likely Price Decreases for Various Energy Storage Technologies

The result of the potential increase in investment and deployment of energy storage technologies, driven by the aforementioned policy changes and technological advances that may occur over the next decade, is that California and the nation will likely experience significant price drops in the cost of various energy storage technologies by 2020. Meanwhile, the likely competitor for energy storage over the next decade, natural gas, may not be able to maintain current prices and may experience price increases by 2020, leading to greater market opportunities for energy storage. In addition, the ability of energy storage technologies to harness and dispatch carbon-free renewable energy will become more important as the state implements carbon pricing and other legal and regulatory mechanisms aimed at reaching its ambitious greenhouse gas reduction goals. By 2020, the need for energy storage will be significantly greater than today.

Future Research Needs to Implement the Vision

This report cites a number of technical challenges that need further research and policy adjustments that the state, primarily through the California Energy Commission, should undertake to achieve the vision of energy storage in 2020. These needs include:

- A valuation method for energy storage that accounts for its costs and benefits to ratepayers and the public, given the state's energy and environmental goals.
- Research into communication technologies that enable participation and lower cost of participation by nonutility and end-user owners with grid connected energy storage technologies.
- Studies on how energy storage could operate in conjunction with demand response technologies.
- Studies to review the effects of recent tariff changes at the New York Independent System Operator, ISO New England, PJM Interconnection, and other grid operators on energy storage technologies attempting to compete in the area and frequency regulation market.

- Studies to review the technical requirements and cost implications of intrahour and shorter scheduling at California ISO in connection with regional balancing.
- Research into the potential effects of using energy storage for needed regulation over existing fossil fuel-based power plants.

Valuation Method

To determine the appropriate amount and role of energy storage by 2020, California should first determine a method to value or monetize the benefits provided by energy storage technologies, located on either side of the utility meter. The state lacks such a valuation framework. The high costs of current energy storage technologies and investment risk will persist without adoption of a valuation framework that monetizes the independent benefits and creates opportunities for cost recovery.

The CPUC is proceeding with a two-phase rulemaking process under AB 2514, with a second phase addressing energy storage application values, costs, and means to determine cost-effectiveness. A critical feature of this challenge is how to allocate the costs and benefits of storage across the range of services that are affected, including generation, transmission, distribution, and regulation. Some benefits may not be aggregated due to institutional barriers or technical/operational conflicts. Policy makers will need to devise a framework that addresses the multiple values and potential overlapping nature of energy storage's benefits.

Considerations that the CPUC will need to address include:

- Grouping operational uses and associated benefits, such as by application(s) and location. This method should use the most promising applications, such as the three identified in this report: frequency regulation, integrating variable renewable energy, and developing community or distributed energy storage systems.
- Prioritizing certain applications to meet the objectives set forth by AB 2514.
- Compensating energy storage owners/ operators for services not covered by California ISO markets.
- Determining which services/applications and related value streams may be aggregated to maximize financial return to a storage system without double-counting benefits or committing the same resource to incompatible uses at one time.

Policy makers should consider broad categories of benefits that could be monetized in the valuation method. For example, societal benefits include reduced reliance on fossil fuel and increased energy security, reduced criteria air pollutant and greenhouse gas emissions, and achieving superior operation of the existing generation fleet. In addition, energy storage can provide transmission and distribution deferral and other avoided costs, such as for variable distributed generation integration. Additional value for customers could come from avoided transmission and distribution fees, such as when large distributed energy storage modules provide on-peak energy closer to load, relieving some of the on-peak energy flow in congested transmission lines.

Key Energy Storage Policies

The state can boost appropriate deployment of energy storage by setting targets for procurement under AB 2514, ideally in a two-phase process with short-term and long-term targets. Setting procurement targets would ensure that conventional energy storage technologies do not have an unfair advantage over newer or less proven options that may nonetheless become more cost effective over time. Should the state determine that targets are not appropriate, numerous policy actions at the state and federal level still can unleash incentives for energy storage procurement, such as opening ancillary services and capacity markets to energy storage, expanding existing incentive programs to cover energy storage, and focusing additional research and development dollars on energy storage demonstration projects that prove grid applications and seek ways to reduce costs.

The CPUC can also affect the market for energy storage in the following key ways:

- Implement energy storage procurement targets under AB 2514.
- Ensure the Self-Generation Incentive Program covers energy storage resources, providing potentially crucial financial incentives for energy storage investment.
- Refine its Resource Adequacy (RA) program, which ensures that California ISO has access to sufficient resources to operate the grid safely and reliably and promotes the siting and construction of new resources needed for future reliability. All load-serving entities (LSE) within the CPUC's jurisdiction are subject to the determined RA requirements. The CPUC could promulgate rules to allow certain categories of energy storage procurement to count toward an LSE's RA obligations.
- Use existing proceedings related to the development of the smart grid, permanent load shifting, demand response, long-term procurement process, and alternative-fueled vehicles to explore the cost-effective promotion of energy storage technologies as they relate to these proceedings.
- Implement real-time pricing and strong price differentials between peak and off-peak rates to boost the market for peak-load shaving technologies.
- Encourage the California ISO and FERC to open markets to competition from energy storage.
- Develop a valuation methodology for energy storage that accounts for its costs and benefits to ratepayers and the public, given the state's energy and environmental goals. This method could value technologies based on the most promising applications and ensure that benefits to additional applications are appropriately counted. This report identifies three potentially promising applications for energy storage: frequency regulation, integrating variable renewable energy, and developing community or distributed energy storage systems.

California's policy makers will need to balance the promotion of energy storage with concerns about containing costs and not favoring less optimal technologies. They will also need to ensure proper agency coordination, given overlapping jurisdictions, as they implement a strategic vision for deploying energy storage in California by 2020 to realize the benefits of energy storage to ratepayers such as clean low-cost renewable electricity and reliable and sustainable energy system in California.

The California Energy Commission can help encourage the use of energy storage technologies by using public interest energy research funds to develop, improve and demonstrate energy storage technologies. The benefits of energy storage technologies should be viewed as a key element in ensuring electrical grid stability in everyday operations, helping to integrate the use of intermittent energy resources into the electrical grid, providing backup energy storage to ensure uninterrupted electricity in the event of a catastrophic event, and helping business and residential customers achieve zero net-energy use goals.

CHAPTER 1: Introduction: The Importance of Energy Storage and Technology Status

The Importance of Energy Storage

California's ambitious clean energy agenda places it at the forefront of efforts nationally and globally to increase efficiency, reduce greenhouse gas emissions, and shift to a cleaner and more sustainable energy future. The changes taking place to implement this vision are wide ranging and encompass legislative and regulatory action, private sector and industry initiatives, public-private partnerships, and inter-agency coordination and collaboration. As the state progresses towards its 2020 targets for substantially increased renewable energy resources and reduced greenhouse gas emissions, the potential for energy storage to assist in the integration of renewable resources and the maintenance of a reliable and efficient electric grid takes on great significance.

Certain types of energy storage, such as pumped hydro, have long been part of the electricity grid, and numerous policy and planning documents, at the state and federal level, have cited the importance of evaluating the potential benefits of energy storage in the generation, transmission, and distribution equation. These include the California Energy Commission's (Energy Commission) 2009 Integrated Energy Policy Report (IEPR) and 2011 IEPR Scoping Document, the joint energy agencies California's Clean Energy Future – Collaborative Vision for 2020, and President Obama's Policy Framework for the 21st Century Grid released by the Executive Office. The United States Department of Energy has awarded hundreds of millions of stimulus dollars to support private and public sector research in energy storage and smart grid technologies. And the Federal Energy Regulatory Commission (FERC) has undertaken action to enable greater participation by energy storage and other non-generation assets.

In September, 2010, the California legislature enacted Assembly Bill 2514 (AB 2514 [Skinner, Chapter 469, Statutes 2010]), directing the California Public Utility Commission (CPUC) to convene a proceeding by March 1, 2012 to determine energy storage procurement targets, if any, for investor-owned utilities. Under the statute, similar targets would be required for publicly-owned utilities on a slightly later time frame. In December 2010, the CPUC issued an Order for Rulemaking Pursuant to AB 2514, initiating the process more than a year ahead of the statutory deadline. The adoption of targets under AB 2514 could potentially impact the electric utilities' procurement planning processes, which already are subject to the April 2011-enacted California Renewable Energy Resources Act, Senate Bill 2 (SB 2) requiring 33 percent renewable electricity generation by 2020. The procurement planning process also must take into account impending regulations to be promulgated by the California Air Resources Board (ARB) under AB 32, the state's greenhouse gas emissions reduction law.

This report, a project of the California Energy Commission, presents a strategic analysis of energy storage technology for California by 2020, in part to inform the AB 2514 process. The report assesses current energy storage technologies and the diverse policies affecting deployment in California, outlining critical technology gaps and research needs and policy reforms. It also provides a framework for the Energy Commission, CPUC, and other regulatory agencies, as they create a roadmap for how commercially ready energy storage technologies can be cost-effectively applied in California to reduce costs to ratepayers, reduce emissions from fossil fuel generation, and enable and accelerate the implementation of more renewable generation and its integration in California's electricity system.

In addition, a primary objective of this report is to determine the current status of energy storage technologies and identify related issues, research gaps, barriers, and opportunities as well as specific targets or milestones and specific actions necessary for development and deployment of energy storage technologies in California. Under this direction, the authors of this report worked with the PIER Energy Storage Program Team, industry experts, utility representatives, and other leading practitioners to identify targets and milestones, as well as specific actions necessary for development and deployment of energy storage technologies in California and articulate it in the PIER Energy Storage Program Strategic Vision. The authors also presented findings from the draft report at two CPUC hearings on energy storage and one Energy Commission meeting, as well as in a workshop for key stakeholders. The purpose of the targets and milestones is to clearly identify the 2020 Energy Storage goals over time that the RD and D activities must be working toward achieving. The project advisory committee members, listed in the acknowledgments, provided critical input to the findings of this report. All mistakes and conclusions, however, are ultimately those of the authors.

The Energy Commission's ultimate goal is to establish a 2020 Energy Storage Vision for the state. As such, the agency initiated this report specifically to develop scenarios for how energy storage maybe applied throughout California's electric power system and to estimate the costs and benefits of such a vision as compared to a scenario without deployment of energy storage. The Energy Commission envisioned this report as a useful planning tool to help the CPUC and other regulatory agencies develop a vision for how commercially ready energy storage technologies can be cost effectively applied in California to reduce costs to ratepayers, reduce emissions from fossil fuel generation and enable and accelerate the implementation of more renewable generation and its integration in California's electricity system. Given the complexity of the regulatory and market structures that affect energy storage deployment in California, as well as the wide range of commercially available and emerging energy storage technologies and grid applications they may serve, this report will hopefully serve as a

significant step toward developing a 2020 Energy Storage Vision that the public and private sectors alike can continue to bolster with follow-on research.

Technology Status

Any discussion of a strategic vision for energy storage must begin with an assessment of the diverse technologies that comprise the sector. To assess the potential for future deployment of energy storage, policy makers and the public need an understanding of the current state of these technologies and the likely technological advancements that may occur in the near term. As such, this technology status chapter surveys the various energy storage technologies, describing how they function, assessing their current state of development, and citing any critical research and development needs to advance the technology and lower costs. In addition, this section presents some cost data on existing technologies based on their performance in the field.

The chapter is divided into electrochemical, mechanical, thermal and hydrogen energy storage, under which exists a multitude of separate technologies. Each technology has its strengths, limitations, and appropriateness for the large and diverse set of applications for energy storage. This study does not attempt to pick the energy storage technologies that may commercially penetrate these application markets. Although this chapter references previous analyses that align particular technologies' rated capacity with either storage and discharge time and that suggest suitability to a specific application, the inclusion of these references does not indicate a preference in this report for the particular companies or technologies involved.

Figure 1 compares the power and discharge time of various energy storage devices (note that this graph does not reflect the latest advances in energy storage technology capabilities but is representative nonetheless).

Figure 1: Comparison of Power and Discharge Time for Various Energy Storage Devices

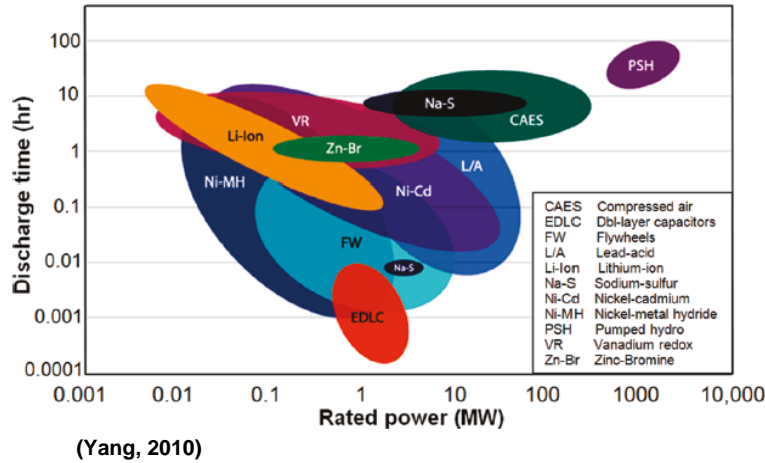

Scientists classify energy storage applications by the same criteria, power and time of discharge. They consider those applications that charge and discharge on a time scale less than an hour to be ‘power applications,’ while they call those that charge and discharge over times longer than one hour ‘storage applications’ (Nexight Group, 2010a, p. 7).

There are a wide range of energy storage devices currently available, and many have been in operation for decades. Figure 2 below is from a report by Chen et al., 2009 showing the maturity status of many major energy storage technologies¹. Analysts expect advancements in energy storage to occur with the maturation of new technologies, such as metal air batteries, and the application of new materials and designs to proven technologies, like lead-acid.

¹ The definition of “maturity” as a metric of technology status is held in the eye of the customer. The historically risk-averse utility sector in a regulated environment has a different definition of “maturity” than the unregulated customer or energy services provider. This report will express maturity in MW-years of commercial operations of the existing state of the art for each particular EES technology.

Figure 2: Technical Maturity of Various Energy Storage Systems

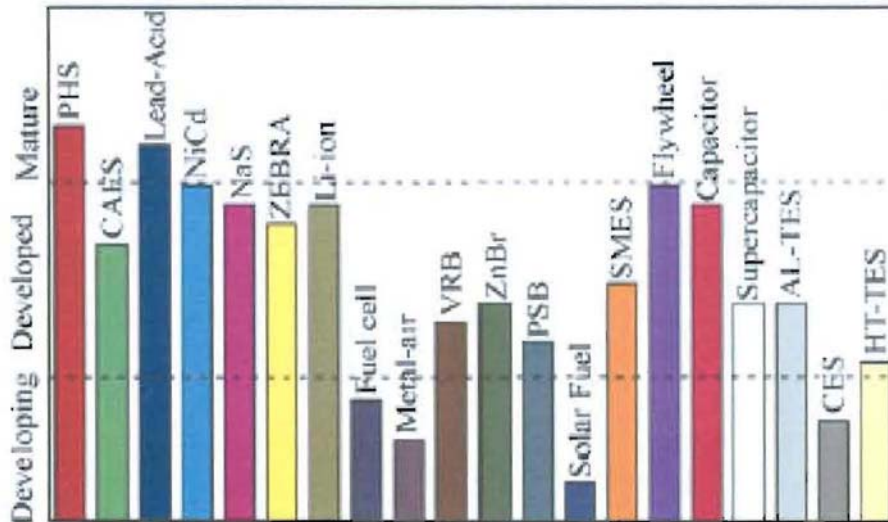

(Chen et al., 2009)

1.1 Electrochemical Energy Storage

Scientists classify electrochemical energy storage (EES) devices in terms of power, often normalized by weight (such as kilowatts per kilogram) or volume (such as kilowatts per liter) to enable performance comparisons, and the discharge time for which the devices can sustain that power. The energy that the devices store is the product of the power and discharge time.

All EES devices are composed of two basic parts, the electrodes and the electrolyte. Conventional battery technologies store energy in the electrodes, while ion transport, the essential feature of electrochemical processes which creates the flow of electricity, occurs through the electrolyte. Flow batteries are rechargeable batteries in which electrolyte containing one or more dissolved electro-active species flows through an electrochemical cell that converts chemical energy directly to electricity. Flow batteries differ from more conventional batteries in that they store energy in the electrolytes. Advances in materials, and especially in controlling the interfaces between the electrodes and electrolyte, will drive improvements in EES performance. Potential opportunities also exist for hybridization of devices. For example, engineers have made achievements in combining the high energy density of batteries with the high power density of capacitors, which are devices that store electric surface charges for fast reacting power discharge.

Device improvements can increase the specific power output of the device or the specific energy capacity. However, making wide-scale adoption of EES economically feasible will require improvements in both energy and power density. Scientific research in EES is often concerned

with energy and power density normalized by units of weight or volume. Scientists choose these units in part because in the traditional EES applications, such as portable electronics and transportation, the weight and volume of a device can affect its usefulness. However, for stationary EES applications, such as grid stability, load shifting and renewables integration, weight and volume are not such important parameters. Instead, cost, cycleability (the capability to complete numerous charge and discharge cycles), and reliability are the key parameters for EES on the grid. For instance, if electric power companies use EES in transmission as a substitute for upgraded power lines, the reliability of the EES system must match the reliability of power lines, which is 99.9percent (Nexight Group, 2010a, p. 12). Thus, over the next decade, engineers must make advances not only in the physics and chemistry of EES, but also in improving the manufacturing processes to produce reliable and long-lasting devices more cheaply. They should also incorporate materials into the device designs that are environmentally benign and abundant.

1.1.1 Lead-Acid Batteries

1.1.1.1 *Description of Technology*

Lead-acid batteries are the most mature of all EES systems that exist today and offer an immediate solution while engineers continue to develop other EES systems. Lead-acid batteries are particularly attractive for early deployment due to their relatively low cost, ease of manufacture, rapid electrochemical reaction kinetics, and good cycle life under controlled conditions (Huggins, 2010, p.237).

1.1.1.2 *Technology Status*

Although lead-acid is the most commercially mature rechargeable battery technology in the world, the technology is undergoing a period of rapid development amid renewed interest. The maximum theoretical specific energy (the energy content per unit mass) of fully compounded active material in a lead acid battery is 171 Watthours per kilogram (Wh/kg) (Huggins, 2010, p. 239). However, conventional lead acid batteries lose much of this potential due to the need for internal connectors and grids to structurally support the heavy lead material. Conventional lead acid batteries typically achieve 20-30 Wh/kg and possibly much more by replacing or eliminating the non-active lead components. Maintenance free valve-regulated lead-acid (VRLA) batteries, also known as sealed lead acid batteries, have largely replaced conventional high maintenance “flooded cell” batteries in a variety of applications, including automotive, marine, telecommunications, and uninterruptible power supply (UPS) systems. However, for large scale grid storage, many lead acid experts and manufacturers still view flooded lead-acid batteries as the best alternative.

More recently, engineers have made significant advances in the chemistries and formulations used and even the basic architecture. Assuming 2 Volts (V) per cell, the maximum theoretical

specific energy of lead-carbon batteries is 171 Wh/kg (Huggins, 2010, p. 239). However, due to the need for water and other components, working values for specific energy vary from 30-50 Wh/kg. The power density of lead-acid batteries has reached 4 kiloWatts per kilogram (kW/kg) over 10 seconds in prototype batteries (Wagner, 2002).

The lifetime of lead-acid batteries varies significantly depending on the application, discharge rate, and number of deep discharge cycles, which can reduce life. A 1 megawatt (MW)/1.5 Megawatt hours (MWh) lead-acid system by GNB Industrial Power and Exide has been operating for 12 years at a remote island location in Alaska. In that project, the battery system exhibited very little visible degradation upon post-test analysis, and operators replaced it in 2008. Operators have deployed other lead-acid energy systems in sizes of 10 to 20 MW. The cost of lead can influence the battery price. For bulk energy storage, costs for lead-acid batteries range from \$425-\$980 /kWh, depending on efficiency, capacity, and power (EPRI, 2010a, p. 4-25).

1.1.1.3 Technology Limitations and Opportunities

Because grid operators could not control the cycle conditions for a renewable energy- intensive grid application (particularly for variable sources such as solar and wind), traditional lead-acid batteries would experience short cycle life and significant maintenance requirements.

Manufacturers have made improvements to lead-acid systems by using carbon-enhanced electrodes to create advanced lead-carbon batteries. Adding carbon components to the electrodes does not change the basic electrochemistry but acts to increase the power output and reduce detrimental chemical reactions within the battery cells (Nexight Group, 2010a, p. 18).

Manufacturers can also obtain additional performance enhancement in lead-acid batteries by changing the electrolyte material.

Key issues for the deployment of lead acid batteries are:

- Need for careful thermal management, including a high likelihood for active cooling.
- Need for custom-designed grid storage system using lead acid batteries.

1.1.2 Nickel-Based Batteries

1.1.2.1 Description of Technology

Nickel-based batteries come in the form of Nickel/Cadmium (NiCad) and Nickel/metal hydride (NiMH) systems. The NiCad battery uses nickel oxide hydroxide as the positive electrode and metallic cadmium as the negative electrode. The NiMH battery has a number of technical features similar to a NiCad battery. However, the NiMH battery uses a hydrogen-containing alloy for the negative electrode instead of cadmium, thus changing the electrochemistry and resulting in two to three times the energy storage capacity. NiMH batteries are best suited for applications such as hybrid electric vehicles, where they are already in widespread use.

1.1.2.2 Technology Status

Currently, the largest application for NiCad batteries is in portable electronics, similar to primary batteries for the same devices. Compared with lead-acid batteries, NiCad batteries have longer cycle life, higher energy densities, and lower maintenance (Nair and Garimella, 2010). Nickel metal hydride batteries are a feasible alternative to NiCad batteries due to their better performance and environmental benefits. In comparison to lead-acid and NiCad batteries, NiMH does not contain toxic substances (cadmium or lead). The energy density of NiMH cells is 25–30 percent better than NiCad cells (Crompton) but well below rechargeable Li-ion cells (Nexight Group, 2010a, p. 21).

1.1.2.3 NiCad Battery Technology Limitations and Opportunities

Many of the advancements in NiCad batteries have been in device architecture, using the jelly-roll design that is similarly akin to primary batteries of the same type. In this design, manufacturers lay down an anode (negative electrode) material, apply a separator, and then lay down a cathode (positive electrode) material. They then roll this assembly into a cylinder, leading to the term “jelly roll.” Although NiCad batteries are relatively inexpensive and quite reliable for a number of applications, especially consumer products, they face some of the same limitations as lead-acid batteries: the need for large volumes, toxicity, and the severity of the self-discharge, a phenomenon in batteries in which internal chemical reactions reduce the stored charge in the battery without any connection to the electrodes. Therefore, while NiCad batteries are a potentially competitive replacement for lead-acid batteries in the near term, they are not a suitable long-term solution.

1.1.2.4 NiMH Battery Technology Limitations And Opportunities

NiMH batteries, like NiCad batteries, also suffer from severe self-discharge, making them inefficient for long term energy storage. As a result, NiMH batteries represent another possibility for interim applications but not for long term solutions.

1.1.3 Lithium-Ion Batteries

1.1.3.1 Description of Technology

Lithium (Li) is an attractive material for batteries because it has a high reduction potential, which is a tendency to acquire electrons, (-3.04 Volt (V) versus a standard hydrogen electrode) and is lightweight. However, Li is also highly reactive with water and oxygen, so Li batteries must use non-aqueous electrolytes such as lithium hexafluorophosphate (LiPF₆), lithium tetrafluoroborate (LiBF₄), and lithium perchlorate (LiClO₄), which are dissolved in an organic solvent instead of water. Because these electrolytes, like Li, react explosively with water, Li batteries must remain tightly sealed from the environment during manufacture, use, and disposal.

In a Li-ion battery, lithium ions move from the negative electrode to the positive electrode during discharge, and then back to the negative electrode when charging. In a conventional Li-ion cell, manufacturers produce the negative electrode from carbon (most commonly graphite), while the positive electrode is a transition metal oxide which undergoes oxidation-reduction or redox reactions, which are the fundamental reactions that transfer electrons between species in electrochemical cells (the standard being lithium cobalt oxide). The electrolyte that separates the two electrodes is a lithium salt dissolved in an organic solvent.

1.1.3.2 Technology Status

Rechargeable Li-ion batteries are commonly found in consumer electronic products, which make up most of the worldwide production volume of 10 to 12 Gigawatt hours (GWh) per year. Already commercial and mature for consumer electronic applications, plug-in hybrid electric vehicle (PHEV) and -electric vehicle (EV) manufacturers are positioning Li-ion to be the leading technology platform for their products, which will use larger-format cells and packs with capacities of 15 to 20 kWh for PHEVs and up to 50 kWh for all-electric vehicles (EPRI, 2010a, p. 4-17).

Compared to the long history of lead-acid batteries, Li-ion technology is relatively new. Many different Li-ion chemistries exist, each with specific power versus energy characteristics. Analysts expect the EV and energy storage markets to benefit from the high-volume production and safety experience that large-scale lithium-ion battery manufacturers have gained through producing batteries for consumer electronics. Large-format batteries are currently the subject of intense R and D, scale-up, and durability evaluation for near-term use in hybrid electric vehicles. However, these cells are only available in limited quantities as auto equipment manufacturers increase production of PHEVs and EVs. However, Li-ion battery original equipment manufacturers (OEMs) are increasing their global manufacturing capabilities to meet the future needs of the automotive market. Analysts anticipate the manufacturing scale of Li-ion batteries (estimated to total approximately 35 GWh by 2015) to result in an over-capacity of supply and lower-cost battery packs, which could be integrated into systems for grid-support applications of energy storage duration (EPRI, 2010a, p. 4-17).

The high energy density and relatively low weight of Li-ion systems make them an attractive choice for vehicles and other applications where space and weight are important. Given their attractive cycle life and compactness, in addition to high roundtrip energy efficiency that exceeds 85 percent–90 percent, Li-ion battery manufacturers are demonstrating their products for several utility grid-support applications, including distributed energy storage systems (DESS) at the community scale, transportable systems for grid-support, commercial end-user energy management, home back-up energy management systems, frequency regulation, and wind and photovoltaic smoothing (EPRI, 2010a, p. 4-18).

Although their operating voltage, specific energy, lifetimes, and safety varies, lithium ion batteries are relatively light, compact, and work with a voltage on the order of 4 V with a specific energy ranging between 100 Wh/kg and 150 Wh/kg (Scrosati and Garche, 2010), with a theoretical specific energy of 450 Wh/kg (Beck and Rüetschi, 2000). A recent demonstration involving the 8 MW/32 MWh Southern California Edison Tehachapi Project has a total project cost of \$57.2 million (with the Energy Commission's PIER program providing over \$6 million in funding). The project costs include all expenses, such as the building, the interconnection, and operation and maintenance (O and M). In this project, the battery energy cost is then ~\$1,788/kWh. Cost projections for utility-support applications or commercial applications, where these batteries are currently better suited, range from \$900-\$1,900/kWh (EPRI, 2010a, p. 4-24).

1.1.3.3 Technology Limitations and Opportunities

Recent improvements in Lithium-ion batteries technology have been primarily in the design of novel, three-dimensional architectures and the use of nanoscale materials. These approaches have been employed to improve power. To improve the specific energy, engineers have been actively researching and developing the replacement of graphite and of lithium cobalt oxide with higher capacity and lower cost electrode materials. Engineers are currently exploring Lithium-metal alloys as a replacement for the carbon electrode. For the positive electrode, manganese-based compounds and lithium metal phosphates have shown promise. All of these initiatives are at the development stage.

Engineers are also examining the replacement of the electrolyte solutions with safer and more reliable alternatives. Concerns with the current standard electrolyte, a LiFP6-organic carbonate solution, include:

- the narrow voltage stability, preventing the use of higher voltage cathodes
- the high vapor pressure and flammability
- the toxicity of LiFP6

Efforts to solve these issues include (i) additives to build-up a stable solid-electrolyte interface and/or enhance its thermal stability; (ii) redox additives to protect from overcharge; (iii) shut-down separators to prevent thermal runaway; and (iv) lithium salts as an alternative to LiPF₆, to reduce toxicity (Scrosati and Garche, 2010). Engineers may also be able to develop a polymer electrolyte, allowing for a solvent-free, Li-ion conducting membrane. Overall, Li-ion batteries are a promising mid-term solution and a potential longer-term solution.

Another approach to reducing costs of Li-ion batteries would be through a "second use." Once Li-ion batteries for plug-in hybrid and electric vehicles (PHEV/EV) degrade to 70percent-

80percent of their original power/capacity, they are no longer sufficient for automotive use. However, electric power companies could reuse these aged batteries in other applications. Such second-use applications could increase the total lifetime value of the battery and thus reduce its cost to the automotive user. Given that the high cost of the batteries significantly reduces the affordability of PHEV and EVs, sale of the batteries for reuse could boost the PHEV and EV market by driving down overall costs. Possible additional secondary uses for Li-ion batteries include residential and commercial electric power management, power grid stabilization to help provide reliable electricity to users, and renewable energy system firming. The latter involves using batteries to make the power provided by variable resources such as wind and solar energy more useable for the grid. The DOE National Renewable Energy Laboratory (NREL) will partner with an industry-academia team led by the California Center for Sustainable Energy (CCSE) to investigate secondary applications for aged battery packs from electric and hybrid electric vehicles (Neubauer and Pesaran, 2010).

1.1.4 Flow Batteries

1.1.4.1 *Description of Technology*

A flow battery is a form of rechargeable battery in which electrolyte containing one or more dissolved electro-active species flows through an electrochemical cell that converts chemical energy directly to electricity. When the devices introduce these materials into the cell during operation, they produce an oxidation-reduction (redox) reaction. A membrane or other separator isolates the electrolytes to allow for ion transport. The devices store additional electrolyte externally, generally in tanks, and usually pump it through the cell (or cells) of the reactor. Flow batteries can rapidly "recharge" by replacing the electrolyte liquid (in a similar way to refilling fuel tanks for internal combustion engines) while simultaneously recovering the spent material for re-energizing. This differs from more conventional storage batteries, which store the electrolytes within the battery cell itself.

1.1.4.2 *Technology Status*

A number of potential redox flow battery chemistries exist and are highlighted in Table 1. Vanadium redox battery technology is one of the most mature types of flow battery systems available. Flow batteries store energy as charged ions in two separate tanks of electrolytes, one of which stores electrolyte for positive electrode reaction while the other stores electrolyte for negative electrode reaction. Vanadium redox systems use one common electrolyte, which provides potential opportunities for increased cycle life. When power companies need electricity, the electrolyte flows to a redox cell with electrodes, generating current. Operators can reverse the electrochemical reaction by applying an over-potential, as with conventional batteries. This application allows the system to repeatedly discharge and recharge. Like other flow batteries, many variations of power capacity and energy storage are possible depending on the size of the electrolyte tanks (EPRI, 2010a).

Manufacturers can design vanadium redox systems to provide energy for two hours to more than eight hours, depending on the application. Manufacturers claim that cycling does not strongly affect the lifespan of flow-type batteries because the devices store the electrolytes externally. Suppliers of vanadium redox systems estimate the lifespan of the cell stacks to be 15 or more years, while the balance of plant and electrolyte can have lifetimes of over 25 years. System suppliers also say they have achieved cycling capability of 10,000 or more cycles at 100percent depth of discharge. The physical scale of vanadium redox systems tends to be large due to the high volumes of electrolyte required when sized for utility-scale (megawatt-hour) projects. Vanadium redox battery costs are in the range of \$620-\$740 /kWh for bulk energy storage applications (EPRI, 2010a, p. ES-18).

For bulk energy storage applications, Zn/Br batteries are currently in the demo stage of development. For example, the Energy Commission's PIER program helped fund a Primus Power Corporation 25 MW/75 MWh grid-connected Zinc-based flow battery energy storage system to provide renewable firming, strategic local peak shaving, automated load shifting, and ancillary services. Recent studies project the cost of these projects at \$290-\$350/kWh (EPRI, 2010a, p. ES-18). Analysts project Fe/Cr batteries, currently emerging into commercial demonstrations, to cost \$360-\$380/kWh (EPRI, 2010a, p. ES-18). As in vanadium redox systems, the Zn/Br battery charges and discharges in a reversible process as the device pumps electrolytes through a reactor vessel. While the technology lacks significant field experience, vendors claim estimated lifetimes of 20 years, long cycle lives, and operational ac-to-ac efficiencies of approximately 65percent to 70percent (EPRI, 2010a, p. 4-25).

Table 1: Comparison of Various Flow Batteries

System	Reactions	E_{cell}°	Electrolyte
Redox			Anode/Cathode
All Vanadium ³	Anode: $V^{2+} \xrightleftharpoons[discharge]{charge} V^{3+} + e^{-}$ Cathode: $VO_2^{+} + e^{-} \xrightleftharpoons[discharge]{charge} VO^{2+}$	1.4 V	H ₂ SO ₄ /H ₂ SO ₄
Vanadium-Polyhalide ⁵	Anode: $V^{2+} \xrightleftharpoons[discharge]{charge} V^{3+} + e^{-}$ Cathode: $\frac{1}{2} Br_2 + e^{-} \xrightleftharpoons[discharge]{charge} Br^{-}$	1.3 V	VCl ₃ -HCl/NaBr-HCl
Bromine-Polysulfide ⁶	Anode: $2 S_2^{2-} \xrightleftharpoons[discharge]{charge} S_4^{2-} + 2e^{-}$ Cathode: $Br_2 + 2e^{-} \xrightleftharpoons[discharge]{charge} 2 Br^{-}$	1.5 V	NaS ₂ /NaBr
Iron-Chromium ⁷	Anode: $Fe^{2+} \xrightleftharpoons[discharge]{charge} Fe^{3+} + e^{-}$ Cathode: $Cr^{3+} + e^{-} \xrightleftharpoons[discharge]{charge} Cr^{2+}$	1.2 V	HCl/HCl
H ₂ -Br ₂ ⁸	Anode: $H_2 \xrightleftharpoons[discharge]{charge} 2H^{+} + 2e^{-}$ Cathode: $Br_2 + 2e^{-} \xrightleftharpoons[discharge]{charge} 2Br^{-}$	1.1 V	PEM*-HBr
Hybrid			
Zinc-Bromine	Anode: $Zn \xrightleftharpoons[discharge]{charge} Zn^{2+} + 2e^{-}$ Cathode: $Br_2 + 2e^{-} \xrightleftharpoons[discharge]{charge} 2 Br^{-}$	1.8 V	ZnBr ₂ /ZnBr ₂
Zinc-Cerium ⁹	Anode: $Zn \xrightleftharpoons[discharge]{charge} Zn^{2+} + 2e^{-}$ Cathode: $2Ce^{4+} + 2e^{-} \xrightleftharpoons[discharge]{charge} 2Ce^{3+}$	2.4 V	CH ₃ SO ₃ H (both sides)

*Polymer Electrolyte Membrane

(Nguyen and Savinelli, 2010)

1.1.4.3 Technology Limitations and Opportunities

Flow batteries are an attractive energy storage option for the grid because of their ability to store large amounts of energy and their potential long cycle life and high efficiency. However, the technology is still young with significant cost barriers. For flow batteries that employ different active species in the anode and cathode electrolytes in particular, cross-transport through the cell can lead to efficiency loss and contamination. Flow batteries can also suffer from thermal and chemical stability problems in the membranes and electrolytes, which can impact operating range and battery life. Additionally, the stack design of flow batteries may present a scaling problem, particularly the generation of electrical shorts. Leaks, pump reliability, and seal and tubing life are also important issues for flow battery technologies. Finally, the delivery system for the electroactive materials needs improvements in robustness and cost. To address these issues, engineers must make improvements to the membrane, stack design, monitoring systems, novel materials and chemistry, and cell design.

The relatively short field experience of flow batteries suggest that the claims of 20 - 30 year lifetimes are still to be proven.

1.1.5 Sodium-eta Alumina Batteries

1.1.5.1 Description of Technology

Sodium (Na) is a good battery material because it has a high reduction potential, meaning a tendency of a chemical species to acquire electrons (-2.71V versus a standard hydrogen electrode), is lightweight, non-toxic, inexpensive, and relatively abundant. However, sodium is also highly reactive with water and oxygen. As a result, engineers must tightly seal sodium batteries from the environment. In contrast to other battery systems, sodium beta- alumina batteries consist of liquid electrodes and a solid electrolyte separator. These batteries operate at elevated temperatures (300 to 350 °C) to ensure that the electrolyte (sodium beta-alumina) and the electrodes have high sodium ion conductivity to enable the flow of electrons and that the electrodes have low viscosity to facilitate the flow of reactants enabling sodium batteries to work. Sodium beta-alumina batteries discharge by transporting sodium ions from a liquid sodium anode, through a beta-alumina solid electrolyte (BASE), and into a cathode compartment. The cathode is either sodium polysulfide (Na-S battery) or a porous metal/metal halide structure impregnated with molten NaAlCl₄ as a second electrolyte. The latter, Na-metal halide batteries, have a higher cell voltage compared to Na-S (2.58 V at 300 °C versus. 2.21 V at 350 °C). Commercially available sodium-beta batteries have energy densities around 100 Wh/kg. Figure 3 shows the charging and discharging processes for a Na-S battery; the round trip efficiency between charging and discharging the battery is up to 90percent. BASE is an excellent sodium ion conductor at elevated temperatures, and its low electronic conductivity prevents electrical shorting. Because sodium-beta batteries must operate at high temperatures, 300-350 °C, thermal management is an integral part of any sodium-beta battery system.

Figure 3: Principles of Sodium-Sulfur Battery Operation

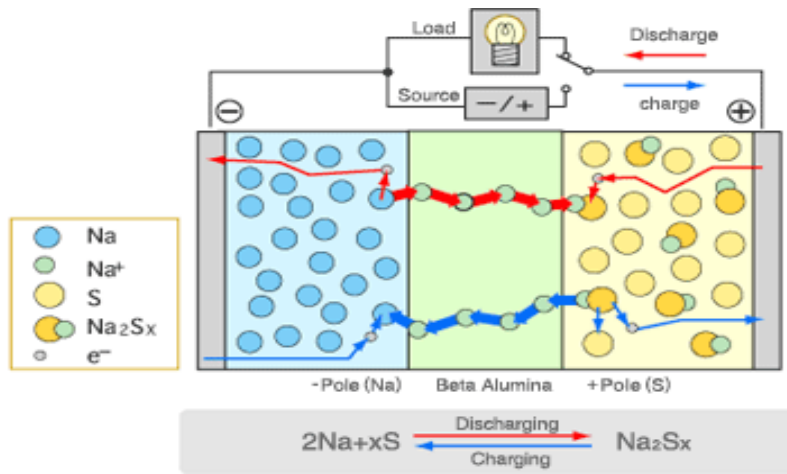

(NGK, 2011)

1.1.5.2 Technology Status

NGK Insulators has commercialized a sodium-beta battery that is at the forefront of grid-scale energy storage. Since 2002, the Japanese company has been manufacturing Na-S battery modules capable of operating at 50 kW for 6 hours. Operators collect these modules into larger MW scale units that vendors market mainly to utilities. As of April 2009, NGK had a total of 300 MW distributed at 200 locations worldwide (NGK, 2011). The main applications for these units are load leveling, power quality maintenance, and renewable energy management. The largest application of NGK's sodium-beta batteries is a 34 MW installation coupled to a 51 MW wind farm built by the Japanese Wind Development Company. NGK also has a partnership with Younicos, a German company that has established a grid-scale energy experiment on the Azorean Island of Graciosa. The goal of this experiment is to power the island's isolated electricity grid with 70-90percent wind and solar energy using 10-30 MW backup generators and a 1 MW NGK Na-S battery system (Younicos, 2009).

NGK is facing growing competition from General Electric (GE), which in 2007 acquired Beta R and D and in 2010 began marketing sodium-beta batteries based on Na-metal halide technology under the trade name Durathon. Durathon designed the modules to be smaller than NGK's and to have the capability for 8 kW discharge for 2 hours (GE). GE is targeting slightly different markets, including backup power supply for hospitals, data centers and wireless communication towers. In these areas, they compete more directly with lead-acid technology. Nonetheless, GE's modules are capable of grid-scale storage, and GE will likely make a stronger push into that market as demand grows. The competition between NGK and GE technologies, with their varying chemistries and module designs, should help increase performance and drive down costs in the near term.

1.1.5.3 Technology Limitations and Opportunities

One of the principal limitations of sodium-beta batteries is their high temperature of operation. As indicated above, both electrodes must be in the liquid state to be sufficiently fluid, to conduct sodium ions effectively, and to ensure that the electrolyte is very conductive, thus minimizing ohmic losses. Freeze/thaw cycles dramatically reduce the working life of sodium batteries, so operators require thermal management systems which, however, can increase the size of sodium-beta batteries and potentially decrease their overall efficiency. An improved sodium-beta battery would have lower melting point electrodes and a solid electrolyte that is sufficiently conductive at low temperatures, which would reduce thermal losses, improve efficiency, reduce material costs, and improve durability. Sodium-beta batteries also suffer from decreasing liquid volume in the sodium anode during discharge, resulting in reduced contact between the BASE and the liquid sodium, which can reduce efficiency and output. Manufacturers can improve this interaction by using a variety of methods, including gravity, wicking, or gas pressure. Wicking is the most practical method, and manufacturers predominately use this method in commercial sodium-beta batteries (Yang, 2010). Surface treatment and surface science studies of the BASE could enhance understanding of the electrode-electrolyte interface (Nexight Group, 2010a, p. 25).

The molten polysulfide cathode in the Na-S battery is extremely corrosive and tends to degrade the BASE. If the BASE fails, the liquid cathode and anode will penetrate the cracks and, upon contact, react violently. The semi-solid cathode in the Na-metal halide battery has a much safer mode of cell failure that results in low resistance so that other Na-metal halide cells in series can continue to function. Developers of Na-metal halide batteries also have the potential to improve the battery performance by using alternative transition metal chlorides, which can lower operating temperatures, improve safety and increase reliability. Future research should address corrosive interactions between the electrodes and electrolytes. Less corrosive electrodes would justify thinner electrolytes, which would help lower the manufacturing costs of sodium-beta batteries.

Manufacturers could lower costs in the near term by improving BASE manufacturing techniques, which include materials preparation by sol-gel chemistry, co-precipitation, or spray-freeze/freezing drying. The purity of the sodium beta-alumina is important because the presence of different alumina phases or impurities like calcium or silicon can reduce the membrane's conductivity significantly. Currently, sodium beta-alumina membranes are composed of tubes with a wall thickness of 1-2 mm, which is necessary for structural stability (Nexight Group, 2010a, p. 25). Researchers have shown that smaller and more mono-disperse grain sizes lead to better structural performance, which could allow engineers to build sodium-beta batteries with thinner and less expensive membranes (Yang, 2010).

1.1.6 Metal Air Batteries

1.1.6.1 Description of Technology

Metal-air batteries get their name from reactants that provide energy by undergoing electrochemical reactions. In zinc-air cells, for example, energy is released by oxidizing zinc (which is held within the battery case) with oxygen from the air. Insofar as the oxidizer is not stored in the battery but supplied continuously from an external source—air—these kinds of batteries are similar to fuel cells, in which neither the oxidizer nor the fuel is packaged inside the cell. Metal-air batteries reduce atmospheric oxygen to form oxides and/or peroxides with various metals. Metal oxidation reactions have high energy density, and because the batteries use atmospheric oxygen as the active cathode material, the weight of the cathode reactant is not included in the weight of a metal-air battery. These two factors combine to give metal-air batteries high theoretical energy densities such as 1,300, 8,100 and 11,100 Wh/kg for zinc, aluminum and lithium, respectively (Armand, 2008; Douche, 1997). Because current Li-ion batteries generate 120 Wh/kg from a theoretical energy density of just 450 Wh/kg, investors have shown significant interest in metal-air batteries.

Engineers use primary Zn-air batteries to power everyday items like watches and hearing aids, and some scientists have proposed using refillable Zn-air fuel cells for automotive applications. However, grid storage applications require flexibility in charging and discharging, which necessitates the use of secondary (rechargeable) batteries. Building secondary metal-air batteries entails a number of technical challenges, and each of the metals proposed for metal-air applications has its own unique properties. For example, Li reacts violently with water while Al develops a thin oxide layer when exposed to air that could interfere with battery operation. The general structure of a lithium-air battery is shown in Figure 4.

Figure 4: Structure of Li-air Battery

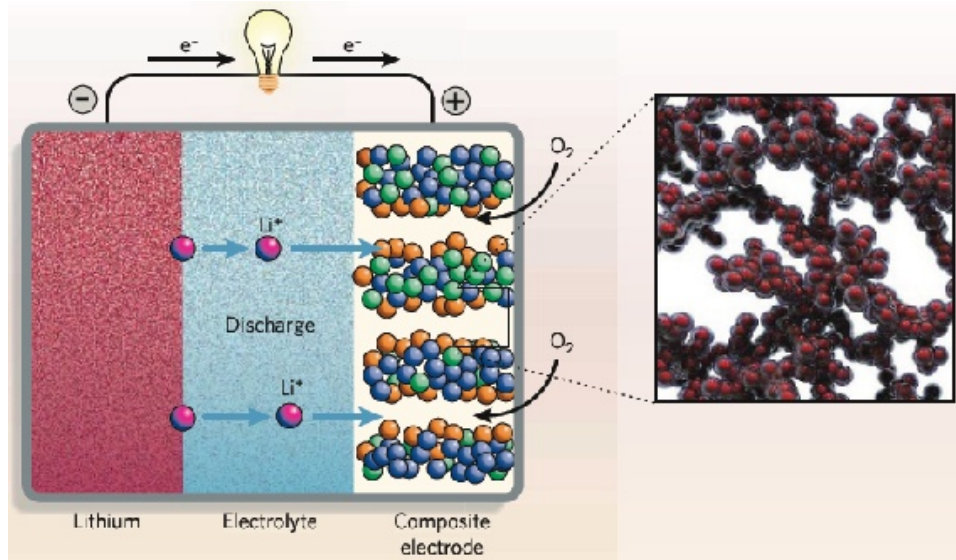

(Armand, 2008)

In this cell design, engineers separate the solid Li metal from a porous carbon composite air electrode with a polymer gel electrolyte. Li ions migrate to the air electrode and react with O_2 to form Li_2O_2 . This reaction has a specific capacity of 1,200 mAh/g and has the unique advantage of reacting without O_2 cleavage to atomic oxygen (O atoms), which has extremely high activation energy and requires expensive catalysts like platinum to reduce activation energy of chemical reactions (Armand, 2008).

1.1.6.2 Technology Status

Scientists developed commercial Zn-air batteries as early as 1932 for applications like remote communication and ocean buoys. In the 1970s, fuel cell research into air electrodes enabled development of the now ubiquitous Zn-air button cell. Zn-air fuel cells with mechanical recharging have been used to power buses and for stationary power generation. The general structures of these fuel cells are a thin air cathode composed of a nonprecious metal catalyst over a carbon current collector, polymer membrane separator, alkali electrolyte and powdered zinc anode. The oxygen reduction catalysts used in the cathodes of these fuel cells are typically composed of manganese oxides made by using sol-gel chemistry (Neburchilov et al, 2010). However, catalysts for secondary metal-air batteries must be able to both reduce and evolve oxygen. Currently, Arizona-based Fluidic Energy is developing zinc-air batteries with an ionic liquid electrolyte for utility-scale applications. The company's choice of catalyst remains proprietary (Yang).

Manufacturers have been unable to develop other metal-air batteries as efficiently as Zn-air. Al-air batteries have a high energy density, but their prohibitive cost, limited shelf life, and

unreliability have thus far prevented them from making much headway in the commercial market (Woodbank, 2011). Currently, the military has been the primary consumer of Al-air batteries for various applications. In 1996, Abraham developed the first lab-scale Li-air battery, and manufacturers built Li-air battery with demonstrable rechargeability ten years later (Abraham, 2006; Armand, 2008). To date, manufacturers have not developed Li-air batteries for the commercial market, and rechargeable Li-air batteries are unlikely to be available in the near term.

1.1.6.3 Technology Limitations and Opportunities

There are numerous challenges preventing the effective implementation of rechargeable metal-air batteries. While using atmospheric oxygen is advantageous from an energy density perspective, it presents many practical difficulties in building devices. To support higher discharge rates, manufacturers need to increase the transport of oxygen to the cathode and develop new catalysts with low oxygen overpotentials (Nexight Group, 2010a, p. 38). Many possible materials deserve further investigation, such as perovskite, pyrochlore, and spinel-type metal oxides (Fujiwara). Another common research problem for all air-metal battery systems is how to reversibly plate the metal during charging. When metals do not plate evenly, they form dendrites that, if they grow long enough, could lead to short circuits and result in exothermic reactions. A classic strategy for smoothing deposited metal surfaces in electroplating is to use chelating ligands, or connecting molecules. However, researchers have not yet applied this method to Li-air batteries (Armand, 2008). In the case of Li-air batteries, catalysts are often composed of a mixture of metal oxides, conductive binders, and porous carbon materials such as aerogels or nanotubes. Li_2O_2 has a tendency to clog the air-catalyst pores. Researchers will need a better understanding of reaction kinetics, as well as finer control over the morphology of the air-electrode, to prevent this clogging. In addition, because Li is highly reactive, manufacturers must take care to prevent the diffusion of water and CO_2 through the air-electrode and electrolyte and into the bulk Li. The use of ionic liquids and anion exchange membranes represents a promising approach for accomplishing this objective.

1.1.7 Electric Double Layer Capacitors

1.1.7.1 Description of Technology

An electric double-layer capacitor (EDLC), also known as supercapacitor, supercondenser, pseudocapacitor, electrochemical double layer capacitor, or ultracapacitor, is an electrochemical capacitor with relatively high energy density. Compared to conventional electrolytic capacitors, the energy density is typically on the order of hundreds of times greater. Conventional capacitors store energy by the removal of charge carriers, typically electrons, from one metal plate and depositing them on another. This charge separation creates a potential between the two plates, which an external circuit can harness. The total energy stored in this fashion increases with both the amount of charge stored and the potential between the plates. The

amount of charge stored per unit voltage is essentially a function of the size, the distance, and the material properties of the plates and the material in between the plates (the dielectric), while the potential between the plates is limited by breakdown of the dielectric. The dielectric controls the capacitor's voltage. Optimizing the material leads to higher energy density for a given size of capacitor.

EDLCs do not have a conventional dielectric. Rather than two separate plates separated by an intervening substance, these capacitors use "plates" that are in fact two layers of the same substrate, and their electrical properties, the so-called "electrical double layer", result in the effective separation of charge despite the vanishingly thin (on the order of nanometers) physical separation of the layers. The lack of need for a bulky layer of dielectric permits the packing of plates with much larger surface area into a given size, resulting in high capacitances in practical-sized packages. EDLCs are applicable for power applications that require very fast response times, high cycleability and less energy density than batteries. The amount of energy stored by a capacitor is proportional to the active surface area of the electrode material and to the square of the voltage under which the charge is stored. Manufacturers make traditional EDLCs by placing an aqueous electrolyte like potassium hydroxide (KOH) or sulfuric acid (H₂SO₄) between two carbon-based electrodes, usually activated carbon. The aqueous electrode has a limited voltage window because water will break down via hydrolysis at just over 1 V. Also, activated carbon is not optimized for charge storage and has regions of nanodimensional pores which are inaccessible to the electrolyte and thus electrochemically inactive. EDLCs possess an enormous advantage over other technologies due to their extended lifetime of up to a million cycles – a benchmark unmatched by other forms of EES.

1.1.7.2 Technology Status

NEC first commercialized the aqueous electrolyte supercapacitor in 1971 and used the technology as backup power for computer memory. In 2011, commercial EDLCs use organic electrolytes like acetonitrile that have lower conductivity but have a maximum useful voltage, or breakdown voltages, as high as 2.7 V. These features dramatically increase the energy density of the devices because of the V² dependence of energy density on voltage. As of 2008, EDLCs were available with energy densities around 5 Wh/kg and peak power densities up to 10 kW/kg (Simon and Gogotsi, 2008). As the performance of EDLCs improves, consumers are using them for an increasingly diverse array of applications. Customers can harness EDLCs as standalone energy storage for short-term back up power supply, regenerative braking in electric and hybrid electric vehicles, and load leveling. They can also couple the devices to other energy sources, including batteries and fuel cells, to increase the power density of those devices. As an energy storage device, however, EDLC's are relatively expensive, with costs in the \$10,000/kWh range.

1.1.7.3 Technology Limitations and Opportunities

Control of electrode pore size is a major area of research for EDLCs. Research suggests that the optimum pore size is just slightly smaller than the mobile ion size. In this case, the pore walls strain the solvation shell that surrounds the mobile ion, increasing the energy stored by the ion (Largeot et al, 2008). Researchers must also consider the distribution of pore sizes in the carbon electrodes, because the balance between large and small pores determines the balance between specific capacitance and resistivity. While small pores store charge efficiently, larger pores are necessary for ions to migrate quickly toward and away from the electrode surface. For EDLCs to maintain sub-second response times with improved energy density, manufacturers must make electrodes with a carefully controlled structure that provides tiny pores for energy density connected by a network of large channels for fast ion conduction.

Improved EDLC designs will take advantage of new nanostructured materials such as nanotubes, aerogels, xerogels, and carbide derived carbons. In addition, new EDLCs feature exotic organic or ionic liquid electrolytes with higher breakdown voltages. Engineers can immobilize liquid electrolytes in solid nanostructures and use them as thin film electrolytes that dramatically increase the power and energy density of the device. Because of the relationship between ion size and optimum pore size, manufacturers must develop electrode materials in tandem with new electrolytes so that new EDLCs can maximize energy density through both increased active surface area and higher voltage windows.

1.1.8 Pseudocapacitors

1.1.8.1 Description of Technology

Pseudocapacitors represent a class of capacitive storage materials that use fast and reversible surface, or near surface, redox reactions to achieve charge storage. The redox reactions result from the adsorption of small ions, typically Li^+ or H^+ , onto the surface of the electrodes. Manufacturers use two classes of materials, conducting polymers and transition metal oxides (TMOs), in pseudocapacitor electrodes.

1.1.8.2 Technology Status

Pseudocapacitors have yet to match the low cost and reliability of EDLCs. Therefore, EDLC charge storage remains the lone commercial technology for capacitor applications.

1.1.8.3 Technology Limitations and Opportunities

The electric charge transfer, or Faradaic, reactions in conducting polymers occur by reversibly doping and undoping the polymer. Doping intentionally introduces impurities into an extremely pure semiconductor for the purpose of modulating its electrical properties. The first conducting polymers only had the potential for p-doping, but developers eventually introduced n-doping polymers. Researchers have only shown polythiophenes to be n-dopable at voltages that are compatible with electrolyte and polymer stability. Recently, manufacturers showed that

n-doped and p-doped polymers could be paired in a device to expand the operating voltage window. Manufacturers have opportunities to further improve this design by designing new conducting polymers that can undergo additional charge transfer reactions (Huggins, 2010, p. 70).

TMOs exhibit very large specific capacitance with only modest surface area. Because of charge transfer reactions, the area-normalized specific capacitance for TMOs is over 100 microfarads per square centimeter ($\mu\text{F}/\text{cm}^2$). In contrast, EDLCs are on the order of $10 \mu\text{F}/\text{cm}^2$. By far, the most significant TMO is ruthenium oxide (RuO_2), which has a specific capacitance of 380 Farads per gram (F/g) when anhydrous, or not hydrated with water. Interestingly, the capacitance doubles to 768 F/g for the hydrated material. RuO_2 has three distinct oxidation states within a 1.2 V window, which is an important contributor to its large capacitance (Simon and Gogotsi, 2008). While RuO_2 is a very potent pseudocapacitive material, the technology is also expensive. For this reason, manufacturers are attempting to reduce the RuO_2 content in electrode materials while maintaining high specific capacitance. One strategy is to make binary Ru-metal oxides with a second, cheaper metal oxide. Promising prototypes with this design have been made with 5 Wh/kg and 750 W/kg (Huggins, p. 77). Another strategy for reducing Ru-content is to embed RuO_2 particles into a traditional EDLC carbon electrode. Coupling RuO_2 with carbon can improve the capacitance of the electrode at higher scan rates when the RuO_2 faradic reaction does not have time to occur. Engineers must develop pseudocapacitive oxide materials that do not contain ruthenium. However, to identify and evaluate new materials, researchers must better understand the kinetics of pseudocapacitance. Potential substitutes for RuO_2 which have attracted investor attention include manganese dioxide (MnO_2), iron oxide (Fe_3O_4), niobium pentoxide (Nb_2O_5), and lithium titanate spinel oxide ($\text{Li}_4\text{Ti}_5\text{O}_{12}$). If manufacturers are to successfully develop pseudo capacitive devices, they must not only achieve higher energy density but also maintain the power density and cycleability that have enabled EDLC-based technology.

1.1.9 Hybrid Capacitors

The strategy of coupling EDLC electrode materials with pseudocapacitive materials into either the same electrode or the same device is a promising way to make new devices that bridge the gap between capacitors, and their fast response, high power capabilities, and batteries and their energy storage capabilities. Manufacturers can make hybrid electrodes by coating carbon nanotubes with conducting polymers. This design resulted in electrodes with 170 F/g capacitance in aqueous electrolytes, compared to just 80 F/g for a typical carbon nanotubes electrode. Manufacturers can make hybrid devices by coupling carbon negative electrodes with pseudocapacitive transition metal oxides (TMO) or conducting polymer positive electrodes. In this design, the ratio of the weights of positive and negative active material on the two

electrodes becomes an important device parameter. Researchers also have opportunities for hybridization of capacitors with even mature battery technologies. The lead-carbon battery is a hybridization of traditional lead-acid technology with carbon capacitors, and large-scale demonstration projects are in progress for the stationary power regulation market (Huggins, 2010, p. 247). Typically, hybridization results in increased energy density with decreased cycleability, so manufacturers must understand the application requirements when deciding whether a hybrid device is desirable.

1.2 Mechanical Energy Storage

1.2.1 Pumped Hydro

1.2.1.1 Description of Technology

Conventional pumped hydro uses two water reservoirs, separated vertically. During off peak hours, operators pump water from the lower reservoir to the upper reservoir. When required, the operators reverse the water flow to generate electricity. Some hydro plants have large reservoirs resulting in storage capability, and operators can dispatch them in a similar manner as a pumped hydro – meaning they can stop and start the units depending on grid needs, while retaining the water in the large reservoir to support rapid ramping and regulation.

Underground pumped storage, using flooded mine shafts or other cavities, is also technically possible. Industry representatives are currently investigating these options. Pumped storage developers have also used the open ocean as the lower reservoir. Engineers in Japan first built the 30 MW seawater pumped hydro plant in 1999 (Yanbaru Project).

Figure 5: Cutaway Diagram of a Typical Pumped Hydro Plant

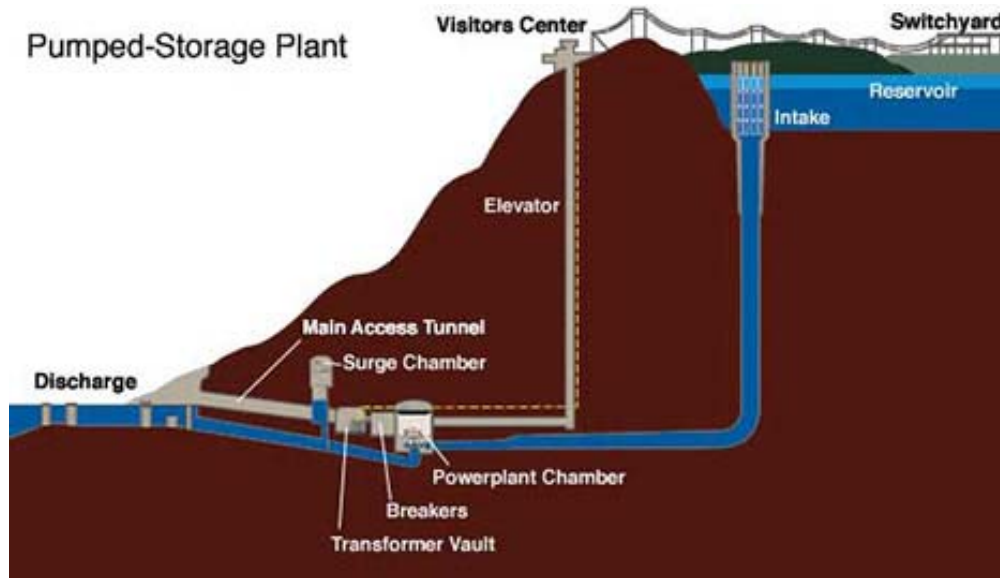

(MacKay, 2007)

Taking into account evaporation losses from the exposed water surface and electrical conversion losses, operators can regain approximately 70percent to 85percent of the electrical energy used to pump the water into the elevated reservoir (ESA, EPRI, 2010a, p. 4-2). The technique is currently the most cost-effective means of storing large amounts of electrical energy on an operating basis, but it entails significant capital costs due to the size of the projects. The presence of appropriate geography is also a critical factor. Pumped storage, however, is cost competitive with other technologies when looked at on a \$/kW and \$/kWh perspective.

The relatively low energy density of pumped storage systems requires either a very large body of water or a large variation in height. For example, 1,000 kilograms of water (1 cubic meter) at the top of a 100 meter tower has a potential energy of about 0.272 kWh. Pumped storage has the ability to store a significant amount of energy by having a body of water located on a hill relatively near – but as high as possible above – a second body of water. In some places this layout occurs naturally, but in other locales, engineers have had to create one or both bodies of water. Analysts refer to projects in which both reservoirs are artificial and in which no natural waterways are involved as "closed loop" and have much less environmental impact. Developers are currently investigating over sixty sites as closed loop pumped storage around the country, with the potential for over 50 GWs of energy storage.

This system may be economical from a regional perspective because it flattens out load variations on the power grid. As a result, pumped hydro allows thermal power stations (such

as coal-fired plants and nuclear power plants) and renewable energy power plants that provide base-load electricity (base load power plants) to continue operating at peak efficiency, while reducing the need for "peaking" power plants that use costly fuels. However, capital costs for purpose-built hydro-storage are relatively high and may require the construction of new transmission lines.

Over 129 GW of pumped storage are in operation worldwide, totaling approximately 3percent of global generation capacity. Pumped storage is the most widespread energy storage system in use on power networks. Its main applications are for energy management, energy imbalance, frequency control, and provision of system reserves. Italy and Switzerland first developed pumped hydro in the 1890's. By 1933, engineers had made reversible pump-turbines with motor-generators available. Operators are now using adjustable speed machines to improve the operating range of the units and, more importantly, provide fast response for frequency regulation. Pumped hydro is available at almost any scale with discharge times ranging from several hours to a few days.

1.2.1.2 Technology Status

Pumped hydroelectric energy storage is a large, mature, and commercial utility-scale technology currently that utilities use at many locations in the United States and around the world. This application has the highest capacity of the energy storage technologies that experts have assessed.

Developers may size these projects up to 4,000 MW. Pumped hydro plants have very long lives (typically 50 years or so) and fast response times enable them to participate equally well in applications, including:

- Voltage and frequency regulation - Balancing supply and demand by providing ancillary services to the grid.
- Spinning reserve and non-spinning reserves markets - Generation capacity that is on-line but unloaded and that can respond within 10 minutes to compensate for generation or transmission outages. "Frequency-responsive" spinning reserve responds within 10 seconds to maintain system frequency. Spinning reserves are the first type used when shortfalls occur.
- Energy arbitrage – Storing energy when electricity is abundant/cheap, and discharging into the grid when electricity is more valuable.
- System capacity support – Providing additional energy resources to supplement generation capacity.

While the siting, permitting, and associated environmental review processes can take many years, investors and advocates have exhibited a growing interest in re-examining the

opportunities for pumped hydro in the United States, particularly with the large amounts of wind and new nuclear power generation that various states may deploy over the next few decades. As can be seen in Figure 6 below, the number of FERC preliminary permits under development are significant and are primarily in the western interconnect. Analysts consider most of these sites as closed loop systems with no new dams on main stem rivers, which may ease the regulatory process and mitigate environmental concerns. Also, developers of many of these projects are exploring adjustable speed technologies which provide greater frequency regulation and reserves capability.

Figure 6: Proposed Pumped Storage Projects in the United States

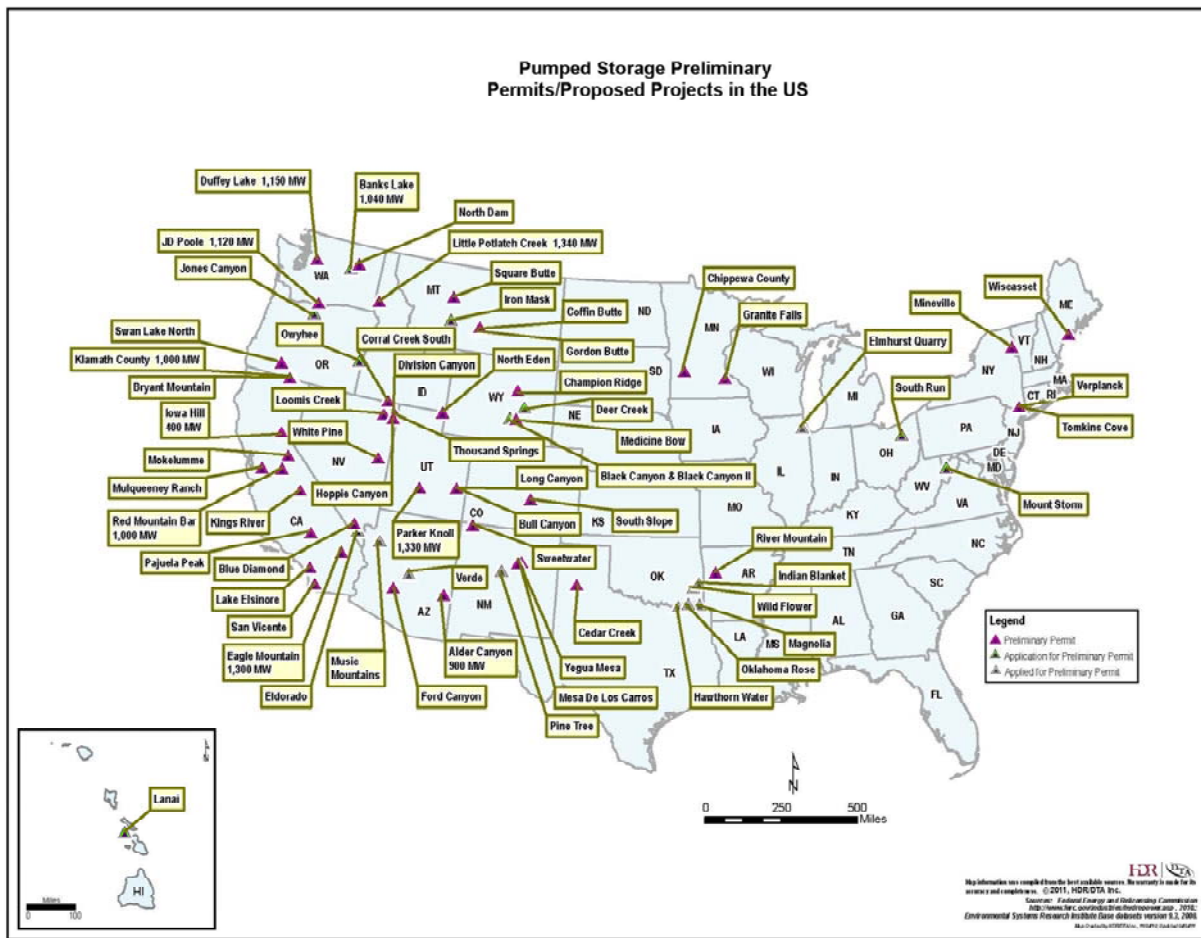

(HDR/DTA, 2011)

In 2011, EPRI began undertaking research to better estimate the future costs of building new pumped hydro facilities.

1.2.1.3 Technology Limitations and Opportunities

Pumped storage plants generally entail long construction times and high capital expenditure. To expand the availability of sites, developers have investigated the use of underground

reservoirs and proposed several new underground pumped storage projects. Recent examples include the proposed Summit project in Norton, Ohio and the Mount Hope project in New Jersey, which would have used a former iron mine as the lower reservoir. Although cost estimates for these projects are higher than for surface projects, their use might greatly expand the number of pumped storage sites. Eagle Crest Energy Company proposed to develop the Eagle Mountain Pumped Storage Project (Eagle Mountain) located near the towns of Eagle Mountain and Desert Center in Riverside County, which could nominally provide up to 1,300 MW of generating capacity. The upper and lower reservoirs would be formed from existing mining pits. In addition, Riverbank Power, which merged with Symbiotics LLC in December 2010, developed a number of Closed Loop Pumped Storage Projects (CLPS) throughout the United States. The Parker Knoll CLPS (FERC project 13239) would provide flywheel-type regulation services for up to 500 MW using state-of-the-art, variable speed pump generating units.

In addition to CLPS projects, whereby Riverbank builds both the upper and lower reservoir, the company is also actively pursuing underground storage. The company has created an underground pumped storage hydro-electric generation concept called Aquabank. Riverbank's Aquabank technology combines traditional pumped storage hydro-electric power generation with deep mining techniques to generate power. These alternative power generation facilities will use an existing water source to create electricity from turbines located underground. The typical facility will have an installed capacity of 1,000 megawatts, representing enough electricity to power more than 300,000 homes (Riverbank). The Aquabank system temporarily diverts water from a surface source down 600 meter shafts to an underground powerhouse. At the powerhouse, the water turns turbines creating emission-free electric power. A transformer then harnesses this newly generated power and sends it to the power grid to help address periods of peak consumption. Once through the turbines, underground reservoirs temporarily store the water at approximately the same depth as the powerhouse. To complete the cycle, operators empty the reservoirs by pumping the water back to its original source using lower cost power from traditional and renewable power sources. Developers are currently considering two underground projects, one in Wiscasset, Maine, and another in Sparta Township, New Jersey.

Another example of innovating underground storage is a Santa Barbara, California-based startup called Gravity Power, LLC. This company is developing a system called the Gravity Power Module™ (GPM). The heart of the system is a reversible pump-turbine and motor-generator sitting atop an underground "water circuit" consisting of two sealed water-filled vertical shafts – a main bore called the "storage pipe" and a secondary "return pipe" bore. Within the main bore rests a large piston called the "weight stack." The weight stack is the

means of storing energy. Water flows through the two sealed bores at the top and bottom, circulating within the system around the weight stack.

Drawing on grid power, the reversible drive turbine pumps the water down through the return pipe and up the main bore below the weight, lifting the weight to store energy. To release stored energy when power demand exceeds supply, the weight descends, forcing the water up through the return pipe, driving the pump-turbine, and generating electricity in the process. The speed the weight drops determines the power of the GPM, while the length of the storage pipe and the mass of the weight determines the amount of energy stored in a GPM.

Figure 7: Gravity Power Module™

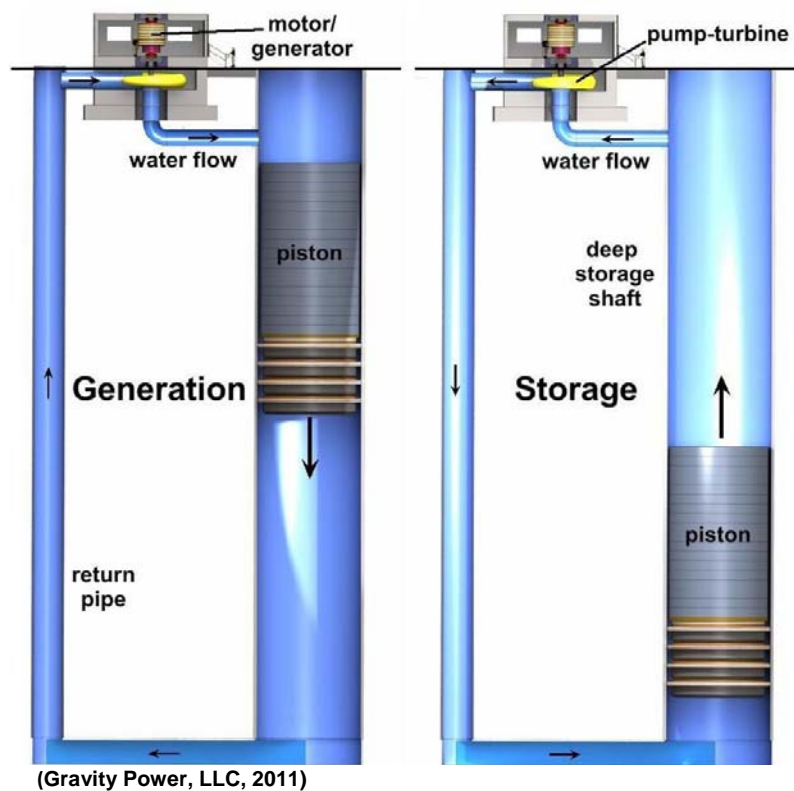

A “peaking” capacity GPM facility will have a drive shaft 10 meters (33 feet) in diameter and 1,000-2,000 meters deep (about 3,200 to over 6,500 feet deep). The company claims that operators can cluster the system together. Eight such shafts could provide up to 150 megawatts each for four hours. Up to sixteen GPMs clustered together could supply a total of 2,400MW on 2.5 acres of land – essentially 1 gigawatt per acre which operators can locate anywhere they can construct a deep hole, independent of the need for an upper and lower reservoir. Gravity Power also claims a ramp speed from zero to full power in about 20 seconds and efficiencies of

75 to 80 percent over a broad power range, from smaller ancillary service applications to full-scale peaking plants.

While the Gravity Power system will provide pumped storage performance with location flexibility at the low end of traditional pumped storage cost, engineers can take advantage of existing abandoned mine shafts that provide an already constructed hole. The technology may also be well-suited to desert environments where emergency water supply has value.

Another new concept involves using wind turbines or solar power to drive water pumps directly, in effect creating an “Energy-Storing Wind or Solar Dam.” This option could provide a more efficient process and smooth out the variability of energy captured from the wind or sun (Buena and Cartab, 2006; Popp).

In addition, engineers can use pumped sea water to store energy. For example, the 30 MW Yanbaru project in Okinawa was the first demonstration of seawater pumped storage. Developers have recently proposed a 300 MW seawater-based project on Lanai, Hawaii and several seawater-based projects in Ireland. Tidal lagoons could present another seawater option. Operators allow seawater to flow into the lagoon at high tide when the water level is roughly equal to either side of the barrier. The potential energy difference is close to zero at this point. Then the operators release the water at low tide when a head of water has been built up behind the barrier and there is a far greater potential energy difference between the two bodies of water. As operators recover the energy used to pump the water, they will have multiplied the energy to a degree depending on the head of water built up behind the barriers. Developers can further enhance the process by pumping more water at high tide with intermittent renewables, thus increasing the head with renewable energy (MacKay, 2007). In addition to potential environmental impacts, downsides of this method include having to locate the generator below sea level and the frequent need to remove the marine organisms that tend to grow on the equipment and disrupt operation.

1.2.2 Compressed Air Energy Storage

1.2.2.1 Description of Technology

Compressed air energy storage (CAES) uses off-peak electricity to compress air and store it in a reservoir, either in an underground cavern or aboveground pipes or tanks. When utilities need electricity, operators heat the compressed air by combustion, thus expanding the air and passing it through a conventional turbine to develop electricity (EPRI, 2010a, p. 4-4).

Figure 8: CAES Plant with Underground Storage

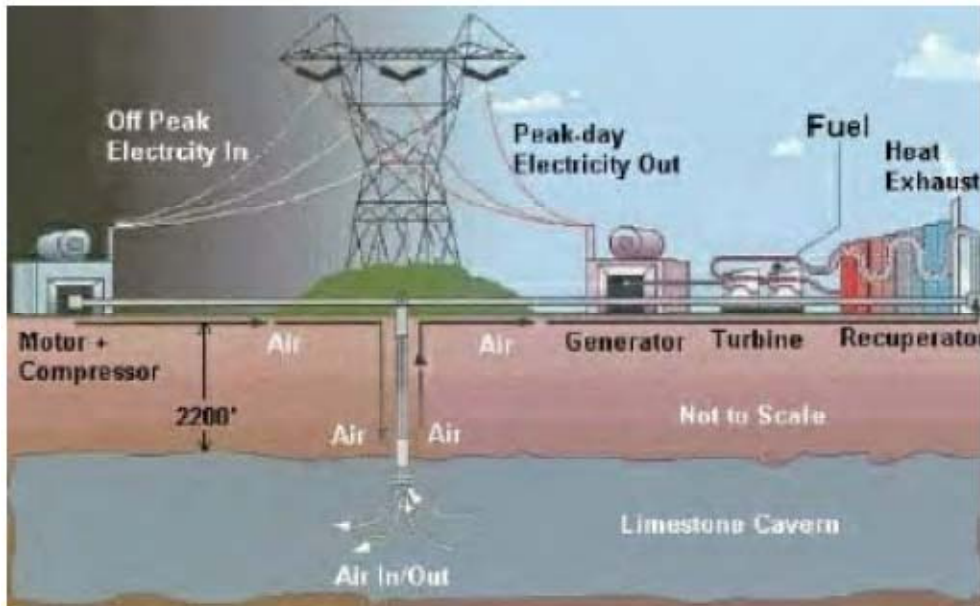

2010a, p. 4-6)

(EPRI,

1.2.2.2 Technology Status

Developers built the world's first CAES plant (290 MW) in Huntorf, Germany and have operated it since 1978. Developers then built a modern 110 MW plant with a storage capacity of 2,700 MWh in McIntosh, Alabama, which has been operational since 1991 (Cavallo, 2007). Currently these two plants are the only CAES plants that are operational in the world. These plants are so-called "first generation" CAES plant because they rely only on the basic CAES structure (see description of technology). They are differentiated from "second generation" CAES, which in concept improves the energy recovery efficiency due to modifications of the structure.

The Huntorf facility has an efficiency of 42percent and the McIntosh facility has an efficiency of 54percent (RWE, 2010). At times, operators have used the Huntorf facility to level the variable power from wind farms (Greenblatt, 2007).

Figure 9: Aerial View of CAES Plant in Huntorf, Germany

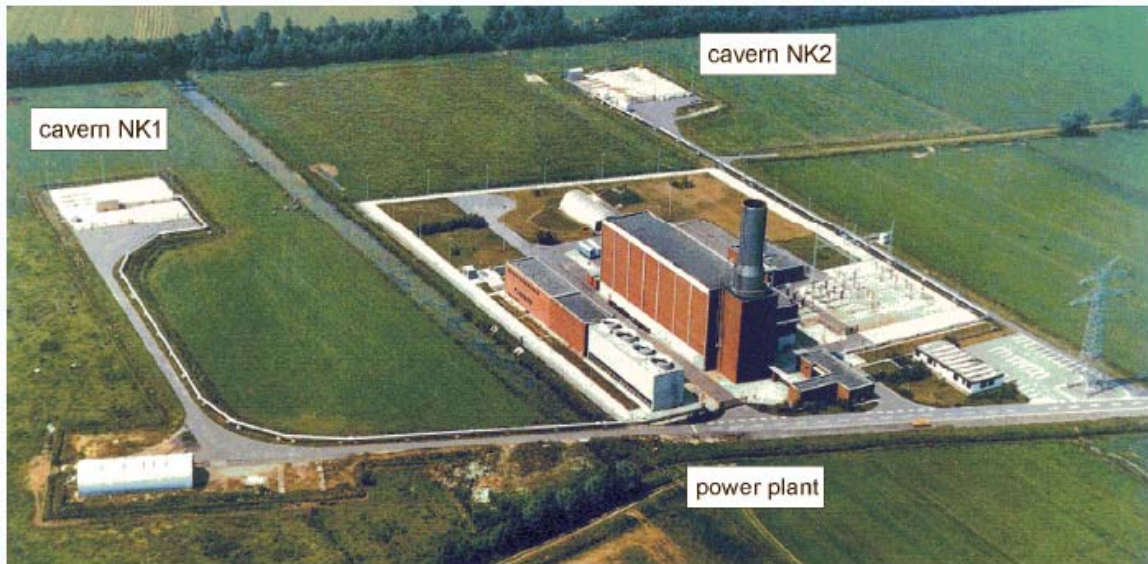

(Photo Credit: Alstom)

Figure 10: Aerial View of CAES Plant in McIntosh, Alabama



(Photo Credit: Energy Storage and Power, LLC)

Other plants are in development, including a 260 MW plant in Iowa and a 2,700 MW plant in Ohio (Greenblatt, 2007). Developers intend the Iowa facility to provide storage for wind energy. A number of researchers have studied the significance of CAES for wind power storage (Swider, 2007; Cavallo, 2007; Bullough, 2004). Other current research on CAES focuses on its limitations and how to address them. The following sections discuss this analysis.

1.2.2.3 Technology Limitations

Current compressed air energy storage (CAES) systems suffer from two primary limitations:

1. Reduced roundtrip efficiency associated with the cooling/reheating process, and
2. CO₂-emissions produced by the reheating process. Air cooling between compression stages, although necessary, represents a loss of heat energy. Direct combustion with natural gas usually performs the air reheating before the expansion turbine, producing CO₂ emissions.

1.2.2.4 R and D Needs and Opportunities

Researchers have focused efforts to improve the current state of CAES by addressing these limitations. They have proposed new or modified CAES systems, with the most notable being the advanced adiabatic (AA) CAES system. Unlike current CAES systems, which use intercooling and aftercooling for heat removal, the AA-CAES system uses a thermal energy storage unit that absorbs heat from the hot compressed air and saves the heat energy for later use to reheat the air before expansion (Bullough, 2004). Theoretically, this process can achieve higher roundtrip efficiency because the thermal energy storage unit stores heat energy that would otherwise be lost by cooling. In addition, because the thermal energy storage unit accomplishes the reheating, the process produces no CO₂-emissions.

Presently, the AA-CAES concept is in a research and development phase. RWE Power, working jointly with General Electric, Zublin, and DLR, are developing an AA-CAES demonstration by 2013 (RWE, 2011). If the demonstration is to be successful, the group must overcome a number of key technical challenges. For example, without the use of intercooling, the air temperature inside the compressor can exceed 650 C. This effect, coupled with the high pressure of compression (up to 100 bar), creates an environment that is too aggressive for modern compressors. Therefore, a primary R and D need for AA-CAES is a high pressure/high temperature compressor design with considerations for material selection, thermal expansion and thermostresses, sealing concepts, and thermal limitations for bearings and lubrication (Finkenrath, 2009).

Figure 11: Conceptual AA-CAES System

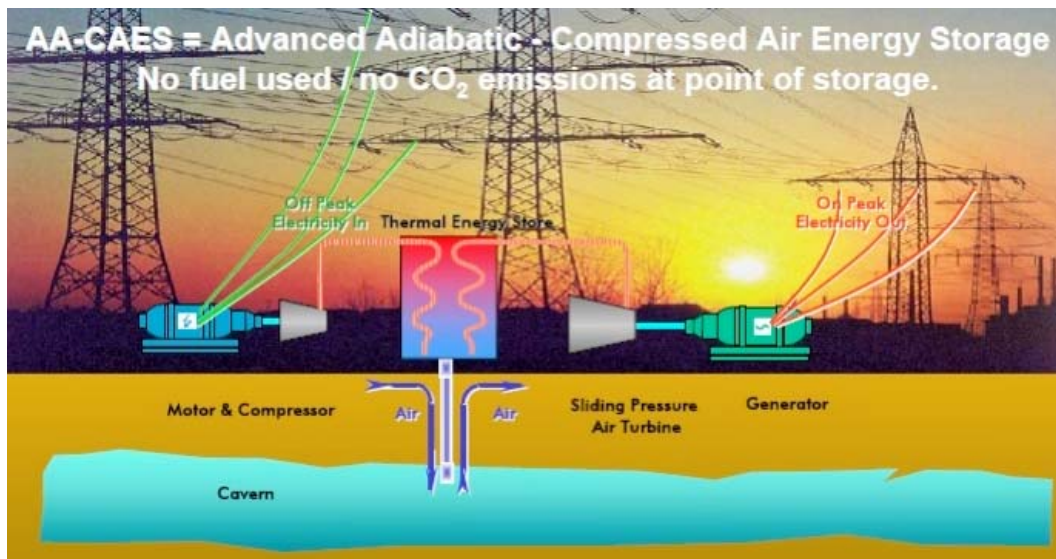

(Alstom Power Ltd., 2011)

Another primary R and D need for AA-CAES is the development of an efficient thermal energy storage (TES) unit. At present, researchers have identified a number of candidate options, but they must undergo further R and D efforts to find the optimum TES system. The main consideration for researchers is whether they should use a liquid or solid media TES. In a liquid TES, the compressed air indirectly transfers heat to a liquid media via a heat exchanger. This setup has the advantage of not requiring a pressurized vessel for the liquid media, but the process adds cost and complexity due to the addition of the heat exchanger equipment. Because the TES must operate over a broad range of temperatures (from 50 to 650 C), researchers must consider suitable forms of liquid media. Engineers have proposed dual media approaches, such as salt and oil. In a solid TES, the compressed air directly contacts and transfers heat to a solid media. A solid TES system has the advantages of large surface area for heat transfer and generally uses inexpensive storage materials. However, it requires a large pressurized container for the solid media and compressed air. For the solid TES, manufacturers must pay special attention to the material selection. Possible materials include natural stone, concrete, fireproof material, and metal. Manufacturers will need to undertake further research and testing to identify additional candidate materials that absorb and release heat quickly. In addition, engineers must design the TES pressurized vessel to be sufficiently durable against gas permeation and leakage and against cyclic stresses caused by high fluctuations in operational temperatures and pressures. In either TES system, engineers must consider similar durability for insulation and pipelines.

Manufacturers will need further R and D to address the challenges presented by underground cavern and turbine technologies used in current CAES plants. For example, the humidity of

underground caverns can corrode the underground bore-hole equipment, the cavern heads, pipes, and fittings (RWE, 2010). In addition, engineers have not designed modern turbines to handle efficiently the high pressure and flow rate fluctuations required of the CAES process. Researchers have proposed a solution using a turbine with adaptive stages, also known as a sliding pressure air turbine.

In addition to the AA-CAES modification, engineers have also proposed so-called 2nd generation CAES cycles (Nathamkin, 2008). These methods retain the cooling/reheating process of conventional CAES but make augmentations elsewhere in the cycle to improve the overall efficiency. Two such 2nd generation CAES augmentations use bottoming cycles with air injection and air chilling. In either case, an auxiliary compressor-turbine cycle, or bottoming cycle, produces hot combustion gas that reheats the stored air via a recuperator heat exchanger. After the recuperator, the stored air expands across a turbine. In the air injection setup, operators inject some air from the turbine exit into the bottoming cycle at the point of combustion. The rest of the air undergoes a second stage expansion across another turbine. In the air chilling setup, the air at the turbine exit is colder, and the bottoming cycle compresses the air before combustion. These 2nd generation CAES concepts have the benefit of only requiring standard turbomachinery technology and can be readily implemented. R and D efforts in this area should focus on a cost/benefit analysis of such systems and development of demonstration systems.

Figure 12: Conceptual 2nd Generation CAES with Air Injection

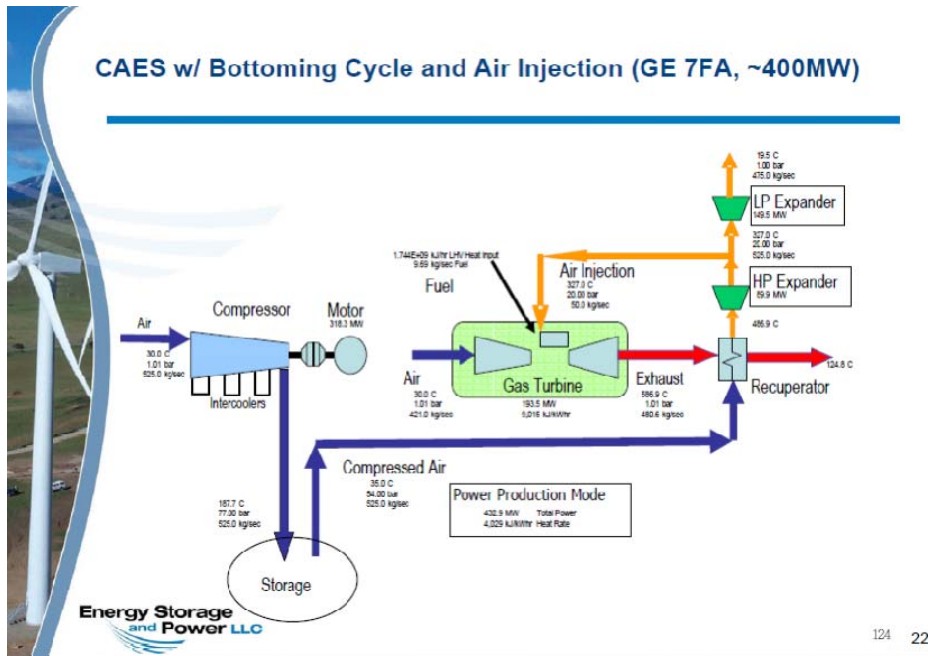

(Energy Storage and Power LLC, 2011)

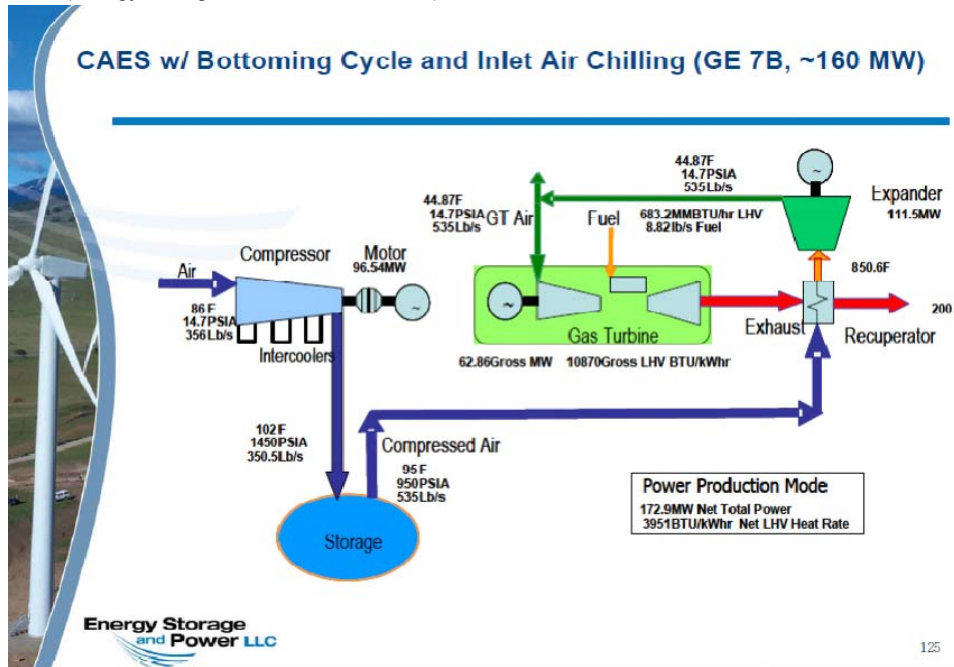

(Energy Storage and Power LLC, 2011)

Yet another CAES modification uses an air saturator to increase the humidity of the stored air. The humid air is injected into a bottoming cycle at the point of combustion. The resulting exhaust gas expands across a turbine.

Figure 13: Schematic of CAES with Bottoming Cycle and Humidification

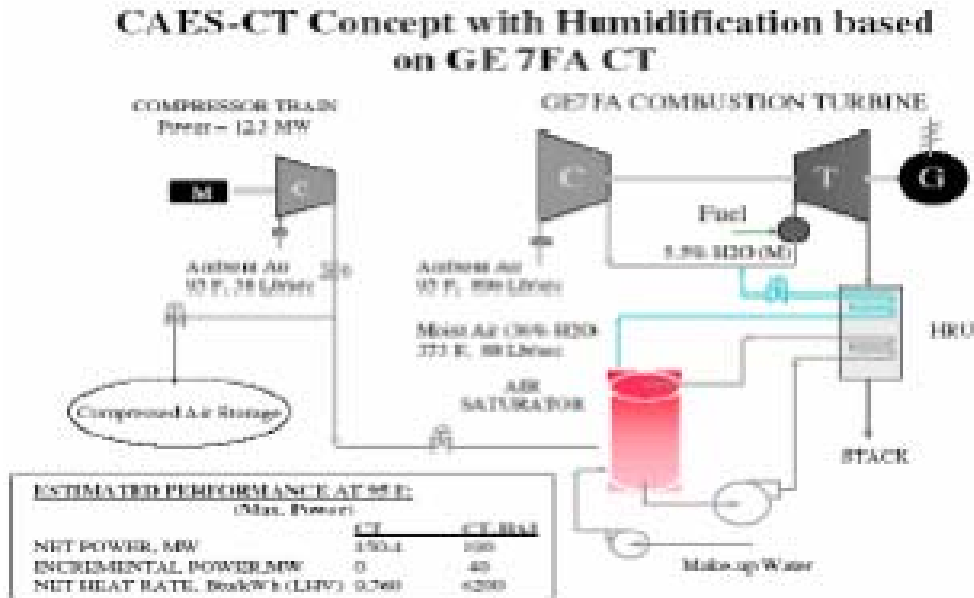

(Pearl Street Inc, 2011)

Up until this point, the discussion has focused on large-scale CAES using underground caverns to store compressed air. However, when underground caverns are not available, engineers should consider aboveground storage using man-made tanks. This type of CAES system, however, is only suitable for small-scale storage. Engineers need to undertake further R and D efforts to compare small-scale CAES with other small-scale storage technologies to determine if and when CAES is a better option, in terms of cost and performance.

In all the aforementioned CAES concepts, operators allow the storage pressure to vary according to the supply and demand of compressed air. Purtz proposes a new CAES concept that calls for the use of an isobaric (constant pressure) storage system (Purtz 2010). Operators maintain constant pressure in the storage tank by submerging the tank underwater in a large lake or ocean and exposing the air to the hydrostatic pressure of the surrounding water. The immediate benefit of a constant pressure air storage device is that the turbine input will also be at a constant pressure. As a result, developers can use currently available turbines instead of specialized turbines to handle variable pressure. They can also combine this concept with AA-CAES. However, these benefits come at the cost of added complexity. Developers must consider material wear and insulation in a high pressure, possibly saline environment, costs and technical challenges associated with the construction of a floating CAES platform with flexible pipeline to the underwater tank, and concerns about the overall environmental impact.

Figure 14: Schematic of AA-CAES with Isobaric Storage

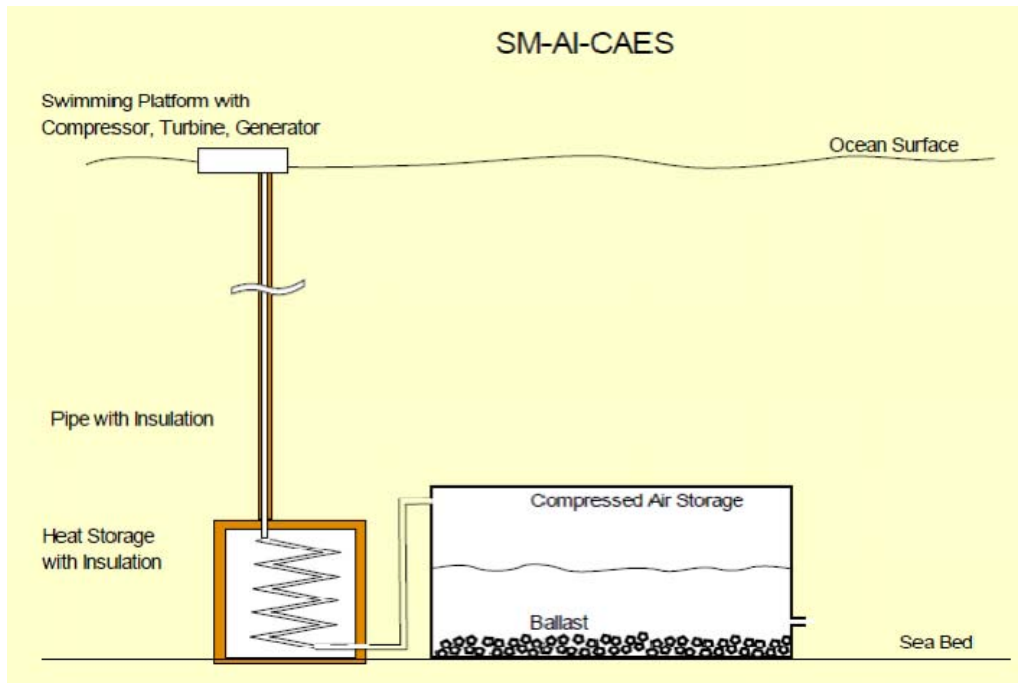

(Jurgen Purtz, 2011)

Developers are pursuing other CAES concepts at a research and development scale, including the concept of Regenerative Air Energy Storage (RAES). In this approach, operators compress and expand air nearly isothermally (that is, at close to a constant temperature). As a result, the technology wastes less energy and creates more energy in the form of compressed air. A promising approach to maintaining near-isothermal conditions in the compression or expansion chamber is to spray a liquid with high heat capacity into the chamber to cool it during operation. If a sufficient quantity of the liquid is present, the great majority of the heat will transfer to the liquid, so that the overall rise in temperature is small. Operators can manage the low-temperature heat in the liquid much more easily than very high-temperature air. They can, for example, use the heat for space heating or store it as warm liquid that can be re-used during expansion.

1.2.3 Flywheels

1.2.3.1 Description of Technology

Flywheel energy storage (FES) works by accelerating a rotor (flywheel) to a very high speed and maintaining the energy in the system as rotational energy. When engineers extract energy from the system, they reduce the flywheel's rotational speed as a consequence of the principle of conservation of energy; adding energy to the system correspondingly results in an increase in

the speed of the flywheel. Most FES systems use electricity to accelerate and decelerate the flywheel, but engineers are developing devices that directly use mechanical energy. Advanced FES systems have rotors made of high strength carbon filaments, suspended by magnetic bearings, and spinning at speeds from 20,000 to over 50,000 rpm in a vacuum enclosure. Such flywheels can come up to speed in a matter of minutes.

Flywheels are mechanical devices that have large amounts of inertia and store energy in the form of rotational motion. The main flywheel components include a rotor, a stator, and bearings. Operators accelerate a cylindrical assembly, often referred to as the rotor, to high speeds from an energy source, such as grid electricity, and store the energy in rotational kinetic form. Operators maintain the energy as long as the flywheel. When the operators need energy, they convert the kinetic energy (back to electricity for example) by slowing the flywheel.

The stator, which is stationary relative to the rotor and is connected to the utility grid through electronics, typically supports the massive rotating cylinders. Excess grid electricity drives a motor that spins the flywheel, transferring and storing the electricity in the form of rotational kinetic energy. Operators then discharge the device by running a generator that feeds back into the grid.

Modern flywheel energy storage (FES) systems rely on magnetically levitated bearings that mitigate wear and tear on bearings, thereby extending the system's life. Operators maintain efficiency by locating the FES in a vacuum-like environment to reduce drag. Developers first used mechanical bearings, but recent advances to improve performance and cost-effectiveness have made high temperature superconductor bearings (HTS) a popular choice for bearing systems to reduce frictional losses and extend energy storage time.

The choice of material for the cylinders depends on the application, and manufacturers must consider the system requirements for cost, weight, size, and performance. One of the primary limits to flywheel design is the tensile strength of the material used for the rotor. Generally speaking, the stronger the disc, the faster operators can spin it and the more energy the system can store. The flywheel will shatter when it exceeds its tensile strength, releasing all of its stored energy at once. Cylinders made of solid and dense steel are limited to a lower tip velocity at the rim (200 to 375 m/s) than those made of lighter and stronger composite materials, which can attain much higher speeds (600 to 1,000 m/s) (ESA).

1.2.3.2 Technology Status

Developers have matured flywheel technology through the advent of strong, lightweight materials, microelectronics, and magnetic bearing systems. Operators have tested the present designs of US Flywheel Systems and showed that power densities at designed speed of 110,000 RPM will exceed 11.9 kW/kg with an in-out efficiency of 93percent (Vit et al, 2004). Beacon

Power is currently developing and demonstrating megawatt-scale flywheel plants with cumulative capacities of 20 MW for frequency regulation applications.

1.2.3.2.1 Maturity and Availability

Researchers have primarily focused on improving the rotor component, which is responsible for sustaining energy through spinning

Aerospace and uninterrupted power supply (UPS) applications have driven the development and purchase of high-powered flywheels. Recent interest from investors has spurred developments for commercial FES. Researchers and suppliers are striving for low-cost and efficient systems that can store energy for longer operation periods on the scale of hours.

FES activities and efforts in the 1990s have shown promise in development and have created the push for larger-scale systems. In 1998, Chubu Electric Power/Mitsubishi Heavy Industry succeeded in developing a 1 kWh FES using an axial-type superconducting magnetic bearing (Nagaya et al, 2003). The US Argonne National Laboratory developed a 2.25 kWh FES using a high temperature superconductor (HTS) bearing (Mulcahy et al, 2011). Boeing is currently developing a 5kWh/50kW FES in collaboration with Argonne (Boeing Phantom Works). And in Germany, the Piller group is attempting to realize a 10 kWh/2MW class FES for uninterrupted power supply (Siems et al, 2004).

Recently, manufacturers have deployed systems for telecommunication applications. Such systems are rated at 2 kWh and 6 kWh. A flywheel farm approach can also attain megawatts for minutes and hours. Beacon Power has successfully developed a flywheel network consisting of forty 25 kWh wheels capable of storing 1 MW for an hour, both efficiently and with a small footprint (Beacon, 2011).

1.2.3.2.2 Performance

Two classes of flywheel rotors exist. Advanced composite materials, such as carbon fiber and graphite, have high strength-to-weight ratios, resulting in high specific energy storage by virtue of the higher rotational speeds thus enabled. The second class relies on steel as the main structural material, resulting in large diameters, slower rotational speeds, and lower power and energy densities [Liu and Jang, 2007].

Material choice is important in determining the energy storage in flywheels. The energy stored is proportional to its mass and the square of its rotational speed, or more accurately its angular velocity. At the same rotational speeds, higher mass flywheels are capable of more energy storage. The tensile strength of the flywheel material limits the maximum specific energy density (normalized by mass). Steel with fiber-reinforced composites typically have the highest





tensile strength. Moreover, experts deem these materials to be safer at higher rotational speeds during failures because the flywheels tend to delaminate and disintegrate gradually from the outer circumference rather than explode catastrophically (Demachi et al, 2002).

1.2.3.2.3 Geometry

Engineers choose the geometry to maximize the energy density, specific energy, or both [Wagner et al, 2002]. In practice, manufacturers achieve these goals either by placing the mass farthest away from the axis of rotation or increasing the material density. The shape of the rotor also influences the energy storage capability. The specific energy depends on the rotor's shape, characterized by a shape factor as shown in Table 2. The shape factor is a measure of the shape efficiency of the rotor in the stress-limited case (Liu and Jang, 2007).

Table 2: Flywheel Shape Factors

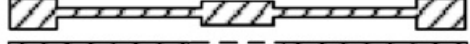
Shape factor for various flywheel geometry

Flywheel geometry	Cross sectional/pictorial view	Shape factor K_s
Flat unpierced disc		0.61
Thin rim		0.50
Rim with web		0.40
Flat pierced disc		0.31

(Liu and Jang, 2007)

1.2.3.2.4 Length

The optimal length is directly related to dynamic considerations (Liu and Jang, 2007). Rotating bodies undergo rigid body and flexural resonance modes, referred to as criticals. When these critical resonances are excited, these modes lead to high losses. If engineers choose bearing systems that are too stiff, these criticals are excited above the operating frequency of the rotor. Engineers must therefore choose bearing systems at the proper stiffness so that the rotating bodies can pass these criticals at low speeds and operate with low damping losses. Engineers choose the length to avoid excitation of the criticals, typically the maximum safe length below the speed of the rotor when it is running at its speed of maximum stress (Liu and Jang, 2007).

1.2.3.2.5 Bearings

Bearings support the spinning rotor. Bearings can be magnetic or can come in the form of balls. Bearings are characterized according to weight, loss, cost, and longevity. Magnetic bearings have the advantage of high spin speeds and good vibration-suppression characteristics. Ball bearings have benefited from advancement in material (ceramics and hardened steel) [Liu and

Jang, 2007]. Lubricant life rather than material fatigue help determine the longevity of the bearings. Keeping operating temperatures low ensures the lubricant does not deteriorate. At higher spin speeds, magnetic bearings are a better choice. However, below a certain speed ball bearings have a weight advantage due to relatively low drag losses. This speed cutoff is application dependent, but it generally falls between 20,000 to 40,000 revolutions per minute (RPM) (Wagner et al, 2002).

In an era when batteries typically have relatively shorter equipment life and higher operational and maintenance expenses, flywheels have become more attractive to electric power companies. In addition, flywheels are better suited for applications experiencing frequent cycling (Federal Technology Alert, DOE/EE-0286).

1.2.3.2.6 Cost

The following cost data are from a DOE report outlining a federal energy management program comparing flywheels and battery storage technologies (Federal Technology Alert DOE/EE-0286). Flywheel purchase costs can range from \$100/kW for larger and/or lower RPM models to \$300/kW for smaller and/or higher RPM models. Installation costs, including electrical connections, are typically simple and inexpensive, ranging from \$20/kW to \$40/kW.

Operating and maintenance costs depend on the flywheel type. Internal staff can handle the routine maintenance, which typically has a minimal and low cost. Vendors offer service contracts for about \$5/kw/year that can be more expensive than internal maintenance. However, these contracts typically include around-the-clock response and extended warranties. Bearing replacements typically range from \$5/kW to \$15/kW, depending on the flywheel design. Manufacturers can replace the vacuum pump at about \$5/kW. Because engineers design flywheels for a long life of about 20 years, these components do not require frequent attention, usually between 5-10 years. Standby power consumption is about \$5/kW/year for lower RPM flywheels using mechanical bearings or a combination of mechanical and magnetic. Higher RPM systems using only magnetic bearings typically cost about \$0.50/kW/year.

1.2.3.3 Technology Limitations

The most significant limitation of flywheels lies in their relatively modest capacity for energy storage (Dell). They are best suited as surge-power devices that experience frequent charge and discharge of modest energy quantities at high-power rates (Dell). The comparatively small amount of electrical energy that they can store limits flywheel applications to locally generated or distributed electricity sources.

The attainable speed affects the deliverable energy back to the grid. At low speeds, flywheels cannot deliver the rated power. For example, over a 3:1 speed range, a flywheel will deliver about 90percent of its stored energy to the electric load (ESA, 2011).

Flywheels are capable of high efficiencies, which offer a significant advantage over other energy storage technologies. However, friction loss in the flywheel rotation is one of the significant limitations of this technology and hinders the potential for FES as a long-term storage option. Analysts have estimated that a 200-ton flywheel can experience up to 200 kW of power loss. Assuming an instantaneous flywheel efficiency of 85percent, the overall efficiency would drop to 78percent after five hours of operation and down to 45percent after one day (Ibrahim).

Currently, FESs using mechanical and/or magnetic bearings can deliver power for only short durations (5 - 30 seconds). The bearings are subjected to parasitic losses such as hysteresis, friction, and eddy current losses, the latter two leading to undesirable temperature rise (Koshizuka, 2002). This temperature increase creates a necessity for cooling systems to prevent component degradation.

In applications where utilities use flywheels as backup power, the fact that flywheels can only perform in durations of seconds limits their use. The backup period is commonly about 15 seconds, which is enough time for backup generators to powerfully and become activated as the primary backup option. Thus, operators should not use flywheels alone for backup power, without batteries and/or fuel-fired generators. Also, operators should not use flywheels without batteries if a fuel-fired generator cannot reliably come up to full power in 10 seconds or less (Federal Technology Alert DOE/EE-0286).

1.2.3.4 R and D Needs and Opportunities

Overall, manufacturers have proven flywheels to be an ideal form of energy storage due to their high efficiency, long cycle life, wide range of operating temperature, freedom from depth-of-discharge effects, and higher power and energy density—on both a mass and volume basis (Kohari et al. 2005; Long et al., 2002; Pieroneck et al., 1997; Ries and Neumueller, 2001).

Flywheels are essentially surge-power devices. They naturally complement battery storage devices and would serve well in these applications. As other applications involving wind turbines and photovoltaic arrays grow in the renewable energy development effort, flywheel-based buffers could help store the large, frequent, and rapid energy fluctuations. This strategy could potentially remove the need for downstream power electronics to track such fluctuations and improve the overall electrical efficiency (Dell). As utilities consider batteries as a storage medium for wind power and photovoltaic array applications, they may also want to evaluate battery-flywheel combinations (Dell).

Unfortunately, FESs still entail high costs and the above-mentioned technology limitations that hinder widespread adoption. The areas for advancement that researchers and industry are targeting over the next decade (Liu and Jang, 2007) include:

- Improved Safety - Research into methods for predicting design and intelligent fault protection can enhance system safety. Development into new software and checkout procedures to address these problems can make a substantial impact on FES management and adoption (Liu and Jang, 2007).
- Increased Specific Power/Energy Density - The kinetic energy stored in a flywheel is proportional to its moment of inertia, a function of its mass and shape. Advances in increasing these two flywheel properties will certainly allow scalability of FES. In addition, the kinetic energy is proportional to the square of flywheel speed. However, the speed limit is set by the tensile strength of the flywheel, which governs the maximal inertial load during operation. Light materials develop lower inertial loads at a given speed. Therefore composite materials, with low density and high tensile strength, are preferred choices for storing energy (Gabrys, 2001). While previous research efforts have designed and tested such materials, current research is ongoing and necessary to develop higher performance flywheel materials and fabricate them at lower cost.
- Improved In-Out Energy Efficiency (Koshizuka, 2002) - Efficiencies of power electronics govern the capability to charge and discharge FES. By increasing the efficiencies of electric power converters, motors, generators, and refrigeration systems, operators can improve the overall FES efficiency.
- Predicted performance and long-term durability in composite flywheels (Tzeng et al, 2006) - Accurate models of rotor behaviors can be useful in determining their long-term operation and assessing the health of the system. Developers can use such models for fault detection purposes and to predict proximity to failure. Manufacturers have employed techniques to model elastic, viscoelastic, and fatigue to predict rotor behaviors (Tzeng et al, 2006). They need test and design procedures to consider the long-term behavior of flywheels, specifically creep, stress relaxation, fatigue, and composite fracture tendencies.
- Superconducting Magnetic Bearings (SMBs) - The discovery of high temperature superconductor (HTS) has spurred research interest and activity into SMBs for their extremely low rotation loss and expected strong levitation forces (Hassenzahl, 2001). Improvements to the homogeneity of the magnetic field distribution in the permanent magnet circuit and the superconducting bulk stator have reduced rotation loss (Koshizuka, et al, 2006). These advances have the benefit of mitigating eddy currents

that lead to inefficiency and material fatigue. SMBs also have the responsibility to produce a sufficient levitation force to support the weight of massive rotors. During operation, rotors may experience gradual fall from decreased levitation forces due to flux creep of the superconducting material (Koshizuka, et al, 2006). Current methods have shown to be effective in handling flux creep. Pre-loading the SMBs and/or excess cooling the bearings below a certain temperature can suppress the fall. SMBs have low stiffness and damping, leading to undesired vibrations and lower efficiencies. Active magnetic bearings (AMBs) have offered a solution at the present, though researchers need additional efforts to reduce their rotation losses and energy consumption (Koshizuka, et al, 2006). In using AMBs, operators will need development in control system design.

- Fabrication Technology (Koshizuka, et al, 2006) - The mechanical strength of the flywheel rotor is critical in high speed rotations. At these speeds, the centrifugal force applied on the outer rotor is strong. Material choice is critical to handle these conditions. The properties of carbon fiber-reinforced plastics are suitable to handle such forces, though manufacturers need further research to identify the optimum conditions for the fabrication process. Such research includes determining the ideal temperatures of the resin and mandrel, winding speed of the fibers, and winding patterns (Koshizuka, et al, 2006). To increase in scale, FES will need to have stiff, stable, and large flywheels. Manufacturers must keep the cost of this fabrication low, especially for HTS bulk materials.
- Improved Overall Efficiency by Reducing Loss (Liu and Jang, 2007) - Increasing voltage decreases current losses and eliminates redundant transformer steps. But isolation problems and limitation in power electronics arise with high voltage. So far, manufacturers have not constructed flywheels over 10 kV for this reason. Recent progress in semiconductor technology offers potential improvements (faster switching, lower costs). Vacuum enclosures represent the best way to eliminate windage loss. Manufacturers will need better heat exchangers in tandem to remove the high heat generated by rotating parts. Engineers can achieve improvements to the radial vibration of rotor axis by using active magnetic bearings. However, the rotation loss in using AMBs is significant and can negate the benefits of using SMBs in the first place. Manufacturers will need further developments to improve the basic structure of FES, including SMB and vibration control technologies (Koshizuka, et al, 2006). According to researchers, if the total loss fraction of FES is reduced to about 0.1percent per hour of operation, the flywheel systems can be effectively used for a variety of applications, including load leveling of power utilities (Koshizuka, et al, 2006).

1.3 Thermal Energy Storage

Gas or electric heating and electrically powered air conditioning currently meet most residential and commercial heating and cooling needs, but use a significant amount of energy that typically comes from less efficient “peaker” power plants. Various technologies can reduce this energy requirement appreciably. For example, better insulation can reduce the heat transfer to and from the environment. Thermal energy storage systems, which large-scale power plants also employ, represent another option. The two general types of thermal storage mechanisms include one based upon the use of the sensible heat in various solid and/or liquid materials and a second involving the latent heat of phase change reactions (Huggins, 2010).

Engineers can add energy to a material by simply heating it to a higher temperature. The energy involved in changing its temperature is called “sensible heat,” and its amount is the product of the specific heat and the temperature change. Technologies can transfer this sensible heat to another, cooler material, or to the environment, by radiation, convection, or conduction. Ultimately, this method stores energy in the form of heat and transfers it later.

Phase change reactions refer to the use of materials with a high heat of fusion that, after melting and solidifying at a certain temperature, are capable of storing and releasing large amounts of energy. The materials absorb or release heat when they change from solid to liquid and vice versa. As a simple example of phase change material with high latent heat, water can go from solid (ice) to liquid (water) to gas (steam).

1.3.1 Solar Thermal

1.3.1.1 *Description of Technology*

The integration of thermal energy storage with solar energy represents a direct grid application for thermal energy storage. Recent and ongoing improvements in solar thermal generation technologies, coupled with the need for more renewable sources of energy, have increased interest in concentrating solar thermal power (CSP). Unlike solar photovoltaic (PV) generation, CSP uses the thermal energy of sunlight to generate electricity. Two common designs of CSP plants - parabolic troughs and power towers - concentrate sunlight onto a heat-transfer fluid (HTF), which the technologies use to drive a steam turbine. One advantage of CSP is the potential for storing solar thermal energy to use during non-solar periods and to dispatch when needed. As a result, thermal energy storage (TES) allows CSP to achieve higher annual capacity factors—from 25percent without thermal storage up to 70percent or more with it (NREL). TES can also provide backup energy during periods with reduced sunlight caused by cloud cover (Sioshansi and Denholm, 2010).

Adding TES provides several additional sources of value to a CSP plant. First, unlike a plant that must sell electricity when solar energy is available, a CSP plant with TES can shift electricity production to periods of highest prices. Second, TES may provide firm capacity to the power system, replacing conventional power plants as opposed to simply supplementing their output. Such capability would, however, require storage capacity sized for extended durations, depending on the system design, and the plant may have to sacrifice revenues when the sun is shining against revenues when it is not. Finally, the dispatchability of a CSP plant with TES can provide high-value ancillary services such as spinning reserves. The storage medium is typically a molten salt, which has extremely high storage efficiencies in demonstration systems.

1.3.1.2 Technology Status

There are hundreds of megawatts of concentrating solar power (CSP) facilities with molten salt energy storage in construction and operation in Spain and in the US, with potentially thousands of megawatts more in development pipelines. Notable domestic examples are Solar Reserve's 110 MW Crescent Dunes and 150 MW Rice Solar Energy projects, and Abengoa's 250 MW Solana project – all three of which were awarded power purchase agreements (PPA) from major United States utilities. Utility-scale CSP facilities have been in operation in California since the late 1970s. In the 1980s and 1990s, the US Department of Energy sponsored the 10 MW Solar One and Solar Two demonstration facilities, establishing the characteristics of a CSP power tower with molten salt storage. This power tower configuration uses sodium and potassium nitrate salts to collect and store thermal energy and then dispatches that energy to a steam turbine whenever grid operators require electricity.

1.3.1.3 Technology Limitations and Opportunities

Researchers have tested a variety of fluids to transport the sun's heat, including water, air, oil, and sodium. To date, molten salt provides the best results. Manufacturers use molten salt in solar power tower systems because 1) it can reach high temperatures at atmospheric pressure without boiling, 2) it provides an efficient, low-cost medium in which to store thermal energy, 3) its operating temperatures are compatible with modern high-pressure and high-temperature steam turbines, and 4) it is non-flammable and nontoxic. In addition, manufacturers use molten salt in the chemical and metals industries as a heat-transport fluid, so experience with molten-salt systems exists in non-solar settings.

The molten salt is typically a mixture of 60 percent sodium nitrate and 40 percent potassium nitrate, commonly called saltpeter. Engineers can include calcium nitrate in the salts mixture to reduce costs and provide technical benefits. The salt melts at 220 °C (430 °F). Operators must keep the salt liquid throughout the life of the plant, moving between a “cold” insulated storage tank at 290 °C (550 °F) and a “hot” tank between 750 and 1050 degrees F (depending upon the

technology). The uniqueness of this solar system lies in the ability to disassociate the collection of solar energy from the production of power. As a result, the technology can generate electricity irrespective of momentary cloud cover or even at night by using the stored thermal energy in the hot salt tank. Normally, manufacturers insulate the tanks thoroughly and, depending upon storage capacity and technology capacity, store the energy for extended periods of several days or more. Tank size and salt inventory depend highly upon operating temperature. Lower temperature designs (in example, troughs) store a fraction of the thermal energy per unit salt.

1.3.2 Thermal Storage for Heating, Ventilation, and Air Conditioning (HVAC)

1.3.2.1 Description of Technology

In a thermal energy storage (TES) system, the device chills a storage medium during periods of low cooling demand and then uses the stored cooling later to meet air-conditioning load or process cooling loads. The system consists of a storage medium in a tank, a packaged chiller or built-up refrigeration system, and inter-connecting piping, pumps, and controls. The storage medium is generally water, ice, or a phase-change material (sometimes called a eutectic salt).

TES systems shift cooling energy use to non-peak times. Analysts generally classify operating strategies as either full storage or partial storage, referring to the amount of cooling load transferred from on-peak to off-peak. TES systems are applicable in most commercial and industrial facilities, but they must meet certain criteria for economic feasibility. A system can be appropriate when maximum cooling load is significantly higher than average load. High demand charges and a significant differential between on-peak and off-peak rates also help make TES systems economical. They may be appropriate when operators need more chiller capacity for an existing system or back-up or redundant cooling capacity.

Besides shifting load, TES systems may reduce energy consumption, depending on site-specific design, such as when operators can use chillers at full load during the night. Also, these systems can reduce pumping and fan energy by lowering the temperature of the water and therefore the air temperature. As a result, they can affect the quantity of air circulation required.

Capital costs tend to be higher than a conventional direct-cooling system, but other economic factors can reduce such costs. In new construction, ductwork can be smaller, allowing more usable space. Or a TES system may enable reduction in electrical capacity, reducing the cost of electrical service for a new or expanding facility.

Load shifting is typically the main reason to install a TES system. Cool storage systems can significantly cut operating costs by cooling with cheaper off-peak energy and reducing or eliminating on-peak demand charges (P G and E).

1.3.2.3 Technology Status

TES is a mature technology that has been available for decades (Schuess, 2009). A number of companies have commercial products available, including but not limited to BAC, Calmac, Evapco, Ice Energy, and Sunwell. An example of TES systems for HVAC is the Ice Energy Ice Bear system, illustrated in Figure 16 TES HVAC Unit with Cooling Coil Integrated into Existing A/C. This technology is a thermal energy storage system targeted for installation on low-rise (fewer than three stories) buildings, which represent over 95percent of the buildings in the U.S. The system consists of four primary parts, an insulated ice storage tank with main heat exchanger, an ice make compressor, a refrigeration management system, and a sophisticated controller. Vendors install the system with the existing (typically) rooftop air conditioning system and leverage the existing blower subsystem. Operators use the condenser subsystem to create the nighttime ice stored in the unit as well as for cooling during daytime operation.

Figure 15: TES HVAC Unit with Cooling Coil Integrated into Existing A/C

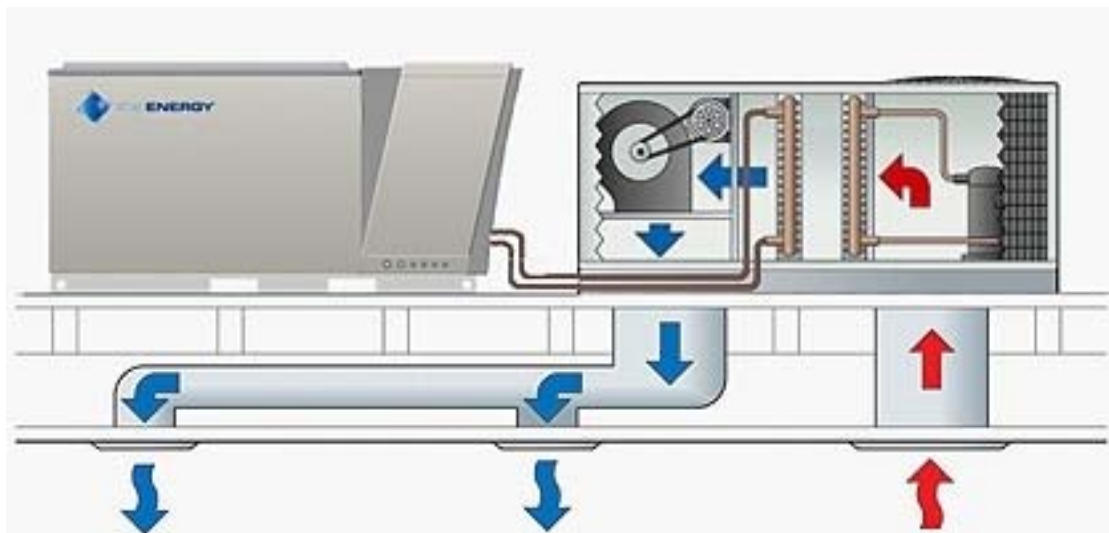

(Ice Bear Energy, 2011)

The key technology elements are the ice coil design, controller, and control interface. Engineers designed the ice coil and refrigerant loop subsystem for maximum energy exchange at all temperatures, using an oil-less liquid overfeed system. Because engineers physically isolate this subsystem from the compressor, the device can independently control the proper oil ratio needed to maintain compressor operation. The refrigerant loop uses an adjustable pump to regulate ice consumption during operation, and the technology limits the power draw to less than 300 watts for the pump. The controller is capable of operating in intercept mode, whereby it receives the signals from the existing thermostat or building control interface. In this configuration, the end user simply sets the temperature, and the controller optimizes the use of the stored ice in conjunction with the existing air conditioning unit. The controller is also capable of more exotic schemes, including one known in the control industry as “PID”

(proportional-integral-derivative) control. Manufacturers have designed the controller interface to work with a well-known time-series data application and to deliver information using typical internet technology and browser interface.

Field tests have shown that these devices can shift up to 95percent of the energy needed for cooling during operation in a single location to the off-peak period, with one installation realizing a 40kW peak reduction. The power needed to run the unit during its cooling cycle is around 300 watts. With time-differentiated rates (time of use, demand charges, critical peak prices), single customer installations can receive a significant benefit from TES installations (extremely short payback periods) (Gunther, 2009).

1.3.2.3 Technology Limitations and Opportunities

Thermal energy storage for commercial HVAC systems is a mature technology approach. The key to maximizing the effective of such systems to shift cooling load and thus support the electric grid is appropriate engineering design and implementation. A number of design options can make TES systems more energy-efficient than non-storage systems. Storage systems let chillers operate at full load all night, versus operating at full or part load during the day (P G and E, 1997).

Depending on the system configuration, the chiller may be smaller than would be required for direct cooling, allowing smaller auxiliaries such as cooling-tower fans, condenser water pumps, or condenser fans. Manufacturers can limit pumping energy by increasing the chilled water temperature range and they can cut fan energy with colder air distribution. Storage systems can also make increased use of heat recovery and waterside economizer strategies (P G and E, 1997).

On the core technology side, few methods of thermal storage could be simpler or more directly usable. These systems create ice during off-peak periods (both electricity demand and ambient temperature) and consume it for cooling during the on-peak period, maximizing round trip thermal energy conversion. The devices lower existing equipment stress through the reduced need for air conditioning compressors to operate during the high-temperature period of the day when cooling demand is greatest. This feature also extends the compressor service lifetime. Likewise, the devices operate the condenser and compressor used to create the ice during the low temperature period of the day, with the same resultant benefit. Furthermore, the system's output does not degrade with temperature. As a result, the maximum capacity of the base system can be "right-sized," with the resulting reduction in compressor capacity (of 10-25percent) producing energy savings even when the machines are not using ice.

An advantage of this particular thermal storage system is the ability to deploy the units either tactically or strategically across the power grid. Utilities can target known problem locations,

feeders, or zones in their system, improving localized system stability and grid conditions. They can also leverage their operational experience and load growth forecasts to defer planned grid enhancements for feeders, substations, and areas. In addition, a large-scale deployment of the units (up to 100's of MW capacity) defers investment in new peak-matching generation or lessens the need to run existing peaking generation. With proper controls and response feedback, grid operators could use this type of energy storage as a virtual spinning reserve, and the devices could bid into demand markets or participate in any number of internal and external load management programs. Even if operators do not use advanced controls, simply running all available units within a territory flattens the daily load curve of the utility and defers both investments to support the demand and the running of any peaking units to serve that demand (Gunther, 2009).

TES systems manufacturers will still need research and investment into a few areas to maximize the value of the technology. The operating states and control algorithms are well known and in fact are already available to be explored through the National Renewable Energy Laboratory (NREL) HOMER tool. As more system designers become familiar with the operation and potential, they can provide user feedback and help improve or even modify the operating states and control algorithms. This feedback might provide improvement over the ongoing monitoring and diagnostics.

1.4 Hydrogen as an Energy Storage System

1.4.1 Description of Technology

Analysts consider hydrogen to be an important energy carrier for the future and, when used as a fuel, as an alternative to fossil fuels, such as coal, crude oil, and natural gas, and their derivatives. Hydrogen has the potential to be a clean, reliable, and affordable energy source and has the major advantage that the primary product of its combustion with oxygen is water rather than CO₂, which is a greenhouse gas. The primary disadvantage of hydrogen is that, although it is the most abundant element, it is predominantly found chemically-bound, such as in water or in hydrocarbons. As a result, the devices must separate the hydrogen from these compounds.

Hydrogen as an energy storage system is a complicated proposition involving three separate processes. First, a device must produce the hydrogen. In a grid energy storage application, the most appropriate production technology is the electrolysis of water using electricity. After electrolysis produces the hydrogen, operators must store it in either gaseous or liquid form. Finally, to return electric power to the grid, operators must convert the stored hydrogen to electricity by either a fuel cell or a combustion gas turbine.

For the application of electricity grid storage, proposed hydrogen systems would comprise an electrolysis unit (otherwise known as an electrolyzer), a compressor and storage system, and, most likely, a fuel cell. Hydrogen electrolyzer/fuel cell energy storage is a storage concept that utilizes off-peak electricity to produce hydrogen from water. The hydrogen serves as an energy carrier that technologies can store as a liquid or a gas that fuel cells can later use to produce electricity. In combination with power electronics, hydrogen electrolyzer/fuel cell systems can provide renewable energy sources with peak shaving, ancillary services, and greater dispatchability. However, hydrogen electrolyzer/fuel cell technology also can provide important services for renewable energy in the damping of power fluctuations. Much like batteries, fuel cells can respond rapidly to power fluctuations from wind turbines. Analysts expect hydrogen to play a significant role in future energy systems. Developers can use it in fuel cells to produce electricity directly, with water as the only product. Researchers have shown that they can use hydrogen directly in internal combustion engines, requiring relatively minor modifications, as well as in gas turbines. The energy efficiency of fuel cells ranges from 40-60percent, depending on the fuel cell technology. Fossil fuel combustion-based systems, on the other hand, are typically less than 40percent efficient, although combined cycle gas turbine systems can achieve up to 60percent efficiency. When manufacturers use high temperature fuel cells, they can generate both electricity and useful heat for heating purposes. This cogeneration makes it possible to achieve total energy efficiencies of up to 80percent in this manner.

Figure 16: Hydrogen Electrolyzer/Fuel Cell Energy Storage System.

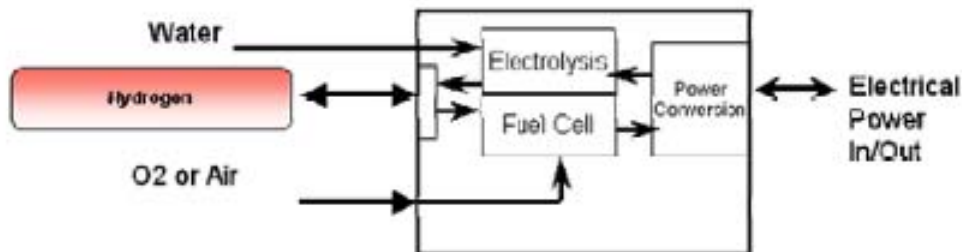

Source: Future Energy Systems (FES)

1.4.1.1 Hydrogen Production by the Electrolysis of Water

Industrial production occurs mainly from the steam reforming of natural gas and less often from more energy-intensive hydrogen production methods like the electrolysis of water (Florida Solar Energy Center, 2007). Most manufacturers employ hydrogen near the production site, with the two largest uses being fossil fuel processing (for example, hydrocracking) and ammonia production, mostly for the fertilizer market. For the application of electricity grid storage, analysts envision production via electrolysis of water.

The electrolysis of water is a simple method of producing hydrogen. Devices run a low voltage current through the water, and gaseous oxygen forms at the anode while gaseous hydrogen forms at the cathode. Typically manufacturers make the cathode from platinum or another inert metal when producing hydrogen for storage. The theoretical maximum efficiency (electricity used versus energetic value of hydrogen produced) is between 80–94percent (Kruse). However, in practice, efficiencies are closer to 60-70percent when analysts include parasitic loads. $2 \text{ H}_2\text{O}(\text{aq}) \rightarrow 2 \text{ H}_2(\text{g}) + \text{O}_2(\text{g})$

1.4.1.2 Hydrogen Storage

For the foreseeable future, manufacturers store hydrogen as a gas at high pressure or as a liquid under cryogenic conditions. Unlike mobile applications, hydrogen density is not generally a problem for stationary applications. As for mobile applications, stationary applications can use established technology:

- Compressed hydrogen in a hydrogen tank (up to 700 bar)
- Liquid hydrogen in a cryogenic hydrogen tank

Underground storage represents another implementation of compressed hydrogen storage, albeit at lower pressures (up to 100 bars) in underground caverns, salt domes, and depleted oil and gas fields. ICI has stored large quantities of gaseous hydrogen in underground caverns for many years without any difficulties (ECN, 1994). The storage of large quantities of hydrogen underground can function as grid energy storage.

1.4.1.3 Conversion to Electricity

A fuel cell is an electrochemical cell that converts energy from a fuel source into electrical energy. The reaction between a fuel supply and an oxidizing agent generates electricity. The reactants flow into the cell, and the reaction products flow out of it, while the electrolyte remains within it. Fuel cells can operate continuously as long as they maintain the necessary reactant and oxidant flows.

Analysts classify fuel cells primarily by the kind of electrolyte they employ. This classification determines the kind of chemical reactions that take place in the cell, the kind of catalysts required, the temperature range in which the cell operates, the fuel required, and other factors (Department of Energy, 2011).

- Polymer electrolyte membrane (PEM) fuel cells have low operating temperatures (~ 80 - 100 C) that allow for fast start up, as would be required in the envisioned energy storage system. PEM fuel cells, with efficiencies of 40 - 50 percent, are the primary type being developed for transportation applications.

- Alkaline fuel cells (AFC) have operating temperatures of 90 - 100 C with efficiencies up to 60percent. Operators primarily use AFCs in space applications where the devices can ensure pure hydrogen and oxygen, since AFCs are extremely sensitive to CO₂ poisoning.
- Phosphoric acid fuel cells (PAFC) were the first fuel cells developers deployed commercially for distributed generation applications. Typical operating temperatures are 150 - 200 C with efficiencies of about 40percent. Engineers can increase overall efficiency in combined heat and power applications. PAFCs have long start-up times, which may restrict their use in energy storage system applications.
- Molten carbonate fuel cells (MCFC) are being developed and deployed for distributed generation. Operating temperatures are 600 - 700 C with efficiencies of 45 - 50percent. The high operating temperatures allow for internal reforming of a variety of fuels as well as combined heat and power applications. However, the high temperatures require long start-up times.
- Solid oxide fuel cells (SOFC) are also high temperature fuel cells utilizing a ceramic electrolyte. Typical operating temperatures are 700 - 1000 C with efficiencies up to 60percent. Manufacturers are developing SOFCs for distributed generation and auxiliary power applications. The high operating temperatures allow for internal reforming of a variety of fuels as well as combined heat and power applications. However, the high temperatures also require long start-up times.

1.4.2 Technology status

Electrolyzers and fuel cells have undergone extensive development in recent years, and several companies are now beginning to commercialize these devices. In comparison with other energy storage methods, electrolyzer/fuel cell systems are at present relatively expensive, with costs of approximately \$3,000 to \$5,000 per kW. However, analysts expect these costs to decline as manufacturers make further technological advances and improvements and produce the systems in greater volumes (Lipman et al, 2005, p. 22).

The three subsystems of a hydrogen energy storage system vary in terms of technology maturity. Hydrogen storage and compression, for example, are well-established, mature technologies for various industrial applications, albeit not necessarily for the subject energy storage application. Steel and now composite pressure vessels with service pressures of up to 700+ bar are commercially available. The main industrial players for large hydrogen storage systems are major international companies that are selling industrial gases, such as Praxair, Air Products, BOC, Linde, or Air Liquide.

Similarly, compressors compatible with hydrogen are also commercially available for industrial applications. For the specific application in an electrolyzer/fuel cell system, the most appropriate technology would be a diaphragm compressor, using a membrane to compress the gas rather than conventional reciprocating pistons, which has proven to be reliable and produce oil and contaminant-free high pressure hydrogen. Compression energy requirements are modest and typically in the range of 0.2 - 0.3 kWh/Newton-meter³ (Nm³) (Pdc Machines, 2011).

Electrolyzers have also found commercial success in industrial applications that require hydrogen on demand. As with most industrial equipment, the term “high volume production” is probably not relevant to electrolyzers - serial production may be better terminology. Several of the key suppliers include Hydrogenics, Proton Energy Systems, and Statoil Hydrogen Systems. The primary electrolyzer products for Hydrogenics and Statoil are based on bipolar alkaline technology. They also both have PEM based systems under development. Proton Energy offers only PEM electrolyzers. Based on company specification sheets, the bipolar alkaline systems of Statoil have the highest efficiency, requiring 4.3 kWh/Nm³. However, this total only includes the electrolyzer (Statoil). Complete integrated systems, as specified by both Hydrogenics and Proton Energy, include not only the power required for the electrolyzer but the ancillary power for the balance-of-plant, including water treatment; cooling, heating and ventilation; and power conditioning systems. Hydrogenics’ bipolar electrolyzer requires 4.8 kWh/Nm³, while its integrated systems range from 5.0 - 5.4 kWh/Nm³ (Hydrogenics). Analysts rate Proton Energy’s systems at approximately 5.2 kWh/Nm³ (Proton Energy Systems, 2011).

Manufacturers are demonstrating and deploying commercially fuel cells for distributed generation and potentially for utility-scale applications, with the support of subsidies to offset capital costs. Manufacturers have demonstrated PAFC’s and deployed 250 kW and 400 kW units commercially since about 1991, primarily by UTC Power. FuelCell Energy has been the primary company deploying MCFCs. The company’s Direct FuelCell® (DFC®) power plants range in output from 300 kW up to 2.8 MW, with the first system going online in 1996. Bloom Energy is selectively deploying SOFC technology with the modular “Bloom Box” 100 kW systems. PEMFC development has focused on transportation, material handling equipment, and back-up power applications, with successful demonstrations. Only Ballard Power Systems is actively pursuing larger, distributed energy applications. Early stationary generation demonstrations by Ballard focused on 250 kW units, with the first prototype demonstration at BC Hydro in 1997 (Ballard, 2009). In 2010, Ballard delivered a 1 MW unit to FirstEnergy for demonstration in Ohio (Ballard, 2011). Specifications for the 1 MW unit state an overall system efficiency of 48percent (Ballard CLEARgen, 2011).

1.4.3 Technology limitations

When considering hydrogen energy storage systems, the primary limitations include the maturity of the fuel cell technology, the durability of fuel cells and electrolyzers, capital cost of fuel cells, electrolyzers, and, to a lesser extent, storage vessels. Efficiencies of fuel cells and electrolyzers and the scale of fuel cells and electrolyzers with respect to grid storage applications also limit the technology. Only Ballard has a few demonstration units of PEM fuel cells (the most appropriate technology for energy storage systems) for stationary applications to indicate maturity levels. As a result of this immaturity, manufacturers have not yet demonstrated the long-term durability of fuel cells in stationary power generation applications.

The efficiency and capital cost characteristics of electrolyzer/fuel cell systems depend on the type of technology utilized, the manner in which operators use the systems (lower load levels generally imply higher efficiency but at the expense of capital costs), and the time frame considered. Costs are relatively high at present, but analysts project them to fall (at an uncertain pace) and efficiency to increase as economies of scale and manufacturing experience take hold and continued technology development occurs (Lipman et al, 2005, p. 22).

One major handicap for this type of system at present is the low round-trip efficiency, reported at approximately 40percent by some sources (Gordes et al, 200). Based on current vendor specifications outlined above, an electrolyzer-compressed storage-fuel cell system today would have a round-trip efficiency of 31-35percent.

In addition, manufacturers have not demonstrated hydrogen electrolyzer/fuel cell technology in the hundreds of MW scale of other energy storage systems, such as CAES and pumped hydroelectric storage (Lipman et al, 2005 p. 23).

1.4.4 R&D Needs and Opportunities

Developers have focused the research and development needs for hydrogen energy storage systems on the identified technology limitations. Recent studies suggest the potential cost effectiveness of hydrogen energy storage for grid applications, providing a rationale to support this research, development, and the demonstration of electrolyzer-compressed storage-fuel cell systems (Schoenung, 2011; Steward et al, 2010 p. 17). Specifically, the industry will need projects that develop and demonstrate MW-scale systems to evaluate and assess actual costs, durability, scale-up, and performance as a distributed energy storage system for renewable energy grid support.

Beyond 2020, focused research and development of regenerative fuel cells has the potential to contribute to the advancement of grid-scale energy storage (Nexight Group, 2010a, p. 37). A variety of technology-specific and crosscutting activities and initiatives could overcome the current gaps and limitations of this technology, including:

- Improving thermal management in endothermic electrolysis reactions and in exothermic fuel cell reactions to create a mid-term market impact.
- Developing alkaline membranes, which do not require the use of precious metals, and extending nano-structured, thin-film catalysts to electrolyzers to increase significantly the potential for regenerative fuel cells to improve grid storage.

Projections from industry experts suggest significant improvements in cost effectiveness (Nexight Group, 2010a):

- Current: \$4,000/kW (alkaline and electrolysis and polymer fuel cell with separate module for electrolysis and for fuel cells)
- 2015: \$2,000/kW (alkaline and electrolysis and polymer fuel cell with one module for electrolysis and regeneration); \$800–\$1,000/kW (solid oxide fuel cell with one module for electrolysis and regeneration)
- 2020: \$1,500/kW (for both types of fuel cells)
- 2030: \$250/kW (for both types of fuel cells)

1.5 General Cost Data for Energy Storage Technologies

This section provides an overview of cost data obtained from existing energy storage projects. Accurate forecasting total installed costs in \$/kW and \$/kWh is challenging given the large ranges of projects and the fact that many technologies are still in the formative stages of commercialization. Some of the data comes from projects funded by the United States Department of Energy's (DOE) Energy Storage Program, which experienced a significant funding boost from the American Recovery and Reinvestment Act of 2009 (ARRA). ARRA grants, however, may not be representative of future installed costs due to the additional administrative expenses needed for these projects (despite the requirement that they be "shovel ready" to be eligible for ARRA funds). Non-ARRA procurements of energy storage systems during the past two years indicate achievement of some reductions in installed costs. Totaling the costs for the technology alone has been difficult because the data do not differentiate between equipment procurement, engineering services, and construction costs. Meanwhile, utilities in Maui, Hawaii; British Columbia, Canada; and elsewhere in the United States have increased their battery capacity in response to assessments that more energy storage capacity

might have helped to avert the Fukushima nuclear crisis. As a result, these purchases for remote applications have helped drive the early adopter market.²

Overall, the DOE noted in February, 2011 that many energy storage technologies are not competitive in capital cost and/or life cycle cost for broad market penetration, although this assessment does not include the potential benefits from the technologies that they currently cannot monetize. The capital cost is at least \$500/kWh in terms of energy or \$2,500/kW in terms of power (Department of Energy. 2011b, p.14). Pumped hydro storage with a low life cycle cost (¢/kWh/cycle) may be an exception, but site selection challenges, large initial investment, long construction time, and environmental concerns may limit the deployment, as discussed previously. The same factors may also hinder deployment of underground compressed air storage. Meanwhile, the CPUC-sponsored cost effectiveness study for the Self Generation Incentive Program (SGIP) reported distributed energy storage unfavorably in terms of societal total resource cost (STRC) (ITRON. 2011).

In recent procurement efforts, utilities and research institutions have noted a disparity between forecasted installed costs for various energy systems from vendors' public presentation and turnkey pricing that is generally not publicly disclosed. KEMA, an international consulting firm to utilities that is active in researching the technical aspects of energy storage performance testing,³ released to industry stakeholders in June 2011 a proprietary energy storage performance modeling tool called ES-Select.⁴ KEMA model's input data for energy storage technologies represent a snapshot figure of costs for various technologies that are likely to be realized over the next one to four years. The figures do not account for the duration of supplied energy and that embed multiple costs that may not be applicable for a particular application, location, or vendor. However, the data provide policy makers and stakeholders with a reference point for determining current costs for specific technologies. As an example of some of the cost data, KEMA found that high energy Lithium Ion batteries had a low scenario total ownership cost (with warranty) of \$3107/kW and a high case of \$3728/kW. Sodium Sulfur batteries had a low case of \$3815/kW and a high case of \$4783/kW. Below ground compressed air ranged from \$899 to \$1169 per kW, while flywheels were \$1454 in a low scenario and \$2631

² See "US studies Fukushima disaster for safety lessons," TerraDaily, April 2, 2011. Available at: http://www.terradaily.com/reports/US_studies_Fukushima_disaster_for_safety_lessons_999.html (created April 2, 2011, last accessed July 8, 2011).

³ For more information about the model tool, see KEMA, Press Release, February 23, 2011. Available at: <http://www.kema.com/news/pressroom/press-releases/2011/KEMA-opens-energy-storage-performance-testing-lab.aspx> (created February 23, 2011, last accessed July 8, 2011).

⁴ To view the source of these data, please access the KEMA website at the following URL: <http://www.kema.com/ES-Select/> (created June 2011, last accessed July 8, 2011).

in a high scenario per kW. Pumped hydro ranged from \$1500 to \$4500 per kW and advanced lead acid batteries were \$2223 to \$3172 per kW for a low to high scenario.

Additional cost data will likely be forthcoming from other studies on these technologies, and KEMA may further refine these numbers in light of industry feedback. As an important caveat for policy makers projecting grid needs for 2020, these figures represent current prices and do not indicate potential and likely price decreases as technological breakthroughs, continued investment, and economies of scale reduce costs.

CHAPTER 2: Regulatory and Policy Framework

Introduction:

The development and deployment of electric energy storage technologies in California will depend, in large part, upon the status of a multitude of policies and regulations, particularly at the state and federal level. These policies can act to encourage and enable private and public utilities, electricity service providers, and end users to include energy storage as a key asset in meeting the state's ambitious renewable energy targets and greenhouse gas emission reduction goals.

A review of the relevant legislative, regulatory, and market measures, as well as of the costs, benefits, and challenges identified in recent studies relating to energy storage, provides a basis for understanding the uses and applications for energy storage, as well as possible regulations and market design changes that might allow for fair valuation and cost recovery on investments in energy storage technologies. This section provides an overview of California's clean energy agenda as it relates to energy storage. In particular, it focuses on the statutory and regulatory framework, and on federal and state agency activities affecting the development and deployment of energy storage technologies. Specifically, this section will review: state planning and policy documents; statewide legislation that relates to or affects energy storage; regulatory and tariff proceedings underway at the CPUC, California Air Resources Board (ARB), Energy Commission, California ISO, and the FERC; utility treatment of storage assets. It will also discuss actions taken outside of California for comparative and illustrative purposes.

2.1 Energy Storage Policy and Regulatory Landscape

2.1.1 California's Clean Energy Policy Push

California's ambitious clean energy agenda places it at the forefront of efforts nationally and globally to increase efficiency, reduce greenhouse gas emissions, and shift to a cleaner and more sustainable energy future. The changes taking place to implement this vision are wide ranging and encompass legislative and regulatory action, private sector and industry initiatives, public-private partnerships, and inter-agency coordination and collaboration. As the state progresses towards its 2020 targets for substantially increased renewable energy resources and reduced greenhouse gas emissions, the potential for energy storage to assist in the integration of renewable resources and the maintenance of a reliable and efficient electric grid takes on great significance.

In 2003, the Energy Commission and CPUC, together with the now defunct California Power Authority, for the first time coordinated efforts to articulate a unified approach for California to meet its electricity needs. This effort resulted in the first *Energy Action Plan (EAP)*, in which the

agencies focused on actions to eliminate outage and electricity price spikes, reward energy efficiency and conservation, and ensure adequate, reliable, and reasonably-priced energy supplies. Most significant may have been the articulation of a preferential “loading order” of cost-effective resources to meet the state’s electricity needs. The loading order, which remains in place today, prioritizes first energy efficiency and conservation, second renewable energy and distributed generation, and third clean, fossil-fuel, central station generation (Consumer Power and Conservation Financing Authority. 2003, p. 4). The loading order also highlights the importance of improving California’s electricity transmission and distribution infrastructure to support the growth of demand centers and interconnection of new resources.

In 2005, the Energy Commission and CPUC produced a second *Energy Action Plan*, focused on the coordinated implementation of specific action areas, consistent with the loading order articulated and expanded to include goals for reducing California’s contribution to climate change. The *Energy Action Plan II* described key actions to maximize energy efficiency measures, implement demand response programs, and meet an accelerated Renewables Portfolio Standard (RPS) of 17 percent renewable by 2010 and 33 percent by 2020. (California Energy Commission. 2005, p.2).⁵ The Plan also emphasized the need for capital investments to support resource adequacy, reliability, and grid infrastructure, as well as the need to encourage research, development, and demonstration of innovative energy technologies, including energy storage (Ibid. p.12).

The baseline policies set forth in the 2003 and 2005 EAPs received an unprecedented push forward with the passage of AB 32, the California Global Warming Solutions Act of 2006. AB 32’s directive for the Air Resources Board (ARB) to adopt regulations to reduce statewide greenhouse gas emissions to 1990 levels by 2020, combined with the April 12, 2011 enactment of California Renewable Energy Resources Act (Senate Bill 2, Simitian) that statutorily mandates the 33 percent renewable electricity generation goal for 2020,⁶ together have created a need for both technological and regulatory solutions that will help California attain its clean energy goals. The Energy Commission’s 2007 *Integrated Energy Policy Report* (IEPR) and the Commission and CPUC’s joint *2008 Energy Action Plan Update* build upon the framework set out by AB 32, identifying nine major action areas for meeting California’s energy needs in a carbon constrained world. Energy storage technologies are relevant to several of these action areas,

⁵ Prior to the April 12, 2011 enactment of the California Renewable Energy Resources Act (Senate Bill 2 Simitian) requiring 33 percent renewable electricity generation by 2020, several actions laid the foundation for the 33 percent requirement. Senate Bill 1078 (Sher, Chapter 51, Statutes of 2002) introduced the initial RPS, setting a goal of 20 percent by 2017. The 2003 Energy Action Plan proposed accelerating the goal to 20 percent by 2010. And Senate Bill 1250 (Perata, Chapter 512, Statutes of 2006) accelerated by statute the goal to 20 percent by 2010.

⁶ Senate Bill 2 (Simitian, Chapter 1, Statutes of 2011).

including: renewable energy; electricity adequacy, reliability, and infrastructure; climate change; and research, development, and demonstration (California Energy Commission. 2008, p.5). Both the 2009 *IEPR* and 2011 *IEPR* Scoping Order identified energy storage as an important subtopic in integrating preferred resources into the electricity system. In addition, Governor Jerry Brown's Clean Energy Plan notes the value of energy storage for renewables integration and its economic and job creation potential if utilities were to procure storage equivalent to 5percent of their peak load demand.⁷

The 2009 *IEPR* (Integrated Energy Policy Report) gave extended treatment to energy storage. It listed existing and emerging storage technologies as a key component to integrating large amounts of renewable generation into the electricity grid. Specifically, the report identified the value of energy storage technologies for generation, transmission and distribution, and end-use applications. At the generation level, the Energy Commission noted energy storage technologies' ability to provide ancillary and renewable integration services, such as grid frequency regulation. At the transmission and distribution levels, the report noted the values of load shifting, transmission congestion relief, increased reliability, and capital deferral. And at the end user level, the Energy Commission noted the value for commercial and industrial users to obtain peak shaving, backup power, and increased reliability. The Energy Commission identified these values in the context of the loading order preferences for meeting energy supply needs, the requirements set by AB 32 and California's RPS, and the Energy Commission's ten year electricity demand forecast (California Energy Commission. 2009, pp. 5, 87, 193-06).

The 2009 *IEPR* also compared the value offered by electric energy storage to counteract effects on local system reliability due to the operating characteristics of wind and solar power to that provided by gas-fired generation. It recognized that "some of the firming services provided by gas-fired generation will need to come from existing and emerging energy storage technologies that allow generators and transmission operators to fill the gap between the time of generation (off-peak) and the time of need (on-peak) for intermittent renewable energy" (California Energy Commission. 2009, p. 193). It found that storage can respond to intermittency and fast drop off and pick up rates more quickly than natural gas generation, potentially better addressing the severe ramping rates associated with wind and photovoltaic solar and reducing the overall amount of energy needed to balance the system and maintain reliability (although energy storage devices lose some energy through conversion). The Commission recommended that California pursue the following applications for energy storage:

⁷ To review Governor Brown's proposal, please visit: http://www.jerrybrown.org/Clean_Energy (created June 15, 2010, last accessed July 7, 2011)

- Ancillary services that otherwise would be provided by conventional fired plants to integrate large amounts of renewables;
- Utility scale storage to avoid cutting wind production in response to transmission limits;
- Load shifting / shifting renewable production to times of higher demand, which also helps to address surplus generation;
- Fast response storage for electricity system stability and to reduce frequency response problems.

In 2010, the Energy Commission focused the *IEPR Update* on the American Recovery and Reinvestment Act of 2009 (ARRA) stimulus funding for clean energy projects. Energy storage appeared in the Commission's discussion of California's renewable electricity goals, smart grid development, and as a beneficiary of the private-public partnerships that leveraged ARRA funding for research, development, and pilot projects. The 2010 *IEPR Update* emphasized the role of government during the current phase of emerging clean technologies as "crucial" to establish "policies that provide long-term market signals, performance standards, and incentives to encourage private investment." (California Energy Commission. 2010a, p.11). The role of California's energy regulatory agencies in moving forward policies and regulatory changes to support energy storage deployment is addressed in detail in Chapter 2 of this report.

In this year's *IEPR*, the Energy Commission will focus on electricity infrastructure needs based on the level of preferred resources expected to be in place in the next decade. The 2011 *IEPR* Scoping Order reiterates the potential value of energy storage discussed in previous *IEPRs* and identifies storage as an important subtopic of this year's report (California Energy Commission. 2011a, p.3). The expanded treatment that energy storage will receive in the 2011 *IEPR* is consistent with the recent legislative mandate under AB 2514 for adoption of a more concrete energy storage agenda for California, and with the increased role for storage systems implicated by California's RPS and greenhouse gas emission reduction goals. As stated by the state's lead energy and environmental agencies in their paper on California's Clean Energy Future, Collaborative Vision for 2020, "Energy storage will be a significant feature of the cleaner power system. As a result of agency support for storage technology pilot studies, increased utility-scale and aggregated smaller-scale storage technologies ... will be available to help facilitate integration of intermittent wind and solar renewables resources," as well as to shift peak demand to off-peak hours and to provide ancillary services to grid operations (California Environmental Protection Agency. 2006, p.7).

Efforts by federal agencies and legislators to include energy storage in plans for the nation's clean energy future reinforce the steps taken by California policymakers. In an extensive effort

to outline policies for the twenty-first century electric grid, the President's Executive Office and National Science and Technology Council have stated that energy storage can help facilitate a clean energy economy:

Energy storage systems have the potential to optimize the operating capabilities of the grid and the use of renewable energy by storing power for later use. Such systems can work more effectively in tandem with smart grid technology, can augment demand response resources to reduce and shift peak energy loads, and can improve power quality and service reliability. Significantly, utility-sited energy storage can be used to avoid or delay investments in new distribution capacity and substation equipment (Executive Office of the President. 2011, p.15).

The American Recovery and Reinvestment Act invested \$685 million in smart grid and energy storage demonstration projects, laying a foundation for utilities and industry to partner with the government and enable the real-world testing and development necessary for energy storage to gain ground. Other important actions at the federal level that could affect storage deployment in California include Oregon Senator Ron Wyden's plans to reintroduce legislation that would create an investment tax credit specific to grid-connected energy storage properties, the STORAGE 2011 Act, and FERC's regulatory processes to evaluate the treatment of energy storage in the wholesale energy markets, discussed below in Section 2.1.3.1.

2.1.2 Legislative Mandates: AB 2514, AB 32, and California's RPS

Several legislative mandates establish the basic framework upon which policies and regulations relating to energy storage in California will be built. The California legislature passed AB 2514, the foremost statute relating to utility procurement of energy storage systems, in September 2010. AB 2514 makes numerous findings regarding the value of energy storage and the significant barriers that hinder its timely implementation. The broader mandates for the reduction of greenhouse gas emissions under AB 32, and for increased renewable energy generation under the Renewables Portfolio Standard, create incentives for the state to develop and effectuate a vision for energy storage by 2020 and to evaluate targets in accordance with AB 2514. In addition are several laws that support investments in renewable energy and smart grid systems, which may rely on or benefit from energy storage technologies. These include the Self-Generation Incentive Program (SB 412), Smart Grid Systems (SB 17), and the California Solar Initiative (SB 1).

Under AB 2514, the legislature finds that expanding the use of energy storage systems can assist load serving entities (LSEs) "in integrating increased amounts of renewable energy resources into the electrical transmission and distribution grid in a manner that minimizes emissions of

greenhouse gases,” and can help “optimize the use” of the variable, intermittent, and off peak electrical generation from wind and solar energy. It can reduce costs to ratepayers based on deferred or avoided new peaker plants and transmission-distribution upgrades and expansions, and will reduce the use of fossil-fuel generated electricity at peak, reducing carbon and criteria pollutant emissions (AB 2514 [Skinner, Chapter 469, Statutes 2010], Sec. 1). AB 2514 identifies certain significant barriers to obtaining these benefits, including inadequate evaluation of energy storage as part of the state’s long-term electricity resource planning, lack of recognition of advancements in storage technologies, and “inadequate statutory and regulatory support” (Ibid., Sec. 3(f)). The statute directs the CPUC to open a proceeding to determine appropriate targets, if any, for LSEs to procure energy storage systems by December 31, 2015 and December 31, 2020 and for publicly owned utilities (POUs) to do the same on a slightly deferred schedule, by December 31, 2016 and December 31, 2021. It also provides guidance to the CPUC regarding the information the agency should consider in the rulemaking, the attributes and electricity dispatch characteristics of energy storage technologies within the meaning of the statute, and the need to weigh technological feasibility and cost effectiveness for any procurement targets (Ibid. Sec. 2).

If the CPUC determines it appropriate to set targets for energy storage procurement, it must adopt those targets for non-POU electric corporations by October 1, 2013 and reevaluate them no less than once every three years. The CPUC proceeding and stakeholder input is reviewed in more detail below, and though it constitutes the most direct driving force behind current discussions on energy storage, California’s broader climate change policy forms an arguably equally important driver.

The California Global Warming Solutions Act of 2006, AB 32, represents California’s landmark legislation and dominant force behind the state’s recent clean energy push. Its findings include that global warming poses a serious threat to the state’s economic, environmental, and public well-being, and that “investing in the development of innovative and pioneering technologies will assist California in achieving the 2020 statewide limit on emissions of greenhouse gases... and will provide an opportunity for the state to take a global economic and technologic leadership role in reducing emissions of greenhouse gases” (Assembly Bill 32 [Núñez, Chapter 488, Statutes of 2006], Section 38501(e)). AB 32 directs the state Air Resources Board (ARB) to adopt regulations that will return greenhouse gas emissions for California to their 1990 levels by 2020. The ARB must design the regulations based on maximum technological feasible and cost effectiveness to minimize costs and maximize benefits for the state’s economy, energy infrastructure, and environment (Ibid. Sec. 28560, 38501).

In December 2008, in accordance with AB 32, the ARB adopted a Scoping Plan that sets forth the measures to be developed and implemented by January 2012. The Scoping Plan touches on

nearly every sector of the state economy, from energy efficiency, building and appliance standards and transportation to development of a regional carbon market (California Air Resources Board, 2008). Several areas of pending regulation will affect the role of energy storage, including the RPS, carbon cap and trade, and the Million Solar Roofs/ distributed generation program. The development of these regulations in many cases overlaps with proceedings underway at the ARB and the CPUC. The following section on Institutional and Regulatory Action provides a brief review of the scope and status of these proceedings and their potential effect on policies for energy storage system development and deployment.

The Renewables Portfolio Standard (RPS) serves as yet another major driver behind expanded deployment of energy storage in California. Under Senate Bill 107, California's investor-owned utilities (IOUs) needed to procure 20 percent of their electricity from renewable resources by 2010 (Senate Bill 107 [Simitian, Chapter 464, Statutes of 2006]). With the recent passage of the California Renewable Energy Resources Act (Senate Bill 2 [Simitian, Chapter 1, Statutes of 2011]), California increased the percentage to 33 percent by December 31, 2020, codifying regulations issued by ARB in response to an executive order from Governor Schwarzenegger.

The new law requires the CPUC to establish procurement targets sufficient to ensure that the 33 percent target is met and retained in subsequent years, and that an interim target of 25 percent of retail electricity sales from qualifying renewable resources is met by December 31, 2016 (Senate Bill 2). One notable change is that the CPUC will no longer calculate procurement targets for renewable resources in relation to a market price referent (MPR), but instead will establish a cost limitation on how much each electrical corporation can spend on renewable energy procurement expenditures. Exceptions to the renewable procurement standard will exist if a retail seller cannot meet its obligations within the cost limitations set by the CPUC. The renewable procurement requirements will apply equally to publically owned utilities, although implementation will be the responsibility of the POU governing board, not the CPUC. A determination by the CPUC of the load carrying capacity of wind and solar energy resources will be used to evaluate the contribution of wind and solar toward meeting resource adequacy requirements. The law also requires the Energy Commission to adopt regulations for the enforcement of the RPS and for the design and implementation of an accounting system to verify compliance. Important to the prospects for energy storage deployment, the bill requires the California ISO to integrate and interconnect renewable energy resources to the grid in "the most efficient means possible with the goal of minimizing the impact and cost of new transmission facilities needed to meet both reliability standards" and the RPS targets (Senate Bill 2, Simitian) Sec. 399.26(b) (1)).

Even prior to the passage of SB 2, California's energy agencies have been working in preparation of the 33 percent RPS. In the 2005 *Energy Action Plan II*, the CPUC and Energy

Commission identify the steps necessary to achieve 33 percent by 2020 (California Energy Commission, 2005, pp. 5-6). The AB 32 Scoping Plan similarly accounts for the 33 percent target in its analysis of greenhouse gas emission reductions by 2020. And the ARB published its proposed RES regulations in June 2010, which are intended to complement and build upon the RPS program, but not to alter or replace it (California Air Resources Board, 2010a).

By 2010, the three large investor owned utilities (IOUs) had not met the 20 percent RPS target, but reported servicing about 18 percent of their retail electricity sales from renewable energy. The CPUC's *RPS Quarterly Report* for Q4 2009 anticipated that the 20 percent RPS goal would be met in the 2013-14 timeframe (California Public Utilities Commission, 2009a, p.4). Because numerous contracts for new renewable resource capacity were added in 2010, the CPUC more recently reported that the IOUs were forecasted to achieve 20 percent RPS in the 2011-12 timeframe (California Public Utilities Commission, 2011a, p.5). California ISO has expressed confidence that California's electricity system is equipped to integrate the amount of renewable resources expected to come online in the next 1-2 years. However, it has identified the need to evaluate changes to the wholesale market design to accommodate the growing amount of renewables as the state advances towards the 33 percent RPS (California Independent System Operator, 2010a, p.3). The following section reviews the activities of California ISO and FERC, as well as the CPUC and ARB, which are directed at facilitating the integration of renewable generation and improving the efficiency and reliability of the grid.

2.1.3 Institutional and Regulatory Action: Regulatory Proceedings and Rate Cases

There are numerous regulatory activities underway at the state and federal level that will impact the market for electric energy storage. These activities include tariff and market rule reviews at California ISO and FERC, multiple proceedings underway at the CPUC, and ARB rulemakings to implement the scoping plan under AB 32. In addition to agency activities, investor-owned utility rate case applications, smart grid deployment plans, and permanent load shifting proposals as presented to the CPUC shed light on how the large IOUs intend to include energy storage in their portfolios based on the existing regulatory framework.

The remainder of this section reviews the status of the regulatory proceedings named above, briefly summarizing stakeholder input when appropriate, and highlights several utility proposals for the inclusion of energy storage assets in the procurement and smart grid planning processes.

2.1.3.1 California ISO and FERC: Wholesale Energy and Ancillary Markets

As part of the market design review for 33 percent renewables integration, California ISO has engaged with stakeholders in a two-phase *Renewable Integration: Market and Product Review* process to identify and define new market products and improvements needed to support

renewable integration. Phase 1 of the market and product review process will implement near-term changes within 1-2 years that are anticipated to provide benefits in any future renewable resource scenario (California Independent System Operator, 2011b, p.1). Phase 2 will develop longer-term solutions, focusing on “the most effective and robust solutions to the new challenges and requirements rather than the most expedient or easiest to implement,” and will take “a holistic view” that accounts for the interactions between distinct market elements (California Independent System Operator, 2011c). Some of the proposed market design elements under consideration in Phase 2 include pay for performance regulation in accordance with the FERC Notice of Proposed Rulemaking (NOPR) discussed below, a load-following reserve requirement, a methodology to allocate the costs of integrating increased amounts of variable renewable energy resources, and modifications to intra-day market settlements.

In conjunction with the market and product review process to support renewables integration, California ISO has initiated changes to facilitate the provision of energy storage resources for ancillary service⁸ needs. FERC simultaneously has proceedings underway to remove unnecessary barriers to transmission service and wholesale markets for variable energy sources⁹ and technologies that may facilitate their integration, the results of which are likely to affect California ISO’s tariffs and ultimately the deployment of energy storage technologies in California.

In 2007 and 2008, the FERC issued Orders 890 and 719, which together required regional system and transmission operators to allow demand response technologies to compete in ancillary services if they met technical requirements and could bid at or below market price; and for non-generation technologies, including energy storage, to be evaluated on a comparable basis with generation sources to meet reliability requirements, ancillary services needs, and plans for grid expansion (Federal Energy Regulatory Commission, 2007; *Ibid.*, 2008a.). In response, California ISO initiated a proceeding to consider changes to operating and technical requirements in the ancillary services market to facilitate the participation of non-generator resources. In March 2010, the California ISO Board approved the changes discussed below, and in May 2010 they published draft revised tariff language for non generator resources (See California Independent System Operator, 2010c; *Ibid.* 2010b, Sec. 8.2.3.5(c)).

⁸ According to the California ISO, for the purpose of the relevant proposed tariff language, ancillary services are: (i) Regulation Up and Regulation Down, (ii) Spinning Reserve, (iii) Non-Spinning Reserve, (iv) Voltage Support, and (v) Black Start capability. See California Independent System Operator. 2010b, p.1.

⁹ Variable energy resource is the term used by FERC to describe renewable energy resources that have variable or intermittent production characteristics.

The modifications to the ancillary services market include: (1) a technology-neutral definition of ancillary services resource as "any resource meeting the operating characteristics and technological requirements for each ancillary service," which definition will align with the Western Electricity Coordinating Council's pending change to the definition of spinning reserve such that it is no longer limited to generation resources (2) a reduced continuous energy requirement for ancillary services from 2 hours to 60 minutes for day ahead regulation up/down, and to 30 minutes for real time regulation up/down, spinning reserve, and non-spinning reserve; (3) an altered protocol for measurement of the continuous energy requirement that will begin at the moment the resource reaches its award capacity, not at the end of the minimum 10-minute ramp time; and (4) a reduced minimum rated capacity requirement from 1MW to 500KW (California Independent System Operator, 2010c, pp. 3, 10-11) ;¹⁰. These changes lay the groundwork for increased participation of energy storage and other non-generation resources in the ancillary services market and open the door to a cost-effectiveness methodology that incorporates ISO tariffs for unbundled ancillary services applications. For example, the proposed tariffs allow Spinning Reserve and Regulation Up from the same resource to be provided as separate ancillary services, provided that their sum "is not greater than the maximum Ramp Rate of the resource (MW/minute) times ten (10)" (California Independent System Operator, 2010b).

However, these changes still limit participation in the real time market or day ahead market to those storage resources which can discharge or charge for more than 29 minutes or 59 minutes, respectively. Many limited energy storage resource (LESR) technologies, such as flywheels, some batteries, and some demand response technologies, have the ability to provide valuable regulation services to the grid because of their fast ramping, but not in the required time scale. To address this gap, California ISO proposed a Regulation Energy Management (REM) methodology, which the California ISO Board of Governors approved on February 3, 2011 (California Independent System Operator Board of Governors, 2011d). The REM option complements the changes to the ancillary services market because it allows a LESR that otherwise would be regulated out of participation in the day ahead market to participate by purchasing or selling energy in real-time (California Independent System Operator, 2011e, p.3).¹¹ By opting for REM, a LESR allows California ISO to manage its state of charge, enabling

¹⁰ As proposed by WECC, and pending approval by FERC, the definition of spinning reserves would change from "unloaded generation which is synchronized and ready to serve additional demand" to a resource that "immediately and automatically responds proportionately to frequency deviations." See California Independent System Operator. 2010c, p.3.

¹¹ Only limited energy resources that require a real-time energy offset can qualify for REM; these may include flywheels, some batteries, and some demand response resources.

it to meet the one hour duration requirement for regulation purchased in the day ahead market. Based on modeling exercises of REM functionality under realistic system conditions and renewable integration studies under 20 percent RPS, California ISO concluded that REM will help address future system requirements by facilitating regulation by limited energy resources, even if the specific capacity required under 33 percent RPS is yet unknown (Ibid., pp. 5, 7).

Settlement to LESRs for provision of regulation services through REM will be in the form of a capacity payment, the same as for traditional regulation in the day ahead market (California Independent System Operator, 2011e, p.13).¹² Some stakeholders advocated for an additional “mileage payment” to regulation resources, which would account for the sum total of all injections to or withdrawals from the system in response to ISO regulation signals. California ISO recognizes the potential merit of such payment and has included exploration of “pay for performance” mileage payments in the scope of phase 2 of the *Integration of Renewables, Market and Product Review*. A mandated “mileage” component for frequency regulation payments may stem from recent activities at FERC, the results of which will determine further changes to California ISO’s actions to facilitate increased participation of non-generator resources in the ancillary services markets.

On February 17, 2011, FERC issued a Notice of Proposed Rulemaking (NOPR) for Frequency Regulation Compensation in the Wholesale Power Markets, which would affect California ISO’s tariff for regulation services. In the NOPR, FERC found that current compensation methods in the ISO and RTO markets may not acknowledge the benefits that fast-ramping resources, such as flywheels and battery systems, bring to frequency regulation over the capabilities of traditional generators, resulting in tariffs that may not compensate regulating resources accurately to reflect the services performed (Federal Energy Regulatory Commission, 2011, pp.1-3, 15-16). To remedy any discriminatory compensation practices, FERC proposed that frequency regulation compensation in the ISO/RTOs reflect a two-part payment structure derived from current best practices. The two parts are (1) a uniform capacity payment for the amount of capacity held in reserve to provide frequency regulation service, which also would include the marginal opportunity costs of the regulating resource, and (2) a performance or “mileage payment” based upon the absolute MW up and down that the resource provides in response to control signals, which also would include a measure for the resource’s response accuracy (Ibid., pp. 21-22). FERC sought comments to its proposed payment structure, including whether the performance payment should be set by the market or administratively

Conventional generation resources may continue to provide regulation services in the day-ahead market, but may not select REM. (California Independent System Operator, 2011e, p.12).

¹² A capacity payment is calculated based on the capacity set aside by the resource to provide the service requested.

and how the payments should incorporate accuracy. If approved, the incorporation of mileage and accuracy payments into the traditional capacity-based compensation structure for regulation services would have the potential to increase revenues for fast-response storage developers and to increase their market participation.

FERC also issued a Request for Comments Regarding Rates, Accounting, and Financial Reporting for New Electric Storage Technologies to better understand the various ways in which electric storage can be used, where those uses fall within established jurisdictional boundaries, and the appropriate rate treatment, classification, and reporting requirements for those uses (Federal Energy Regulatory Commission, 2010). FERC's leaders have been particularly interested in the development of rate policies that accommodate and value the flexibility of storage technologies. In their Request for Comments, FERC staff outlined the agency's initial position on the uses of storage and highlighted a number of questions that they seek to answer. These include: When can storage be classified and compensated as a transmission asset? When, if ever, can storage receive compensation both as transmission and for enhancing the value of generation or for providing ancillary services? Should policy makers consider developing stand-alone contracts for storage services? And do policy makers need new accounting and reporting requirements to facilitate cost of service ratemaking for storage technologies? (Federal Energy Regulatory Commission, 2010, Sec. 36382).

Over 60 stakeholders filed responses to FERC's Request for Comments, providing a wide range of feedback. Amongst the California and nationally-based responses, a large number supported the possibility of energy storage cost recovery in transmission rates, so long as FERC establishes criteria and safeguards to prevent unfair advantage or double recovery.¹³ For example, storage serving transmission needs would be subject to system operator control but without the requirement that the system operator become a market participant. As expressed by the National Alliance for Advanced Technology Batteries, "concern about possible cross-subsidization, unfair competition and double recovery ... are proper regulatory concerns. However, a simplistic solution that forces storage into a single category is not sound policy."¹⁴ Several of these parties emphasized the need for policy makers to support the emerging energy storage market by creating new regulations that are not overly restrictive and that allow entities

¹³ See Federal Energy Regulatory Commission. Docket AD10-13, Comments of: Southern California Edison Co.; San Diego Gas & Electric; National Hydropower Association; National Electrical Manufacturers Association; National Alliance for Advanced Technology Batteries; Electric Power Supply Association; California Energy Storage Alliance; Electricity Storage Association. Even those responses that oppose rate treatment for energy storage suggest safeguards that would be necessary, should it be allowed at all. See *ibid.*, Comments of California Dep't of Water Resources and State Water Project.

¹⁴ *Ibid.*, Comments of The National Alliance for Advanced Technology Batteries, p. 5.

to use the diverse values and flexible functions of storage in a number of ways, both rate-based and market-based.¹⁵

Numerous responses, however, disagreed, based on the complications that arise if transmission operators participate in the energy market and because transmission applications identified for storage devices are essentially the same as those of generation and market-based demand response and may be covered under those rates.¹⁶ California ISO staff cautioned FERC against classifying an energy storage device providing a service like voltage support as a transmission asset, because it blurs the line between transmission and generation. Instead, FERC should limit the classification of energy storage as a transmission asset to the unique situations in which the technology's operation justifies the classification. But in this case, policy makers should allow the technology to serve transmission functions only. California ISO noted that storage devices competing directly with generation and demand response resources could cause price distortion if policy makers allow cost recovery for services such as transmission congestion and deferment of transmission upgrades.¹⁷

Regarding dual classification as a transmission asset and either a generation or ancillary service enhancement, numerous responses suggested that FERC could develop rules to define the means of participating in each market and to ensure cost recovery that does not overcompensate or cross-subsidize.¹⁸ Several comments among this group suggested that FERC classify storage devices on a case-by-case basis depending on the intended use and capabilities,

¹⁵ Ibid., Comments of: National Electrical Manufacturers Association; National Alliance for Advanced Technology Batteries; Electric Power Supply Association; California Energy Storage Alliance; Project for Sustainable FERC Energy Policy, on behalf of several public interest and environmental organizations.

¹⁶ Ibid., Comments of: Six California Cities; California ISO; Transmission Agency of North America; Transmission Agency of Northern California; City of Santa Clara, California and the M-S-R Public Power Agency; California Dept. of Water Resources and State Water Project.

¹⁷ Ibid., Comments of California ISO. See also Comments of: Transmission Agency of Northern California; City of Santa Clara, California and the M-S-R Public Power Agency; California Dept. of Water Resources and State Water Project; American Public Power Association; Electricity Consumers Resource Council (arguing that energy storage as both a transmission service and a competitive energy service creates special preference discrimination for storage facilities and opens the door to double recovery or double charging of customers for the same facilities).

¹⁸ Ibid., Comments of: Southern California Edison Co.; National Hydropower Association; National Alliance for Advanced Technology Batteries; Electric Power Supply Association; Electric Power Supply Association; California Energy Storage Alliance; Coalition to Advance Renewable Energy Through Bulk Storage; Electricity Storage Association; Project for Sustainable FERC Energy Policy, on behalf of several public interest and environmental organizations.

subject to a defined criteria, and where “intended use and capabilities” included flexibility to allow storage units to perform different functions at different times.¹⁹ But the California ISO and others argued that allowing dual cost recovery would greatly increase the operational complexity between transmission system and storage operators and create unacceptable risk that the storage technology would not operate as directed because of competing economic priorities, causing reliability and cost-based recovery concerns,²⁰ in addition to the subsidization and double recovery concerns noted above. Several entities, regardless of their position on allowing cost recovery through transmission rates, supported exploration of a contract-based approach to storage services, possibly using interstate natural gas storage facility stand-alone contract options as a model.²¹ Others cited the lack of any parallel between gas and electric storage and the challenge of implementing stand alone contracts for storage.²²

Stakeholders disagree over the need or benefit of creating new accounting or reporting requirements for energy storage, as opposed to establishing additional subaccounts within already-existing facility functions.²³ The M-S-R Public Power Agency, representing Modesto Irrigation District, the City of Santa Clara, and the City of Redding, pointed out that limiting any transmission rate recovery of storage technologies to single-purpose facilities will reduce the need for accounting changes. However, if FERC allowed multiple use storage projects to recover costs through transmission rates, then accounts will need to track and ensure that costs resulting from market functions are not charged to the transmission function.²⁴ According to the comments of the CPUC, FERC currently lacks sufficient information to make generalized cost recovery and accounting and financial reporting determinations and should proceed on a

¹⁹ Ibid., Comments of: Coalition to Advance Renewable Energy Through Bulk Storage; Southern California Edison; National Rural Electric Cooperative Association; Edison Electric Institute.

²⁰ Ibid., Comments of California ISO.

²¹ Ibid., Comments of: California ISO; Electric Power Supply Association; Edison Electric Institute; California Energy Storage Alliance.

²² Ibid., Comments of: Southern California Edison; National Rural Electric Cooperative Association.

²³ Ibid. *Compare* Comments of: Six California Cities; American Public Power Association; California Energy Storage Alliance (supporting establishment of a separate accounting framework for energy storage) *with* Comments of: Southern California Edison Co.; San Diego Gas & Electric; National Rural Electric Cooperative Association; Edison Electric Institute (arguing storage can be accounted for under existing plant functions).

²⁴ Ibid., Comments of: Transmission Agency of Northern California; City of Santa Clara, California and the M-S-R- Public Power Agency.

case-by-case basis until policy makers develop a better understanding of the varied uses of storage in the electric system.²⁵

2.1.3.2 California ISO: Participating Intermittent Renewables Program

The Participating Intermittent Renewables Program (PIRP) represents another California ISO program undergoing revisions as part of the *Renewable Integration: Market and Product Review*. The PIRP allows intermittent resources, like wind and solar, to schedule energy in the forward market without incurring imbalance charges when the delivered energy differs from the scheduled amount. Instead, grid operators net deviations from ten-minute settlement intervals across a calendar month and settle them at a weighted-average price (California Independent System Operator, 2006, p.1). California ISO staff will file proposed changes to the PIRP, stemming from the Renewable Integration stakeholder process, in the coming weeks. These changes may include modification of intra-hour scheduling to increase California ISO operating flexibility, the measuring of deviations closer to real-time, and adjusting the settlement system for market participants (Miller, 2011, pp.21-24). If the new PIRP implements a policy of imbalance charges for deviating from forecasts, energy storage could play a valuable role in firming and shaping participating wind and solar resources. Generators that couple with onsite or co-located storage have the potential to mitigate deviations by providing firm power in accordance with the forecasted amount.

2.1.3.3 California ISO: Transmission Planning and Interconnection Procedures

Transmission planning, and the rules affecting transmission and interconnection cost and cost recovery, may impact the cost and value of energy storage technologies. Energy storage can serve to reduce transmission congestion, but transmission planning rules determine the likelihood that utilities can recover costs for investing in these technologies. California ISO's Generator Interconnection Procedures (GIP), based on FERC's conditional approval of the GIP in December 2010, govern transmission upgrades and generator interconnection for both small and large projects (California Independent System Operator, 2011f, p.7). One important policy that California ISO leaders will consider in the near term is how to distinguish between network upgrades that will receive full funding by transmission ratepayers versus network upgrades for which the interconnection customer will bear non-refundable cost responsibility. Where project developers bear the cost responsibility or must pay an upfront share, transmission upgrade deferrals, potentially facilitated by the implementation of energy storage technologies, may become more attractive.

California ISO's Economic Planning Study represents another aspect of transmission planning that is pertinent to energy storage valuation. The study will identify congestion in the

²⁵ Ibid., Comments of California Public Utilities Commission.

transmission system and compare the economic benefit of a proposed mitigation measure to the costs, to determine whether the mitigation solution is cost effective (California Independent System Operator, 2011g).

Since grid operators can place energy storage devices at points of congestion along the transmission grid, these devices should receive consideration under California ISO's study. Moreover, the study should compare the cost effectiveness of transportable versus stationary energy storage solutions for grid support, a distinction made by EPRI in its *White Paper Primer on Applications, Costs, and Benefits* for energy storage technologies (Electric Power Research Institute, 2010, Table ES-1).

2.1.3.4 California Public Utilities Commission

The CPUC is engaged in multiple proceedings that relate to energy storage. Foremost is the rulemaking process pursuant to AB 2514. The AB 2514 rulemaking will enable the "review and possible adoption of viable, cost-effective energy storage technologies because they may provide a strategy for meeting the state's long-term clean energy goals while maintaining system reliability" (California Public Utilities Commission, 2010a, pp. 4-5). Its purposes include: (1) review and establish, if appropriate, opportunities for energy storage development and deployment in California; (2) reduce barriers to such development and deployment; (3) review and weigh the costs and benefits of such development and deployment; and (4) establish methodologies that address how those costs and benefits should be distributed. Thus, the AB 2514 rulemaking provides the CPUC with an opportunity to "continue its rational implementation of advanced sustainable energy technologies and the integration of intermittent resources in our electricity grid." (Ibid. p.1).

The CPUC released the scoping memo for the AB 2514 rulemaking, dividing the process into two distinct phases, to be resolved prior to any determination on procurement targets. Phase 1 will establish policies and guidelines for energy storage in California, based on the energy storage technologies and applications currently in use, the policies needed to encourage energy storage for environmental and grid related objectives, barriers to energy storage adoption, and the relationship between energy storage and other state policy priorities and mechanisms for meeting state energy goals. Phase 2 will result in a cost-benefit analysis to measure the value of energy storage attributes and applications, considering costs, system and other benefits, and allocation of costs and benefits amongst retail end-use customers (California Public Utilities Commission, 2011b).

Based on initial comments submitted by stakeholders, parties generally support the opportunity to consider these issues in a rulemaking. Opinions were varied as to the readiness of storage technologies for cost-effective implementation, the appropriate methodology for evaluating and

monetizing the costs and benefits of storage, and whether the scope of the proceeding should extend to issues such as dynamic pricing and rate recovery. Most comments cited the need for the CPUC to create a valuation framework for energy storage technologies.²⁶ Several stakeholders have recommended development of a framework that would enable cost-benefit comparisons of storage with different types of resources, as well as with other load shifting and emissions reducing strategies.²⁷ The California Energy Storage Alliance (CESA) emphasized the importance of a valuation framework that analyzes energy storage technologies at the application or use case level, to account for the differences in system size, duration of capacity, lifecycle and response time. Comments by a number of other stakeholders affirmed the soundness of an application-specific approach²⁸. Comments also encouraged an approach that quantifies the ancillary and environmental quality benefits of energy storage.²⁹ Other stakeholders have emphasized that any valuation framework must protect against any “double-counting” of benefits due to overlapping value categories.³⁰

Stakeholders have expressed an interest in how this CPUC proceeding will impact other CPUC and state agency proceedings. A few stakeholders suggested that this proceeding serve as an “umbrella” to coordinate development of energy storage policy across existing and future proceedings. As the AB 2514 proceeding moves forward, the CPUC should provide a transparent analytic framework that outlines its proposed valuation methodology to allow stakeholders to provide responsive feedback and to offer clarity to participants in parallel proceedings regarding the reach of the AB 2514 rulemaking.

Other areas under CPUC jurisdiction that may affect or be affected by the outcomes of the AB 2514 proceeding include distributed generation and the Self-Generation Incentive Program (SGIP), smart grid, permanent load shifting, demand response, dynamic pricing, and continued RPS compliance through the LTPP process.

2.1.3.4.1 Smart Grid

²⁶ See California Public Utilities Commission, Docket R10-12-007, <http://docs.cpuc.ca.gov/published/proceedings/R1012007.htm>. Comments of: A123 Systems; Beacon Power Corp.; Brookfield Renewable Power Inc.; California ISO; Calpine Corp.; California Energy Storage Alliance; Environmental Defense Fund; Western Power Trading Forum.

²⁷ Ibid., Comments of: California ISO; Calpine Corp.; Division of Ratepayer Advocates; Western Power Trading Forum.

²⁸ Ibid., Comments of California Energy Storage Alliance ; Southern California Edison Co.; San Diego Gas & Electric; Consumer Federation of California.

²⁹ Ibid., Comments of Environmental Defense Fund.

³⁰ Ibid., Comments of Calpine Corp.

Since 2008, the CPUC has been engaged in a rulemaking proceeding to develop Smart Grid policies and protocols to guide the investor-owned utilities in efforts to modernize the electric grid. Federal and state law help direct the CPUC's activities in this arena. California's Senate Bill 17 defined a broad set of characteristics pertaining to a Smart Grid and directed the CPUC to establish requirements for a smart grid deployment plan that improves "overall efficiency, reliability, and cost-effectiveness of electrical system operations, planning and maintenance" (Senate Bill 17 [Padilla, Chapter 327, Statutes of 2009], Sec. 8360, 8362). Deployment plans must be consistent with federal standards, which require electric utilities to consider investments in qualified smart grid measures prior to investing in "nonadvanced grid technologies" and require state public utility commissions to consider authorizing utilities to obtain ratepayer recovery for expenditures related to smart grid system deployment (Energy Independence and Security Act of 2007 [42 U.S.C. Sec. 17001, et seq.], Sec. 1307). In its decision providing guidance to the IOUs for their deployment plans, the CPUC stated that a purpose of the Smart Grid is to "enable the integration of higher levels of renewable energy, energy storage, and, eventually, electric vehicles, at a lower cost to consumers" (California Public Utilities Commission, 2010b, p.2). The IOU's first Smart Grid Deployment Plans are due to the CPUC in July 2011 and may provide insight into how the utilities intend to include or pursue energy storage as part of their smart grid plans.³¹ Additionally, eight California smart grid and energy storage demonstration projects that received \$186 million in stimulus funding through the DOE competitive process are likely to provide critical data points for current assessments of energy storage performance potential.

2.1.3.4.2 Self-Generation Incentive Program

The CPUC's Self-Generation Incentive Program (SGIP) provides financial incentives to support various distributed energy systems installed on the customer side of the meter. In 2008, the CPUC issued a ruling that energy storage systems meeting certain technical parameters and coupled with eligible wind and fuel cell technologies would be eligible to receive financial incentives under the program. The decision outlined operating parameters for "qualified advanced energy storage" technologies to be eligible and provided for incentive compensation on a per KW basis (California Public Utilities Commission, 2008, pp. 1, 12-13, 18). It also stated that if technologies other than wind or fuel cell were to become eligible under the SGIP program, then energy storage coupled with those systems would qualify as well (Ibid., p.7). Thus, future changes to the SGIP qualifying technologies may expand the range of energy storage devices that can benefit from the incentives. Currently, the SGIP program does not cover solar photovoltaic technologies, which instead receive financial incentives through the

³¹ San Diego Gas & Electric (SDG&E) filed its Smart Grid Deployment Plan early, on June 6, 2011. Relevant aspects of SDG&E's plan are discussed below in Section 2.1.3.6.

California Solar Initiative (CSI). The CSI, however, does not provide for separate treatment of energy storage technologies that may be coupled with distributed generation photovoltaic.

Although legislation enacted in 2009 extended the SGIP program through January 2016, it did not provide the CPUC with the ability to authorize collection of funds from the electric corporations for the SGIP program beyond the original sunset date of December 31, 2011. AB 1150 (V. Manuel Pérez, Chapter 310, Statutes of 2011), signed by Governor Brown in September 2011, authorizes funding for SGIP through 2014 and opens the program to energy storage systems. Changing the SGIP program to include energy storage will provide potentially significant incentive support to customer-side energy storage and distributed generation applications that the ARB finds will achieve overall system reductions in greenhouse gas emissions.

2.1.3.4.3 Permanent Load Shifting

A CPUC decision in 2009 ordered California's IOUs to study the means of expanding Permanent Load Shifting (PLS), defined as "when a customer moves energy usage from one time period to another on an ongoing basis," and to study the use of a standard offer program for PLS (California Public Utilities Commission, 2009c). The resulting study, published in December 2010, made a number of findings relating to PLS cost effectiveness, value propositions to the end-user, market opportunity, and best practices observed in various pilot programs nationwide. The authors used a technology neutral definition for PLS based on the impact to the electricity usage profile of routine shifting of energy usage from one time period of the day to another to help meet peak loads and improve grid operations. The study included electric energy storage, thermal energy storage, and industrial process shifting practices as within the scope of the PLS definition. It emphasized the difficulty of creating "a single, simple, technology neutral PLS program design" because of the differences between individual technologies in terms of cost, commercial readiness, and effect on the electric system. Because similar challenges exist in creating a uniform program for the deployment of energy storage technologies, the methods and several conclusions of the PLS study may have useful implications for energy storage (Energy and Environmental Economics, Inc., 2010).

In evaluating cost effectiveness of ratepayer funded PLS programs, the study used a Total Resource Cost (TRC) framework, based on avoided cost, comparing the installed costs of a PLS program with the lifecycle benefits obtained.³² The results of this evaluation suggested that PLS program design be divided into two parts: a program for mature technologies and a separate program for emerging technologies (Ibid., p.109). The goal of the mature technology program

³² For a detailed explanation of the study methodology, assumptions and sensitivity analysis, see Energy and Environmental Economics, Inc. and Strategen Consulting, 2010, Section 3.

would be to maximize the installed capacity of already cost-effective technologies that would be likely to pass the TRC test at present.³³ The goal of the emerging technology track would be to develop greater numbers of promising technologies that may be unlikely to pass the TRC test at current costs.³⁴ The design of the emerging program track would depend upon the CPUC's assessment of the usefulness of PLS to manage future load needs, such as for renewable integration, energy efficiency, and deferral of new generation capacity – needs for which many of the emerging technologies are especially well suited.

California programs such as the SGIP and CSI may serve as examples for a potential market transformation program for emerging PLS technologies. The study presents a spectrum of possible ways to structure standard offers for PLS program design. These fall along two continuum – one representing incentive level to the customer, which could range from ratepayer neutral to guaranteeing a certain internal rate of return, and the second representing the PLS program structure, which could focus on promoting on-peak energy shifting performance or on pure capacity. The authors presented several possible incentive structures and the benefits and pilot results of each, including a PLS-specific tariff, a standard offer based on performance (\$/kWh shifted), a hybrid standard offer that includes a capacity payment, and a pure capacity-based standard offer. Finally, the authors suggested characteristics of a good PLS program design based on technology data and best practices nationwide. These relate to system design and baseline technical and economic feasibility study, functional performance testing of the system once installed, and regular reporting of operational data (Energy and Environmental Economics, Inc. and Strategen Consulting, 2010, pp.109-11, 1123-16).

2.1.3.4.4 Resource Adequacy

The CPUC's Resource Adequacy (RA) program serves two purposes: (1) to ensure that California ISO has access to sufficient resources to operate the grid safely and reliably and (2) to promote the siting and construction of new resources needed for future reliability. All LSEs within the CPUC's jurisdiction, including the IOUs, energy service providers, and community choice aggregators, are subject to the determined RA requirements and must file regular compliance reports to demonstrate procurement of sufficient resources to meet their obligations. Because electric power providers can use some energy storage technologies to reduce peak power demand and to meet certain energy and capacity needs, the CPUC could promulgate rules to allow certain categories of energy storage procurement to count toward a LSE's RA obligations. This option is available for pumped storage and some types of demand

³³ The study found that well-designed, medium and large thermal storage technologies, and low-cost process shifting and pre-cooling, to be the most cost-effective at present.

³⁴ The study found that that the majority of battery storage systems providing PLS, and small-scale thermal solutions, did not pass the TRC at current operating costs.

response technologies, as described below. The CPUC and California ISO could also establish a forward market for energy storage technologies by linking projected regulation and ancillary service needs to capacity requirements for those resources. The LSEs would need to enter into procurement contracts to ensure sufficient provision of regulation services, creating an opportunity for energy storage and especially limited energy storage resources (LESRs) to secure long-term contracts for their services. Grid operators could shift excess regulation capacity to participate in the spot market.

2.1.3.4.5 Demand Response

The CPUC oversees the investor-owned utilities' administration of their demand response programs. Demand response allows end-use electricity customers to reduce their electricity usage during a given time period or shift that usage to a different time period, in response to a price signal, financial incentive, or other predetermined signal. The demand response program is important to energy storage policy in California in a few ways. First, grid operators can use energy storage technologies in demand response, especially to shift usage to off-peak hours when more supply-side resources are more cheaply available. Deployment of energy storage devices on the customer side of the meter might enable increased participation in demand response by customers whose electricity needs normally would not be compatible. As the utilities shift to a smart grid and advanced metering, localized storage might make the smart grid more flexible and responsive to generation- and demand-side needs.

Demand response might also serve as an example for energy storage of a retail program that can include participation in the wholesale market via the RA program. For example, utilities are able to count the capacity of their dispatchable demand response toward the total required capacity that they must maintain under the RA program (California Public Utilities Commission, 2010c, p.11). To maximize the value of their demand response program, a utility will try to design it so that it falls within the RA program's "counting" scheme. Energy storage policy could follow a similar trajectory so that utility investments in energy storage technologies could count toward RA requirements to the extent that the energy storage system creates avoided energy or capacity needs.

2.1.3.4.6 Alternative Fueled Vehicle Proceeding

In August 2009, the CPUC issued an OIR to Consider Alternative-fueled Vehicle Tariffs, Infrastructure and Policies, consistent with 2009 legislation directing the CPUC to "evaluate policies to develop infrastructure sufficient to overcome any barriers to the widespread deployment and use of plug-in hybrid and electric vehicles" (California Public Utilities Commission, 2009b, p.3). While the rulemaking is beyond the scope of this report, changes to facilitate growth of the plug-in hybrid and electric vehicle market and increase deployment of

electric vehicles are likely to have significant implications for the cost, development, and deployment of energy storage, especially battery storage technologies. For example, the CPUC recognizes that electric vehicle charging “could represent a new and substantial increase in load” and may require changes to electric rate design in order to ensure that increased load does not compromise grid stability or increase peak load (Ibid., p.8). Impacts on load during off-peak hours also may impact the value of energy storage applications for electric energy time-shifting and arbitrage. In addition, widespread deployment of electrified transportation has the potential to serve a variety of grid flexibility needs. Controlled charging can provide dispatchable demand and demand response at times of high variable generation output, charging rates can be designed to allow vehicle provision of contingency reserve and frequency regulation, and vehicle to grid discharge capability can serve as a source of distributed storage, should it gain public acceptance (Denholm, 2010, pp. 44-45).

2.1.3.4.7 Long Term Procurement Planning

Two aspects of the CPUC’s semi-annual Long Term Procurement Planning (LTPP) process are important to consider in relation to energy storage policy and deployment plans. One is that the LTPP is the vehicle by which the CPUC evaluates the needs of the IOUs for procurement of additional fossil-fuel or renewable generation resources and establishes rules for rate recovery. The investor-owned utilities and California ISO are cooperating with the CPUC on planning scenarios and production simulations to quantify the incremental need for flexible generation resources in the LTPP process. The CPUC has posted the preliminary results of the IOUs and California ISO, including estimated regulation and load-following needs (California Public Utilities Commission, 2011d). Stakeholders from the renewable energy and consumer and environmental protection communities also filed testimony with the CPUC on the model assumptions and planning scenarios.

Under the recently enacted legislation for 33 percent RPS by 2020, the general procurement plan process must include a renewable energy procurement plan, which will be geared toward compliance with the 2020 targets and the interim targets set by the statute. The statute also directs the CPUC to adopt criteria by which to order and select the least-cost and best-fit renewable energy resources to comply with the RPS on a total cost basis. This total cost basis includes consideration of indirect costs associated with transmission investments and operational needs for integrating eligible renewables (Senate Bill 2 [Simitian, Chapter 1, Statutes of 2011] Sec. 399.13(a)(1), (4)). Policy makers should factor the availability of energy storage technologies to mitigate some of these indirect costs associated with renewables integration into the utilities’ procurement planning and determine an acceptable level of mitigation for ratepayers.

A second aspect of the LTPP is its importance for considering and implementing the CPUC's policies around the California Energy Action Plan loading order. Many stakeholders in the energy storage proceeding under AB 2514 and in comments on this report have emphasized that inclusion of energy storage in the loading order in some manner will provide further guidance to state agencies and utilities to factor storage into long term procurement planning. The same considerations apply to including energy storage as a potential technology to satisfy Resource Adequacy requirements.

2.1.3.5 California Air Resources Board

As with the CPUC, the Air Resources Board (ARB) is engaged in a number of regulatory proceedings that will likely influence related policies on energy storage. As the lead agency implementing AB 32, the ARB has special responsibility overseeing actions to reduce greenhouse gas emissions statewide and across all sectors. The applicability of energy storage technologies to reduce greenhouse emissions in a variety of ways, from peak shaving to deferral and avoidance of new fossil fuel plant construction for peak generation, ancillary services, and renewable integration, serves as an additional reason for policy makers to consider an energy storage role.

2.1.3.5.1 ARB Cap and Trade Proposed Regulations

A carbon cap-and-trade program for California's electricity sector will increase the operating cost of fossil fuel plants that provide peak generation power, ancillary, and backup services, potentially driving down the relative cost of alternative and complementary mechanisms, including electric energy storage. As currently proposed, the regulation to Implement the California Cap-and-Trade Program will connect to the Western Climate Initiative regional trading program, will cover the major sources of greenhouse gas emissions in the state, including refineries and power plants, industrial facilities, and transportation fuels, and will depend upon an open allowance trading market (California Air Resources Board, 2010b, Part I, Vol. I). The ARB is completing its rulemaking process on schedule for a January 1, 2012 cap-and-trade program start date, although the agency has delayed emissions obligations for covered entities until 2013.

2.1.3.5.2 ARB Zero Emission Vehicle Program

The ARB's Zero Emission Vehicle (ZEV) regulations are part of its broader Low Emission Vehicle (LEV) III regulations, which together focus on reduction of smog and greenhouse gases, and on increasing penetration of battery electric, fuel cell, and plug-in hybrid electric vehicles. In 2008, the ARB adopted modifications to the ZEV regulations, triggering a review process to account for changes in the vehicle market, and to speed commercialization of zero and near-zero greenhouse gas emission producing vehicles. The regulations currently under

development will focus on incubating zero and near-zero emission plug-in hybrid and electric vehicle technology for large scale market penetration, thus complementing the CPUC's Alternative Fueled Vehicle proceeding, which relates to the regulation of ZEV charging stations and rates. Depending on the scenarios that the ARB uses to determine vehicle fleet goals for 2050, and the technologies to be promoted in those vehicles, the new regulations have the potential to jump-start additional research and incubation of advanced battery storage technologies.

Based on current Li-Ion battery technology costs, the ARB predicts that market forces alone will not be sufficient to drive penetration to the degree needed for long-term carbon emission reduction goals.³⁵ The ARB does not expect Li-Ion battery costs to become commercially competitive for ZEVs within this or even the next production generation without government incentives and/or tax credits (California Air Resources Board, 2009, p.15). In a 2009 study of the vehicle emission reductions needed to meet California's 2050 clean energy goals, the ARB noted that it can take 30-plus years for a new vehicle technology to capture a large portion of existing vehicle fleets. For example, to achieve a goal for most vehicles on the road by 2050 to be ZEVs would require immediate escalation of investments in low-carbon vehicle alternatives now, to ensure that the markets for those vehicles would develop between 2015 and 2020 (Ibid., p.10). Thus, the ARB cites the need for three types of action to attain ZEV goals: a regulatory mandate to provide some degree of certainty to investors, combined efforts of federal, state, and local governments to adopt ZEV fueling infrastructure, and consumer incentives to purchase ZEVs. The updated ZEV regulations are scheduled to be released in 2011.

2.1.3.6 Utility Investments in Energy Storage

Even prior to AB 2514, California's large investor-owned utilities have taken steps toward researching the value of energy storage and exploring which applications and types of technology would be cost effective to deploy. The value or potential value of energy storage for certain applications, as seen by the IOUs, is apparent from the numerous pilot projects and ARRA-funded storage research described in Chapter 4, as well as from the treatment of energy storage in 2010 rate case application testimony before the CPUC. The following information and quotes, taken from testimony on behalf of the utility, demonstrate the utility perspective and investments being made in storage technology.

2.1.3.6.1 Southern California Edison (SCE)

³⁵ In a May 2010 workshop, ARB staff presented current Li-Ion battery costs as hovering at \$1,000/kWh, possibly dropping to as low as \$300/kWh with high production volume. ARB. 2010. *ZEV Regulation Workshop*. May 3, 2010.

http://www.arb.ca.gov/msprog/zevprog/2011zevreg/05_03_10pres.pdf.

SCE's Project Development Division identified the need to study generation storage technologies (such as batteries and compressed air storage) (Southern California Edison, 2010a, p.10). Through rate case testimony, the utility provided several reasons for a planned 1.0 MW sodium sulfur battery energy storage system on a site adjacent to a generating station, including that the installation is needed "to enable the optimal loading of the station's existing diesel generators for the purpose of minimizing diesel engine air emissions" by providing energy storage capacity during off- peak periods and energy supply capacity during on-peak periods, and to provide additional benefits such as "improved system voltage regulation, system stability, and system reliability" (Southern California Edison, 2010b, pp.15-16). In the area of transmission and distribution technologies, SCE cited the use of energy storage systems to manage the grid and mitigate outages and service interruptions, and "to avoid the economic losses associated with catastrophic failures and wide-area blackouts" (Southern California Edison, 2010c, p.2). Similarly, the utility pointed to dynamic energy storage as providing "an important capability to support the integration of intermittent renewable energy resources" by peak-load shifting and supplying power to the grid when renewable resource generation is limited (Ibid., p.26 n.34). SCE intends to use distributed energy storage systems to stabilize variable distributed generation solar and wind resources, to meet the CPUC's policy goals under SB 17 and the Smart Grid OIR, and to enable adoption of plug-in electric vehicles. Finally, with increased variable renewable energy resources being added to the supply mix, SCE expects storage to "become a viable option to facilitate and enhance distribution grid operations" (Ibid., pp.51, 58, 56).

2.1.3.6.2 San Diego Gas and Electric (S D G and E)

Noting the significant changes in the energy system caused by advances in clean energy technologies, S D G and E consistently included energy storage as an important part of its new energy portfolio. Importantly, S D G and E is investing in energy storage systems—distributed as well as utility scale—as one component of its solution to the "intermittency issues created by the variable output of renewable energy sources" (San Diego Gas and Electric, 2010b, p.12). The utility considers distributed energy storage in particular "to be one of the key factors in enabling the proliferation of renewable resources such as wind and solar" (San Diego Gas and Electric, 2010c, p.68). In discussing the role of storage in its Smart Grid infrastructure and in solving renewable variability issues through "management and discharge of stored energy in a controlled and coordinated" manner, one S D G and E representative outlined the multiple value streams of energy storage as including power quality, power leveling and regulation on grids connected to renewable energy, peak load shifting and shaving, energy arbitrage, ancillary services related to California ISO, and T and D capacity deferral (San Diego Gas and Electric, 2010d, pp. 10, 21). Recent S D G and E rate case testimony also pointed to storage

systems as a key part of the future of its storm and outage management and its award-winning Sustainable Communities project, which encourages construction of green buildings (San Diego Gas and Electric, 2010a, p.30). Further, rate case testimony highlights that S D G and E is working with partners in the automotive sector to develop uses for energy storage systems that benefit both the transportation and home energy sectors (San Diego Gas and Electric, 2010c, pp. 56, 71).³⁶

S D G and E also has highlighted the role of energy storage in its Smart Grid Deployment Plan, filed one month early with the CPUC on June 6, 2011. Some of the ways in which S D G and E intends to use energy storage in its smart grid include: as distributed storage on circuits with a high penetration of customer photovoltaic systems; at the substation level for areas with multiple high-photovoltaic circuits; and to integrate energy efficiency, demand response, and generation into customer energy usage, including by enabling participation in existing and future energy markets (San Diego Gas and Electric, 2011b). The utility will use other pilot programs to test new or unproven technologies, including emerging storage technologies, for functionality, interoperability, and security, and to identify the most cost-effective ways to deliver needed services. Another pilot program will test new distributed energy resources, including energy storage, in a new community with residential and commercial sectors (Ibid., pp. 99, 229).

To support the penetration of intermittent power generation sources, S D G and E is supporting installation of cost-effective energy storage, either utility, customer, or third party owned, to help resolve voltage regulation, voltage flicker, and intermittency of renewable resources (San Diego Gas and Electric, 2011b, p.48). S D G and E also outlines numerous actions to support SB 17's objective to accommodate all cost-effective generation and energy storage options, such as to enable smart grid communications along distribution lines connecting distributed energy resources (DER) and energy storage providers with California ISO markets, and develop control and communications systems to facilitate aggregation of energy storage and DER, including "vehicle-to-grid" applications.

2.1.3.6.3 Pacific Gas and Electric (P G and E)

P G and E's investments in grid-scale energy storage projects, in particular its planned developments of large pumped storage, CAES, and battery facilities, suggest that P G and E recognizes the potential of various energy storage technologies and applications. P G and E has focused significant resources on the development of pumped hydro facilities. If constructed, the utility's Mokelumne Pumped Storage Project (MPSP) would provide up to 1,200 MW of

³⁶ K. Cordova, "Testimony on Customer Services—Information," San Diego Gas & Electric, pp. 56, 71.

pumped storage capability by 2020. The Department of Energy is partially funding P G and E's proposed CAES facility, contributing \$50 million to the project through ARRA (Recovery.gov, "Grants-Award Summary"). Though the project is still preliminary, P G and E began analysis on suitable geologic formations for prospective sites early this year. Analysts estimate that the project—a facility with 300 MW output capacity—will take five years to design, permit, and build (Marshall, 2009a). Meanwhile, the utility is also planning an advanced sodium-sulfur battery project to improve power quality, facilitate integration of renewable energy sources, and provide backup power to customers in case of power failure (Marshall, 2009b; California Energy Commission, 2010c). The utility received funding for this demonstration project, which was planned for a late 2010 installation in Silicon Valley, from the California Energy Commission and planned it in coordination with the Electric Power Research Institute, NGK Insulators Ltd., and S and C Electric. P G and E will add these projects to its existing storage portfolio that includes the Helms Pumped Storage Facility, a 1.2 GW hydroelectric facility near Fresno, California.

2.1.3.6.4 Municipal Utilities

Several municipal utilities similarly have energy storage investments underway. In a presentation as part of the Energy Commission's 2011 *IEPR* Committee Workshop on Energy Storage for Renewable Integration, the Sacramento Municipal Utilities District (SMUD) explained that greenhouse gas regulations, RPS-driven additions of renewable energy sources, and the need for peak load management are driving its interest in storage (Rawson, 2011). Citing both utility grid benefits and customer side benefits, the utility—which received ARRA funding for installation of two zinc-bromine flow battery systems and several different applications of lithium ion battery systems to firm renewable output, reduce peak load and cost to serve peak, and improve system reliability—acknowledged that it will need both bulk and distributed storage in the long run. SMUD is planning to demonstrate sodium nickel chloride and has begun investigation of compressed air energy storage for similar applications. In addition, SMUD is advancing the 400 MW Iowa Hill pumped storage project to further integrate variable energy resources, pending receipt of its new FERC license, favorable results from geotechnical work to verify suitability of the site to support the project, and acceptable cost/benefit assessments on the value proposition of the project to SMUD and its customers.

The Department of Water and Power for the City of Los Angeles (LADWP) also has begun to pursue energy storage options. In September 2010, LADWP announced that it will collaborate with BYD Ltd. to develop "a grid-scale battery project for renewable energy storage." The anticipated 5 to 10 MW power storage unit will be housed at the utility's Tehachapi wind farm and used for power reliability and renewable generation integration. According to the city, the

partnership “aims to test, develop and ultimately demonstrate the feasibility of large-scale energy storage options for electric utilities across the Country (City of Los Angeles, 2010).

2.1.4 Comparative Cases: Energy Storage Policy Out of State and Abroad

This section presents tariff reforms, energy storage pilot programs, and policy initiatives in other states and jurisdictions, and highlights storage-related activities in other countries. This brief summary does not represent comprehensive treatment of all storage-related policy and regulatory initiatives across the country or abroad.

2.1.4.1 Jurisdictions in the United States

2.1.4.1.1 New York Independent Service Operator (NY-ISO)

The NY-ISO created a separate resource category for energy storage devices to accommodate participation in the wholesale market. As in California’s ISO territory, NY-ISO purchases regulation services on behalf of all system users. In 2009, NY-ISO developed new market rules and software protocols to facilitate the integration of limited energy storage resources (LESRs) into New York’s regulation services market, citing multiple benefits to the grid system stemming from the ability of LESRs to respond quickly to rapid control and dispatch signals. About 80 MW of fast-response energy storage has been proposed in the form of flywheel and battery systems. The NY-ISO expects additional types of energy storage systems to join the mix, including flow batteries, fuel cells, and supercapacitors. In addition, NY-ISO views the economic potential of longer-duration energy storage systems to provide arbitrage and load-shifting, reducing the frequency of dispatch of fossil fuel peaking plants, assisting with wind energy integration and ramping, and smoothing the variability of increased wind and solar systems on a minute-by-minute and second-by-second basis (New York Independent Service Operator, 2010).

Several changes have been made to the NY-ISO market to accommodate the addition of energy storage resources. NY-ISO defined the LESR as a new class of Regulation Service provider, characterized by its ability to provide continuous, six-second changes in output and its inability to sustain operation at maximum energy withdrawal or injection for an hour (Ibid., p.10). The NY-ISO market limits devices classified as LESRs to providing only Regulation Service in the NY-ISO market. A market clearing price determines payment, as with traditional providers, but LESRs only receive payment for the net energy injected into the system, not for a “mileage payment” based on total energy the technologies withdraw or inject. And unlike traditional Regulation Service providers, for which grid operators track responsiveness to control signals and reward based on performance, the LESR currently is not subjected to performance tracking and does not receive compensation commensurate with the speed and accuracy of its response.

FERC approved NY-ISO's LESR tariff on May 15, 2009 (Federal Energy Regulatory Commission, 2009).

NY-ISO schedules LESRs based on regulation availability and "fast first," where the Automatic Generation Control (AGC) dispatches LESR prior to traditional, slower-moving generators (New York Independent Service Operator, 2010, p.11). Scheduling fast-response Regulation Service devices first increases system efficiency, improves control performance, and reduces cost. However, if the system requires regulation in a direction that the storage device cannot provide, the grid operators will dispatch LESR after all other resources (Cutter, 2009, p.9). According to NY-ISO, the Regulation Service product is the highest priced ancillary service product in New York's wholesale electricity market, creating an attractive market for additional investment in energy storage. Generally, regulation service is the most attractive product for energy storage in the ancillary services market due to its higher price, as compared to services such as spinning or non-spinning reserve (Ibid., p.2).

Building on this market opportunity, New York has committed to becoming a global leader in energy storage. The state has set aside \$25 million to finance development of energy storage and battery testing under its New York Battery and Energy Storage Technology Consortium. An additional \$15 million funds advanced vehicle components design and manufacturing, alongside an initiative to convert the state's hybrid vehicle fleet into plug-in electric (New York Independent Service Operator, 2010, pp.11-13). Like California, New York is also host to energy storage demonstration projects supported by federal funds and research at Sandia National Laboratories.

2.1.4.1.2 Midwest ISO (MISO)

Setting an example for the approach taken in NY-ISO, MISO was the first to create a separate tariff class for Storage Energy Resources (SERs), distinct from that applied to generation or demand response resources (Texas Energy Storage Alliance, 2010, Appendix A). FERC approved the tariff on December 18, 2008 (Federal Energy Regulatory Commission, 2008b). MISO then worked with stakeholders to make additional modifications to the dispatch of SERs for regulation reserve, which FERC approved on December 31, 2009.³⁷

2.1.4.1.3 Independent Service Operator – New England (NE-ISO)

In 2008, NE-ISO implemented a pilot program to incorporate 13 MW of "alternative regulation technologies," including energy storage devices and demand response. This represents 10 percent of the average hourly regulation requirements in the territory (ISO New England, 2010,

³⁷ See Federal Energy Regulatory Commission. Docket ER09-1556-000: Order Approving Multi Party Facilities Construction Agreements, December 31, 2009.

p.8). This program was the first pilot nationwide designed to include technologies not otherwise able to participate in the regulation market. The program established a range of technical specifications that it sought for participation, with a minimum of 1 MW capacity and the ability to respond within 4 seconds to AGC signals. One purpose of the pilot was to identify the preferred parameters for each participating resource, a necessary step for any ensuing changes to market and tariff structure. Under the pilot, payment for provision of regulation services is based on a “mileage” payment, or the sum of the absolute value of energy withdrawal and injection into the system. Program participants pay for the cost of interconnection and metering (ISO New England, 2010, pp. 5, 6, 12). As in NY-ISO service territory, grid operators dispatch faster resources first. A series of changes to the market rules that are compatible with energy storage and other non-traditional regulation technologies have followed the NE-ISO pilot, including a recent initiative to consider regulation service payment adjustment based on a pay-for-performance structure.

2.1.4.1.4 PJM Interconnection (PJM)

As in NE-ISO, PJM has enabled limited energy resources to participate in the regulation service market as part of an Alternative Technology Resource pilot program (See PJM Interconnection, 2010a, Sec. 3.3.1.2). As in NY-ISO, PJM established a frequency-only regulation signal, allowing fast-responding LESRs, such as flywheels and batteries, to self-manage their energy neutral base points in real-time under existing market rules. However, the current tariff compensates all regulation service providers the same, providing no additional compensation for more rapid and accurate response to control signals (PJM Interconnection, 2010b). Payment for regulation service is primarily based on foregone energy revenue opportunity cost, not on additional performance criteria. Additionally, under the current tariff, PJM has limited its definition of “energy storage resource” devices to new rapid response systems, specifically flywheels and batteries, so that treatment of the defined energy storage resource as a market seller will not cause unintended consequences, based on the lack of information about devices and technologies still likely to emerge. Thus, for the purpose of participation in the energy and ancillary service markets, flywheel, battery storage, and conventional energy storage such as pumped hydro are on equal footing (PJM Interconnection, 2010c, pp.6, 2).

In January 2011, PJM initiated a process to consider performance-based pricing that would promote more accurate regulation response and enable PJM to expand what is currently limited use of its dynamic regulation signal. This process is in the early stages and PJM has not released a timetable for the rulemaking, although it has identified key areas for activity, including defining bright-line criteria for performance requirements for incentive payment eligibility and the design of a mechanism that incentivizes accurate tracking to the regulation signals. PJM has acknowledged that the alternative resource technology investor community

perceives a misalignment of incentives in the PJM regulation market; this process aims to “properly realign these incentives to attract these new resource types, provide better operational performance and long-term cost benefits (PJM Interconnection, 2010c).

2.1.4.1.5 Texas and Electric Reliability Council of Texas (ERCOT)

In January 2011, the Public Utility Commission of Texas reported to the Texas legislature that “because some storage technologies have the capability to function as both transmission and generation, the Legislature may wish to clarify the role or roles of storage in the competitive market, whether as a regulated transmission asset, the cost of which would be recovered through regulated rates, or as a generation asset that would recover its costs in the various competitive markets” (Public Utility Commission of Texas, 2011, p.94). The Commission outlined several benefits of energy storage, including “the flexibility to adjust energy production or consumption to offset changes in wind or solar power production,” relieve transmission constraints, and assist with meeting demand during peak periods. It summarized the barriers to deployment in Texas as related to cost, lack of industry experience with energy storage and grid characteristics, and insufficient guidance for industry and regulators to define storage devices and develop operational standards and compensation (Ibid., pp.74-75).

Texas lawmakers responded with the filing of Senate Bill 943 relating to the “classification and use of energy storage equipment or facilities,” which passed the Texas legislature and was signed by the governor on June 17, 2011. SB 943 requires the utility commission to classify specific energy storage equipment or facilities as generation assets. The law also entitles facilities in this asset class to be eligible to interconnect to the grid, obtain transmission service, and sell electricity or ancillary services at wholesale. The legislature amended a previous version of the bill that had created a separate asset class for energy storage (See Texas Legislature Online, Senate Bill 943 [Carona]).

In addition, Electric Reliability Council of Texas (ERCOT) is considering similar tariff and protocol changes as described for other jurisdictions. The Texas Energy Storage Alliance industry group has recommended several changes to the regulation dispatch to take advantage of the rapid response and accuracy afforded by energy storage devices (Texas Energy Storage Alliance, 2010, p.6). Texas stakeholders have recognized the potential for energy storage to assist with rapid wind and load ramps, ancillary services, and optimizing transmission capacity and energy arbitrage (Customized Energy Solutions, 2009), due to Texas’ high wind generation output, expected to exceed 10,000 MW nameplate capacity by 2013, (Electric Reliability Council of Texas, 2010) and to their transmission limitations. ERCOT recently initiated discussion over near-term operational changes proposed by market participants to remove technical barriers to entry of storage in the energy markets (AES Energy Storage, 2011).

2.1.4.2 Foreign Jurisdictions

Many of the same interests driving energy storage domestically exist outside of the United States.

2.1.4.2.1 Germany

Germany has set ambitious national targets and implemented national policies to achieve reductions of greenhouse gas emissions from 1990 levels by 55 percent by 2030 and by 70 percent by 2040. The German government has similarly impressive targets for renewable energy production as a percentage of gross electricity consumption, committing to 35 percent renewable sources by 2020, 50 percent by 2030, and 65 percent by 2040 (Germany Federal Ministry of Economics and Technology, 2010, p.5). Germany views energy storage as integral to its national plan for deployment of intelligent smart grids and demand-side load management, to be enabled by implementation of variable electricity pricing and communication technologies, as well as to the long-term integration of variable renewables. The short-term focus is on maximizing domestically available and cost-effective pumped storage capacity; in the long-term, Germany will focus on expanding to use foreign pumped storage plants and capitalize on investments in research and development of advanced CAES, hydrogen, and battery storage. The national government has outlined policy measures to assist the expansion of Germany's energy storage capacity. These include extending exemptions from grid access charges to pumped storage and other electric storage facilities and approving energy storage systems for participation in the control energy market. To support research and development, in 2011 the German government will release plans for a "Comprehensive Energy Research Programme" through 2020 with directed funding initiatives for grids and energy storage (Ibid., pp.19, 21. 26).

The German Energy Agency (DENA) recently completed a comprehensive analysis of its electric grid modifications needed to accommodate 25 to 30 percent renewable energy resources by 2020 (Germany Energy Agency (DENA), 2010). The analysis included an examination of the costs associated with expanding transmission capacity, increased energy storage, and demand-side management measures, assuming market-driven deployment. It compared various integration solutions, using energy storage facilities to provide increased system flexibility, with the effects of other methods, such as demand-side management, improved wind forecasting, and provision of balancing energy by wind turbines or biomass plants.³⁸ DENA found that in the current regulatory and market environment, in which Germany's electricity market is economically independent from operation of the grid, "the economically optimal behavior of storage facilities on the electricity market do not necessarily result in behavior which relieves

³⁸ Ibid., p. 16.

grid bottlenecks”(Ibid., Sec. 13.1.3). Because market-driven operation of energy storage affects the flow of electricity in the grid without necessarily accounting for grid operation constraints, the use of energy storage could result in further transmission constraints and the need for additional transmission capacity. To integrate large amounts of wind energy into the grid, the German study concluded that it would be more economical – at current energy storage technology costs – to further expand the transmission grid rather than build energy storage (Ibid., Sec. 13.4.3). The study recommended that policy makers implement incentive systems in the electricity market to encourage the use of energy storage facilities in a manner that coordinates with grid operation to relieve transmission bottlenecks and lower total system costs (Ibid., Sec. 24).

The German study also found that for increased renewable integration scenarios beyond 2020, some energy storage technologies could be cost-effectively utilized for system flexibility, load smoothing/ peak shaving, and for balancing power (Germany Energy Agency (DENA), 2010, Sec. 23.6). The most cost-effective uses were for time shifting and smoothing of generated wind energy at the local level (Ibid., Sec. 23.9.5). Pumped storage represented the only option currently economically feasible for grid scale applications, but the study found that adiabatic compressed air storage and hydrogen storage comprised potentially viable, albeit high-cost, storage solutions to mitigate wind energy variability (Ibid., 22). The study determined that fast-response energy storage technologies such as flywheels and chemical batteries would be unlikely to contribute to integration of renewable energy sources due to technical limitations in their storage capacity and service life (Ibid., Sec. 22.5, 22.6).

2.1.4.2.2 China

China has no overarching policy relating to energy storage. However, multiple municipalities have implemented policies to encourage local development and deployment of storage technologies, and the national government has allocated resources to numerous demonstration projects as part of its plan for strong smart grid development in 2011-2015. Shanghai is at the forefront of this effort. In April 2010, the municipal government launched the “Development and Promotion of Smart Grid Technology” program for Shanghai, which aims to transform Shanghai into a national smart grid and energy storage research and development center. Some of the local policies include direct funding or subsidies to support development work. According to the China Energy Storage Alliance, the lack of a direct national policy supporting the development of the Chinese energy storage industry is a barrier to the establishment of a strong Chinese market for storage technologies (China Energy Storage Alliance, 2011).

2.1.4.2.3 Australia

Australia's federal government has dedicated \$100 million toward the "Smart Grid, Smart City" initiative – a commercial-scale, test business case smart grid rollout (Australian Department of the Environment, Water, Heritage and the Arts, 2009). The project identifies distributed energy storage as one of the four priority demonstrations, and several aspects of the program incorporate energy storage. For example, one Australian energy storage manufacturer implementation proposal included installation of 5 kW/ 10 kWh battery units at 60 households for such applications of peak load shifting, residential back-up, deferral of transmission upgrades, and complement to residential PV systems (China Energy Storage Alliance, 2011, p.3). In addition, the Australian Department of Resources, Energy and Tourism has a dedicated "Advanced Electricity Storage Technologies Program," which funds storage demonstration projects ranging from hydrogen-enabled solar storage to zinc-bromine flow battery (Australian Department of Resources, Energy and Tourism, Advanced Electricity Storage Program).

2.1.4.2.4 Japan

Japan's energy goals for 2030 include raising the zero-emission power source ratio from the current 34 percent to 70 percent (Japan Ministry of Economy, Trade and Industry, 2010a). Japan has established a national Renewable Portfolio Standard and is considering implementation of a Feed-in Tariff to incentivize necessary investment in renewable energy sources to meet this goal. A number of Japan's government-supported renewable energy and smart grid demonstration projects include integrated energy storage systems. In its "Demonstration of Next Generation Energy and Social Systems" program, the Ministry of Economy, Trade and Industry (METI) selected four large-scale "smart community" demonstration projects, several of which will pilot electrical battery storage technologies in conjunction with distributed renewable generation and smart grid networks (Japan Ministry of Economy, Trade and Industry, 2010b). Energy storage research and development has received significant support from Japan's New Energy and Industrial Technology Development Organization (NEDO), an administrative agency under METI that oversees multiple projects relating to grid-connected electric energy storage systems and battery systems for next-generation electric vehicles. NEDO research has developed parameters for battery storage-based voltage control and frequency balancing in conjunction with clustered and large-scale photovoltaic power generation. One purpose of this research is to enable progress toward Japan's Photovoltaic Roadmap for 2030 goals without restricting PV output (Nakama, 2010).

CHAPTER 3: Technology Gaps, Research and Development Needs, and Policy Challenges

Introduction:

The focus of this chapter is to facilitate informed decision making about the role of energy storage in California's transition to a clean energy future by providing a summary of key findings on technology and cost gaps, research and development needs from Chapter 1, and key policy barriers that remain to be addressed by the many proceedings outlined in Chapter 2. The most prominent of the policy barriers creating challenges to energy storage system deployment in California may be categorized in terms of technology cost and commercial availability, valuation and cost recovery mechanisms, and/or lack of awareness and collaboration. A recent U.S. DOE-sponsored study conducted by Sandia National Laboratory on industry needs for grid-scale storage applications categorized these challenges as "insufficient technical progress, limited demonstration and performance data, lack of standards and models, weak stakeholder understanding and support, and deficient market structure."³⁹

3.1 Technology Status Findings: Gaps and R&D Priorities

U.S. Department of Energy Advanced Research Projects Agency - Energy (ARPA-E) research has concluded that "significant advances in materials and devices are needed to realize the potential of energy storage technologies." (Nexight Group and Sandia National Laboratories, 2010a, p.1). This conclusion may be influenced by ARPA-E's objective to pursue high risk, high payoff basic science that produces order of magnitude performance increase and/or cost reduction. A related report notes that high cost, technical complexity, efficiency and lifecycle concerns render many energy storage technologies not yet commercially viable for large-scale production and grid-scale integration (Nexight Group and Sandia National Laboratories, 2010b, p.24). Although many energy storage technologies are already in commercial use or in demonstration, there continue to be challenges related to materials constraints and costs, life cycle and performance uncertainties, lack of demonstration and performance data, manufacturing requirements, and a need for superior control system and power electronics for seamless interoperability between storage devices and the grid.

³⁹ U.S. Department of Energy, Office of Electricity Delivery and Energy Reliability and Office of Energy Efficiency and Renewable Energy, Solar Technologies Program, "Electric Power Industry Needs for Grid-Scale Storage Applications," Sandia National Laboratories, December 2010, p. 23.

As demonstrated in Chapter 1, the existing limitations, opportunities, and advances are best explained in relation to each type of storage technology. However, from a policy perspective, it may be possible to address some of these limitations through changes to the regulatory structure, implementation of valuation and cost-recovery methodologies, development of uniform standards to measure key energy storage performance functions, including efficiency, capacity, and duration, and through increased funding support for focused research and development efforts. Certain storage technology costs, such as for Lithium Ion in particular, may decrease based upon increased production of battery technologies to meet growing demand for electric vehicles (Electric Power Research Institute, 2010a, p.5-2). Many industry participants acknowledge that production prices of energy storage technologies must decrease before it will be feasible to achieve significantly greater use under the current market and regulatory structures (China Energy Storage Alliance, 2011, p.2). Chapter 4 discusses a framework for California to develop a strategic vision for energy storage for 2020 and reviews funding incentives, demonstration opportunities, RD and D needs, and policy and regulatory drivers that can influence the near and long-term feasibility for increased deployment of energy storage technologies.

3.2 Policy and Regulatory Findings: Barriers and Challenges

3.2.1 Valuation and Cost Recovery

3.2.1.1 The Need for Better Valuation and Cost Recovery Mechanisms

Energy storage advocates and manufacturers frequently identify the lack of a framework to value or monetize the benefits provided by energy storage technologies, located on either side of the utility meter, as a primary barrier to energy storage deployment. This barrier falls within the “lack of standards and models” and “deficient market structures” categories listed in the Sandia/ DOE report. Yet these deficiencies are not necessarily in existence across-the-board. For example, the wholesale energy market, including regulation, capacity, and ancillary services, provides opportunities for energy storage to capitalize on already-monetized value streams. The existence of these markets, however, does not signify that barriers to participation or fair valuation for benefits provided have been addressed, as demonstrated by FERC, California ISO, and the other ISOs/RTOs’ efforts to reevaluate these market mechanisms. Even with the wholesale energy markets accessible to some energy storage technologies, California lacks a cohesive framework to evaluate costs and benefits. An example of such a framework is the *2010 Demand Response Cost Effectiveness Protocols*, which provides a standardized method to evaluate cost effectiveness of demand response programs and includes such inputs as avoided energy costs, avoided distribution costs, and avoided environmental costs for greenhouse gases (California Public Utilities Commission, 2010c).

Studies also suggest that several recognized benefits of energy storage (such as emissions reductions or certain avoided-cost benefits like transmission deferral) represent potential value streams without clear valuation mechanisms. Furthermore, cost recovery mechanisms, based upon transparently monetized value streams, are necessary for developers and system owners to realize or internalize the benefits provided. The high costs of current energy storage technologies and investment risk will persist without adoption of a valuation framework that monetizes the independent benefits and that creates opportunities for cost recovery. A key consideration is the potential market size of the recognized value streams to determine their impact on the energy storage value proposition overall, or for specific applications.

In its July 2010 white paper assessing barriers and opportunities for energy storage, the CPUC identified as a primary challenge the need to develop a tool to evaluate cost effectiveness that is technology-neutral and that evaluates the benefits and costs of a particular technology in a particular application (California Public Utilities Commission, 2010d, p.5). A critical feature of this challenge is how to allocate the costs and benefits of storage across the range of services that are affected, including generation, transmission, distribution, and regulation. In a July 2010 white paper released by UC Berkeley's Center for Law, Energy and the Environment (CLEE) and UCLA's Environmental Law Center and Emmett Center on Climate Change and the Environment (UCLA Law), the authors emphasized the need for regulatory proceedings at the state and federal level that will adopt methodologies to analyze costs and benefits and enable recapture of the values provided (UC Berkeley/UCLA Law, 2010, p.13). CLEE/UCLA Law found the lack of a formal mechanism for calculating the value of the benefits and resource savings brought by energy storage to be a primary barrier to wider implementation of storage in California. Without such a mechanism, current pricing of electric energy and services does not enable storage owners to internalize or realize most of energy storage resource benefits (See Eyer, 2010, p.xvi). As the CPUC contemplates a cost-benefit methodology for electric energy storage and potential cost-recovery mechanisms and ownership models across the range of service applications, the input provided by a number of industry, utility, and government-sponsored studies is critical.

Although selecting or developing a valuation methodology is beyond the scope of this report, a brief review of the approaches taken in other studies may assist the CPUC and the Energy Commission in their efforts to create a valuation structure for energy storage technologies.

3.2.1.2 Approaches to Valuating Benefits and Determining Cost Effectiveness

In February 2010, the U.S. Department of Energy sponsored an analytical effort to develop a high-level, technology-neutral framework for assessing the benefits and market potential for energy storage in the electric grid. The theme driving the resulting "Benefits and Market Guide" is the potential to aggregate the various, complementary benefits offered by energy storage to

create attractive value propositions for the market and for industry (Eyer, 2010, p.xv). The guide also recognizes that some benefits may not be aggregated, due to institutional barriers or technical/operational conflicts. The guide's framework is useful to this analysis insofar as it characterizes 26 benefits associated with the use of energy storage for electric utility applications, as well as the financial value, market potential, and estimated economic impact for various applications.⁴⁰ It provides eight examples of potentially cost-effective value propositions, such as "electric energy time-shift plus transmission and distribution upgrade deferral," or "renewables energy time-shift plus electric energy time-shift plus electric supply reserve capacity." The value of individual benefits depends upon a number of assumptions relating to duration discharge, power rating, financial criteria, and market potential, and may be meaningless if the stakeholder cannot internalize the benefit. Finally, any particular benefit is application specific. The guide categorizes 17 electric grid related applications for energy storage into five categories: (1) electric supply, (2) ancillary services, (3) grid system, (4) end-user/ utility-customer, and (5) renewables integration (Eyer, 2010, p.21).⁴¹ It suggests that lawmakers and regulators recognize a societal storage value proposition that values the benefits that may accrue to utility customers as a group or to society at large and may be complementary to value propositions that directly benefit the individual owner/user of a storage system (Ibid., pp.134-35).

EPRI also rendered a valuation framework that identifies ten, key near-term applications for energy storage across the electrical system and evaluates discrete benefits that can be aggregated across those categories. The ten categories of near-term applications are: (1) wholesale market, (2) renewables integration, (3)/(4) stationary and transportable storage for T and D, (5) distributed energy storage, (6) residential customer aggregated systems, (7)/(8) commercial/industrial power quality, reliability, and energy management, and (9)/(10) home energy backup and management (Electric Power Research Institute. 2010a, p.ES-9).

Many energy storage technology developers take a similar approach to EPRI. In its comments to the CPUC under AB 2514, the California Energy Storage Alliance (CESA) suggested that the

⁴⁰ The Guide's authors take care to distinguish a *benefit*, which connotes a value that may be monetized, or may be qualitative in nature, from an *application*, which connotes a particular use. (Eyer, 2010, p. 2 (¶ 1.4.1)).

⁴¹ The 17 applications are grouped as follows: (1) Electric supply (electric-energy time shift, electric supply capacity); (2) Ancillary services (load following, area regulation, electric supply reserve capacity, voltage support); (3) Grid system (transmission support, transmission congestion relief, T&D upgrade deferral, substation on-site power); (4) End-user/Utility-customer (TOU energy cost management, demand charge management, electric service reliability, electric service power quality); (5) Renewables Integration (renewables energy time-shift, renewables capacity firming, wind generation grid integration).

CPUC may need to consider different methodologies to evaluate costs and benefits for energy storage depending on the application, especially for bulk versus distributed applications, since one serves primarily at the transmission level and one at the distribution or customer level (California Public Utilities Commission, Docket R10-12-007, Comments of the California Energy Storage Alliance, p.8). CESA also emphasized the need for the CPUC to develop a methodology to create a Resource Adequacy (RA) value for energy storage technologies not presently counted under the program. Some additional (though not all) stakeholders shared this view and suggested that the CPUC should address RA value in a separate proceeding from the AB 2514 rulemaking. With respect to developing a cost-benefit methodology, the Western Power Trading Forum, with membership of numerous energy service providers and investment firms, suggests that the determination of storage application costs and benefits should be determined by the end-user market based upon cost and potential application information that is made available through the CPUC's proceeding (Ibid., Comments of the Western Power Trading Forum).⁴²

Southern California Edison (SCE), in its effort to build upon the work of Sandia, EPRI, and others and to create a practical cost-effectiveness and valuation methodology from the utility perspective, also decided upon an "application-focused valuation methodology" (SCE White Paper, 2010, p.4).⁴³ SCE first identified discrete operational uses with independent values or benefit streams for energy storage and "bundled" the potential operational uses into applications, based on both location and operating profile. SCE then matched these applications with best-fit technology choices and assessed the pairings from an economic and feasibility standpoint, using a variety of 2020 scenarios.

SCE noted that the utility of its valuation and application-technology pairings is limited by ongoing regulatory uncertainty, especially concerning cost recovery mechanisms and asset classification (SCE White Paper, 2010, p.63). For each discrete operational use that SCE identifies, it includes a short list of value metric uncertainties that exacerbate the difficulties of valuation (See *ibid.*, p. 24, Fig. 3). EPRI's valuation analysis also recognizes that policy action on several fronts, including definition of ownership structures and business models that account for storage flexibility, rules regarding allocation of storage system costs, and tariff and metering structures that accommodate the unique bi-directional nature of storage, is required to realize

⁴² Western Power Trading Forum describes itself as a "broad-based membership organization dedicated to encouraging competition in Western states electric markets" and is primarily concerned with the long-run cost of electricity to consumers and with maintaining system reliability. See <http://www.wptf.org/>.

⁴³ Rittershausen and McDonagh, "Moving Energy Storage from Concept to Reality: Southern California Edison's Approach to Evaluating Energy Storage," Southern California Edison, 2010.

the full benefits of energy storage assets (Electric Power Research Institute, 2010a, pp.5-7). The Sandia report similarly lists a number of important challenges that affect potentially attractive value propositions, ranging from the high installed cost per kW of energy storage to the limited mechanisms available for sharing of risk and reward/benefit (Eyer, 2010, p.139). Chapter 5 will review potential solutions to these challenges in more detail.

Another approach to valuation would be to follow the avoided cost model used for qualifying facilities (QFs) under the Public Utility Regulatory Policies Act of 1978 (PURPA).⁴⁴ Under PURPA, a regulated utility is required to buy power from QFs that can produce power for less than the utility's "avoided cost," or the cost to the utility to generate or procure the power itself. In California, avoided cost is generally based on the cost of natural gas, since it is presumed to be the fuel that would be used in the marginal generating unit. As with many renewable generation sources today, applying the same approach to storage might not provide sufficient revenue to make most or all storage technologies marketable, based on the relatively low cost of natural gas and the failure of the avoided cost approach to consider the values attached to storage that go beyond the avoidance of buying a unit of natural gas.

The determination of a valuation methodology requires significant analysis beyond the scope of this report and likely will receive extensive treatment in the CPUC's AB 2514 rulemaking. Generally, the value of energy storage technologies vary depending on the technology, location, and the market value of services they provide. Policy makers will need to devise a framework that addresses the multiple values and potential overlapping nature of energy storage's benefits. They might consider studying how the various analytical approaches mentioned above would value the same energy storage projects under the same operating and market conditions to compare and identify improvements for each approach. And if the CPCU decides to set a broad mandate for energy storage according to a total optimal deployment figure, as AB 2514 allows, the agency could use further valuation work to inform the setting of that figure.

3.2.1.3 Important Considerations for a Valuation Framework

The CPUC has determined to proceed with a two-phase rulemaking process under AB 2514. In Phase 1, the CPUC will develop policies and guidelines for energy storage based upon current uses for storage and potential deployment schemes that can maximize grid and environmental benefits. This Phase will provide the Commissioners and participating parties with the requisite information about storage technologies, system benefits, and barriers to deployment. Phase 2, which will address energy storage application values, costs, and means to determining cost

⁴⁴ Energy Commission Chairman Weisenmiller raised the question whether energy storage systems should be valued based on avoided cost at the 2011 IEPR Committee Workshop on Energy Storage on April 28, 2011 (See California Energy Commission, 2011b, p. 42).

effectiveness, will lay the foundation for a decision on the viability and cost effectiveness of procurement targets. The CPUC rulemaking ultimately should resolve many of the uncertainties relating to valuation and cost recovery, providing a means for energy storage system developers, owners, and users to predict and realize more of the value of benefits provided by their system.

Considerations that the CPUC will need to address include:

- How to group operational uses and associated benefits, such as by application(s) and location.
- Whether to prioritize certain applications to meet the objectives set forth by AB 2514.
- Whether procurement targets, if adopted, can help resolve technology cost and performance challenges given current market and regulatory structures.
- Whether to pursue integrating energy storage into California's loading order and the CPUC's RA and LTPP processes.
- How increased energy storage deployment might impact other policy priorities, including flexible demand/demand response, distributed generation, and electric vehicle charging.
- How to compensate energy storage owners/ operators for services not covered by California ISO markets. An example would be the use of performance-based contracts for storage systems installed on the distribution grid that may defer transformer upgrades, reduce voltage flicker caused by photovoltaic generation, and frequency regulation and grid stabilization.
- A methodology to determine which services/applications and related value streams may be aggregated to maximize financial return to a storage system without double-counting benefits or committing the same resource to incompatible uses at one time.

In discussing the approach of "stacking" or aggregating energy storage benefits, several studies have noted that the value of energy storage may only justify deployment when operation of the device allows it to take advantage of more than one individual source of revenue by combining services (Denholm, 2010, p.11). It should be noted that these services, which the CPUC categorizes as economic and operational, are not mutually exclusive and will overlap (California Public Utilities Commission, 2010d, p.5 fn12). Sandia National Laboratories provides a detailed explanation of the challenges that accompany aggregating benefits, including the issue of overlap and the potential for technical and operational conflicts between multiple applications. Their work cites the difficulty of aggregating benefits that accrue to different stakeholders as one of the primary challenges faced by otherwise financially viable value propositions (Eyer, 2010, pp.123-24). The Public Utility Commission of Texas identified the challenges associated with storage serving multiple roles or functions at the same time as

“cross-subsidization, competition, and discrimination.” (Public Utility Commission of Texas, 2011, p.74).

Stakeholders to the AB 2514 process have weighed in on this issue. Some emphasize that the valuation process should quantify ancillary service benefits and environmental quality benefits to ensure that the complexity of energy storage does not undermine its fair comparison to other emissions and energy reduction strategies (See California Public Utilities Commission, Docket R10-12-007, Comments of Environmental Defense Fund; California Energy Storage Alliance). This effort might create a quantifiable benefit that can be stacked alongside the traditionally monetized value streams, increasing the overall value proposition for energy storage. Others argue that stacking benefits or quantifying environmental or ancillary benefits may lead to inflated estimates of the value of storage if non-mutually exclusive categories are treated as additive (Ibid., Comments of Calpine Corp.).

Thus, a valuation methodology for energy storage will need to delineate which categories of uses or applications may or may not be aggregated, as well as how to allocate costs and resulting benefits, in part based upon the ownership or business model(s) utilized (Electric Power Research Institute, 2010a, pp.5-9; Eyer, 2010, p.139). A valuation method must coincide with the establishment of cost recovery mechanisms that are sufficiently reliable and long-term technologies which may require years to provide a return on capital investments can receive financing. In Chapter 5, this report provides several examples of promising applications for energy storage and suggestions for viable cost-recovery and policy or regulatory changes that might increase the value and viability of storage technologies.

3.2.2 Awareness and Collaboration

Several reports have cited a lack of stakeholder awareness of energy storage benefits, as well as a lack of coordination and collaboration amongst stakeholders and at the inter- and intra-agency level, as key barriers to transforming and modernizing the grid using energy storage technologies. The Sandia report identified “limited familiarity, knowledge, and experience base” with storage technologies, benefits, and system integration as one of the many challenges that must be overcome by energy storage proponents (Eyer, 2010, Appendix G-2). Another Sandia/U.S. DOE report stated that a lack of understanding by much of the electric power industry of the value and applications to which storage technologies may be applied, contributing to a dearth of grid-level demonstration projects that are necessary to validate the benefits and obtain industry and public buy-in (Nexight Group and Sandia National Laboratories, 2010b, pp.24-25). Without sufficient proof that a given business model and technology combination can capture diffuse revenue streams, modernize the grid, and reduce greenhouse gas emissions, regulators are unlikely to take the time to consider classifying storage within the generation or distribution market structure or pursuing other methods to

deploy storage. The CLEE/UCLA Law white paper similarly identified a lack of awareness of energy storage benefits as one of three primary barriers to expanding energy storage in California (UC Berkeley/UCLA Law, 2010, p.3).

The passage of AB 2514 and the increased focus of California lawmakers and energy agencies on examining the costs and benefits of energy storage may have jumpstarted a process that counters the lack of awareness reported above. The CPUC rulemaking under AB 2514 and the Energy Commission's 2011 IEPR workshops have generated a substantial response from the regulated community, industry, and environmental and consumer groups. While these processes may serve to increase awareness of applications for and the benefits of energy storage, they do not dispel the need for increased coordination and collaboration around study efforts, performance data sharing, and the development of consistent standards for testing protocols and storage interconnection and communication. Nationally, the Sandia/ DOE report suggests that the Department sponsor a clearinghouse of energy storage to "serve as an authoritative source for the current status of energy storage research and commercialization (Nexight Group and Sandia National Laboratories, 2010b, p30). The clearinghouse would comprise an up-to-date database of pending and completed storage installations and demonstration projects, application needs, and technology specifications. It could facilitate national and state regulatory efforts to evaluate the need for and benefits of energy storage, and assist technology developers in meeting ascertained needs and specifications.

3.2.3 Competing Policy Priorities

An additional consideration and potential barrier to increased deployment of energy storage technologies is that of competing policy priorities. Several stakeholders to this report's development, as well as to the 2011 IEPR and AB 2414 processes, have raised the question whether a zealous drive to implement energy storage technologies may detract from or directly interfere with other competing policy priorities, such as flexible demand/demand response, low-cost electric vehicle charging at off-peak hours, and low electricity prices for ratepayers. Most of these concerns center on energy storage technology's cost, specifically whether an energy storage procurement mandate would force the adoption of more expensive technologies over other technologies or grid solutions that would cost ratepayers less.

As an example of a competing alternative, GE announced in May 2011 the commercial availability of a 510 MW combined cycle, gas turbine with base-load efficiency of 61percent to ramp up and down at a rate of 51 MW/minute to adjust to wind and solar resources (Shakhtur, 2011). Although the load balancing is done with a fossil fuel, this innovation is significant in terms of capabilities of modulating large solar and wind ramp rates. GE is introducing its first units in Europe, China, India and Brazil, while the company waits to see what U.S. policy will be on renewables and climate change. The one noted U.S. exception is California due to its

33percent Renewable Portfolio Standard (RPS). San Diego Gas and Electric (S D G and E) on May 23, 2011 filed for regulatory approval of 450 MW of GT peaker plants under a power purchase agreement for precisely the purpose of rapid ramping for wind and solar variability (San Diego Gas and Electric, 2011a).

The California ISO, in its "Summary of Preliminary Results of 33percent Renewable Integration Study -2010 CPUC LTPP Docket No. R.10-05-006," does not call for energy storage to be among the grid tools necessary to manage the system to meet the 33percent renewable goal (California ISO. 2011a). While the study does not indicate that the California ISO would not use energy storage if available as a viable resource, it does make the analytical case that storage would not be necessary. The California ISO acknowledges that energy storage is a possible viable resource, however, and recommends "running additional sensitivities to additional evaluation [using] storage, pump hydro and demand response." As a result, various Smart Grid technologies and the high-efficiency, simple-cycle gas turbines will present compelling alternatives to utility-scale energy storage in the near term.

Despite the existence of these alternatives, many policies related to them are complementary, although they may involve tradeoffs (See California Energy Commission. 2011b, pp. 40-42). The subject is closely linked to the need for a transparent valuation methodology, discussed above, which would provide a fair basis for comparing the costs and benefits of energy storage against other technologies or operational solutions to meet the same grid needs. With proper valuation and price signals, the consumer market may attain some equilibrium based on response to properly-valued price signals (Ibid., p.41).

Since AB 2514 directs the CPUC to base its energy storage determinations on both viability and cost effectiveness, price signals that emerge from the CPUC rulemakings must use a similar metric for competing solutions. This comparison feature also relates to the need to evaluate energy storage costs and benefits at the application level, since the value proposition for the same technology might vary depending on which application(s) it serves and whether the same range of applications can be served by the competition. Finally, it presents the CPUC and Energy Commission with further reason to evaluate whether policy makers should integrate energy storage into California's loading order. This integration could clarify the state's policy priorities regarding which technologies should be sought first or whether several potential solutions should be placed on equal footing in the loading order to allow market forces to determine the ultimate mix of solutions. The CPUC and Energy Commission should evaluate the risk that promoting energy storage may increase costs to ratepayers or skew a fair comparison with competing solutions, as they simultaneously analyze the numerous ways in which energy storage technologies help the state meet its energy and environmental goals.

CHAPTER 4: Applications and Scenarios Analyses for Energy Storage in California – Background, Purpose, and Approach

Introduction:

As discussed in Chapter 2, California’s energy agencies and the legislature have committed to examining the benefits of increased deployment of energy storage in California. AB 2514 allows the CPUC to set broad targets for energy storage procurement (and also allows the agency to decline to set targets) but emphasizes that any such targets must be consistent with technological viability and cost effectiveness. For the CPUC to determine appropriate targets, if any, as a means to increase energy storage deployment, it must decide upon a basic framework with which to analyze the costs and benefits of and various possibilities for target development. Through the 2011 *IEPR* process, the Energy Commission similarly must identify a framework to evaluate the possible roles for energy storage in California, develop a strategic vision for deployment, and identify the policy and regulatory needs to achieve the execution of such a vision. These agency processes should take into account the results of ongoing research by the California ISO and others on the changes needed to maintain a reliable and stable electric grid as the state moves toward its 2020 energy goals and beyond.

The remaining sections of this Chapter set forth three important elements to be considered in the course of developing a vision for energy storage in California for 2020. These are:

- California’s grid needs and applications
- Possible policy, regulatory, and market-based drivers
- An analytical framework to assess the costs and benefits of storage deployment and to prioritize applications and technology areas for further study or incentive development.

These elements will serve as the basis for an overarching framework by which to analyze various scenarios for energy storage deployment in California. Two important considerations underlie this effort. First, the California Legislature has directed the CPUC to develop targets, if any, for the deployment of energy storage in California. Although whether and in what form the CPUC may elect to set targets remains undetermined, targets under AB 2514 are a likely driver for energy storage technologies. Second, no framework can be effective without an implementation strategy that, in the case of increasing deployment of energy storage, includes a cost-benefit valuation methodology and long-term, dependable cost-recovery mechanisms for storage owners, users, and investors.

4.1 California's Grid Needs and Applications Selection

This report offers three categories of grid applications to serve as a basis for analyzing the technical and economic feasibility of energy storage solutions in California by 2020. The three exemplary application categories are:

- Frequency Regulation,
- Renewables Grid Integration, and
- Community Energy Storage / Distributed Energy Storage Systems.

These grid application categories are intended to serve only as representative use cases for energy storage deployment. They encompass more specific applications and operational uses that several recent studies and workshops suggest to be strong. A report resulting from a two-day stakeholder workshop sponsored by the DOE and organized by Sandia National Laboratories found that these five applications have “the greatest overall potential to benefit power system planning and operations” (Nexight Group and Sandia National Laboratories, 2010b, p.16). However, these applications do not encompass all of the possible applications for energy storage, nor does their selection imply that they are the “best” or even the “priority” applications for California. Their use in this report is intended to be exemplary in nature and to highlight the bandwidth of potential value that might be derived from energy storage technologies in meeting the anticipated needs of the grid for 2020. These applications correspond with several more specific applications identified by industry groups such as CESA and analyzed in studies by EPRI, (See Electric Power Research Institute, 2010a), Southern California Edison, (See SCE White Paper, 2010) Sandia National Laboratories on behalf of the DOE, (See Eyer, 2010), and NREL (See Denholm, P, 2010).⁴⁵

The decision to use three exemplary applications rather than prioritize the “best” applications stems from the timing of this report, which will be completed prior to several significant studies on California's grid needs for 2020. Policy makers should look to these sources as they are published for the most useful information regarding anticipated grid needs to meet the 33 percent RPS by 2020 goal. Although preliminary data are available, they generally do not account for energy storage needs or impacts.

For example, in May 2011, the California ISO released a *Summary of Preliminary Results of 33percent Renewable Integration Study* as directed by the CPUC for the 2010 long term

⁴⁵ These studies present a variety of ways in which energy storage applications or operational uses can be categorized and provide important baseline information for the feasibility of assigning storage to these applications. This report will draw on that baseline information in the *Applications and Scenarios Analysis*, Chapter 11. See Appendix A of that report for a side-by-side comparison of the different application categories identified in these studies.

procurement planning process. The summary presents preliminary findings regarding the operational requirements for renewable integration in such areas as regulation up and down and load following, under several different scenarios and based upon key underlying assumptions. Based on the assumption that California achieves its demand side objectives for the time period, the preliminary results suggest that “most operational requirements can be satisfied with potential need for measures to address over-generation conditions” (California Independent System Operator, 2011a, Slide 51). California ISO’s preliminary conclusion is that based upon current load projections, demand-side management, assumptions for wind and solar forecast error, and the expected mix of renewable generation sources and retirement of sources, meeting California’s load and regulation requirements can be achieved without the need for a significant amount of additional resources.

California ISO recommends updating the analysis in future years as assumptions evolve, specifically to continue to refine forecast error assumptions using actual data. The ISO also recommends running additional sensitivities to: (a) assess higher loads, (b) assess changes to forecast error and requirements, (c) evaluate generation outages, (d) assess resources needed for local capacity requirements, (e) further evaluate storage, pumped hydro, and demand response, and (f) assess different assumptions of dynamic transfers (California Independent System Operator, 2011a, Slide 52). These additional factors, as well as other considerations such as the environmental and greenhouse gas emission impacts of utilizing existing resources to achieve the load-balancing for the future grid, must be weighed alongside California ISO’s preliminary findings. For example, a study released by the California Council on Science and Technology found that if electric generation in 2050 is predominantly based on renewable intermittent resources, firming by natural gas turbines would likely result in emissions that alone would exceed California’s 2050 targets (California Council on Science and Technology, 2011, p.4). Thus, it will be critical for California to develop its zero-emission load balancing technologies concurrent with renewable resource development.

Although California ISO’s preliminary results do not address the role of energy storage in meeting the projected grid needs, the grid in 2020 will require regulation and load-following resources and may require resources that can serve as a load sink at times of renewable over-generation. The remainder of this chapter will (1) outline possible drivers to support the development and deployment of energy storage devices for those roles, and (2) define the framework for an application and scenario-based approach to evaluating the value and feasibility of storage and to discerning the potential economic and environmental impacts.

4.2 Possible Drivers for Energy Storage Deployment in California

Policy makers should base the identification of targets, milestones, and actions necessary for the development and deployment of energy storage technologies in California on a basic menu of possible drivers. These drivers, policy and market-based, can be grouped into five general areas:

- Targets/ mandates,
- Tariff/ market reform,
- Adjustments to loading order / resource adequacy rules,
- Financial incentives, and
- Funds for R and D.

4.2.1 Procurement Targets

If promulgated under AB 2514, energy storage procurement targets for load-serving entities (LSEs) would constitute the most direct path to increased deployment of energy storage in California. As with the RPS, energy storage procurement targets would require the state's utilities to incorporate storage into their procurement of resources to meet a variety of needs specified in the statute. The targets and any complementary policies to "encourage the cost-effective deployment of energy storage systems, including refinement of existing procurement methods to properly value energy storage systems" must be "technologically viable and cost effective" (Assembly Bill 2514 [Skinner, Chapter 469, Statutes 2010], Sec. 2837, 2836.2(d)). The targets would be mandatory; AB 2514 provides dates by which the utilities would have to achieve the targets and sets out a framework for demonstrating compliance (see *ibid.*, Sec. 2837, 2838).

The notion of energy storage target-setting has sparked significant controversy. Some energy industry stakeholders question the effectiveness of procurement targets that may act as a form of "subsidy" and compete with other potentially lower-cost services, such as demand response, or risk interference with other policy priorities, such as low-cost, off-peak charging for the burgeoning electric vehicle market. Other stakeholders believe that targets should not be necessary and that energy storage technologies should compete with other options for addressing identified grid needs in the most cost-effective manner. A few energy storage advocates, however, note that a broad-based target set in megawatts or percentages would be less complicated than a more detailed, application-based approach and would allow the most cost-competitive and feasible technologies to secure contracts under the broad mandate. While AB 2514 empowers the CPUC to make the final decision on targets, this report seeks to inform that decision by highlighting the potential benefits and concerns associated with the various options available to policy makers.

AB 2514 provides the CPUC with significant discretion in terms of the form of the targets, if any. It does not specify that the targets be in percentages or megawatts, nor does it indicate a preference for a single mandate (for example, 5percent of peak load) or more nuanced targets that could be application- or location-specific (for example, 5percent of load-following capacity, or 50 MW of customer-side-of-the-meter storage, 100 MW of utility-side-of-the-meter). The application and scenario-based assessment to follow will consider the possible impact of various forms of targets on energy storage deployment, feasibility, and cost effectiveness, as well as possible implications of targets for other policy priorities.

4.2.2 Tariff and Market Reform

Tariff and market reform as a policy driver may complement procurement targets or may serve as an alternate mechanism, in lieu of a regulatory mandate. Chapter 2 provided a detailed overview of multiple processes underway at FERC and at California ISO to remove barriers and encourage participation in the electricity markets by energy storage technologies. Most significant at the state level are California ISO's modifications to the ancillary services market rules and implementation of Regulation Energy Management. The California ISO could also implement shorter market intervals, which would allow more energy storage technologies to be competitive, as the entity is now considering. These processes could remove barriers to participation for fast-responding energy storage resources that could address the state's environmental and energy needs in a cost-effective manner. At the federal level, FERC is reviewing measures for frequency regulation compensation in the wholesale power market and is considering whether to classify energy storage technologies so as to allow cost recovery as a generation or transmission/distribution resource, or potentially as both, or as a separate asset.

Each of these processes is significant for its potential impact on cost-recovery, and thus on the economic feasibility of increased energy storage deployment. For example, a decision by FERC to allow energy storage systems to serve at times transmission functions would allow the storage system to recover some cost in FERC-approved transmission rates. A decision to classify energy storage technologies as a separate asset class would most likely shift jurisdiction over the development of a cost-recovery mechanism to the states. A decision to direct implementation of a "mileage payment" in frequency regulation compensation by the ISOs and RTOs would increase the attractiveness for storage participation in that market, as would shorter market intervals.

Other mechanisms that might be considered by the CPUC include retail electricity pricing that reflects real-time prices or extends time-of-use (TOU) pricing and/or energy and demand charges beyond certain commercial and industrial users. The CPUC Policy and Planning Division suggested in its 2010 white paper on energy storage that dynamic rates create energy arbitrage opportunities for customers, and that those customers subject to energy and demand

charges would be able to reduce their maximum demand peak with energy storage, saving on demand charge costs. The white paper recommended that the CPUC require that all IOU customers move to dynamic retail rates to incentivize more efficient use of power (California Public Utilities Commission. 2010d, pp.6, 9).⁴⁶

Several stakeholders to the AB 2514 and 2011 *IEPR* process have stated that real-time/ TOU pricing and variable pricing for fixed transmission and distribution costs are essential to enabling deployment of cost-effective energy storage for such applications as peak-shaving and load-shifting. Without visible forward pricing, energy storage operators will have to estimate when the largest price differentials occur between buying low and selling high, leading potentially to less efficient use of the resource. To the extent that these pricing changes provide incentives for retail or behind-the-meter storage, some stakeholders prefer that the customers who benefit from reduced electric bills shoulder the cost of storage, rather than all ratepayers. Stakeholders also criticize what they point to as a trend of the past decade at the CPUC to approve tariffs that reduce the KWh cost difference between on and off peak, narrowing rather than expanding the cost-value gap for storage options (See Schüss, 2011, p.12).⁴⁷ Others argue that dynamic pricing for residential and small business ratepayers falls outside the scope of the AB 2514 proceeding and has little bearing on grid scale energy storage (See, example given, California Public Utilities Commission, Docket R10-12-007, Comments of the Division of Ratepayer Advocates). Still others argue that market rules should allow all grid assets, including energy storage, to compete for wholesale prices that reflect actual grid conditions as an approach to ensuring cost effectiveness.

4.2.3 Loading Order and Resource Adequacy Requirements

California's loading order and the CPUC's Resource Adequacy (RA) program constitute two other areas which could be modified to facilitate adoption of energy storage technologies, although some stakeholders express the belief that inclusion in the loading order may not yield tangible benefits for energy storage. In its 2010 white paper on energy storage, the CPUC Policy and Planning Division identified both of these areas as ripe for consideration in a CPUC rulemaking.

⁴⁶ The CPUC also points out that state law limits how soon the CPUC can implement default dynamic rates for residential customers to January 1, 2013 at the earliest (California Public Utilities Commission. 2010d, p. 9, fn. 19).

⁴⁷ See Schüss, Klaus, "Energy Storage for Renewable Integration: Comments to IEPR Workshop of April 28, 2011," KSEngineers, <http://www.energy.ca.gov/2011_energypolicy/documents/2011-04-28_workshop/comments/TN_60630_04-28-11_KSEngineers_Comments_on_the_April_28_2011_IEPR_Works.pdf>, p.12.

As discussed in Chapter 2, the loading order for electricity resources consists of first decreasing electricity demand through energy efficiency and demand response, and second utilizing renewable energy and distributed generation resources, then clean fossil-fuel generation, to meet new generation needs in a cost-effective manner (California Energy Commission, 2005a, p.E-1). Through several Energy Action Plans (EAPs) and Energy Commission *IEPRs*, the loading order has served as the basis for recommended energy policies and decisions. Express inclusion of electric energy storage in the loading order would demonstrate the importance of energy storage as a component of meeting California's electricity needs. For example, if the state energy agencies inserted "electric energy storage resources" before "clean fossil fuel generation," they would send a clear message that state policy prefers the use of clean energy storage before adding additional fossil-fuel generation. Policy makers could also include "electric energy storage" dedicated to shaving peak load with "demand response." These policies could benefit energy storage deployment by encouraging decision-makers to examine thoroughly the costs and benefits of a particular energy storage technology competing for a contract.

The RA program exists to ensure that sufficient resources are available for California ISO to maintain safe and reliable operation of the grid in real time, and to provide appropriate incentives for the siting and construction of new resources needed to maintain future reliability. The CPUC enforces RA requirements through required monthly filings by LSEs to demonstrate sufficient procurement to meet its total load forecast plus 15 percent reserve, and through annual RA proceedings to review and refine the program. Under AB 2514, energy storage "may be used to meet the resource adequacy requirements established for a load-serving entity pursuant to [Public Utilities Code] Section 380 if it meets applicable standards" (Assembly Bill 2514 [Skinner, Chapter 469, Statutes 2010], Sec. 2836.4(a)). One stakeholder to the AB 2514 proceeding points out that, given this statutory provision, "determining precisely how LSEs may gain RA credit for [electric energy storage] investments seems to be a productive effort for the Commission to engage in to further the attractiveness of [electric energy storage] investments" (California Public Utilities Commission, Docket R10-12-007, Comments of Western Power Trading Forum). Thus, the CPUC may need to develop a methodology to determine a RA value for applicable energy storage technologies, and refine its standards for the program, for more energy storage systems to qualify (California Public Utilities Commission, 2010d, p.8). If the CPUC takes these steps, both IOUs and POU's will have additional incentive to include more energy storage in their resource procurement strategies.

4.2.4 Financial Incentives

Several types of government-sponsored financial incentives may be extended or expanded to drive energy storage development and deployment. These include: loan guarantees, tax credits,

cash grants, and state incentive programs such as the Self-Generation Incentive Program (SGIP) and California Solar Initiative (CSI). As with procurement targets, some stakeholders criticize these types of incentives as “subsidies” that skew the market and conflict with other policy priorities. Other stakeholders want to ensure that any proposed tax incentives are not subject to frequent legislative renewal that could inject significant uncertainty and discourage investment.

4.2.4.1 Federal Programs

Currently, federal support of renewable energy investments may occur via the renewable energy production tax credit (PTC), the federal business investment tax credit (ITC), the § 1603 cash grant in-lieu of tax credit, the manufacturing investment tax credit, and the new Clean Renewable Energy Bond (CREB) and Qualified Energy Conservation Bond (QECB) programs. A brief description of each program follows. At this time, none of these provide support for electric energy storage technologies. The lack of programmatic support thru tax credits is the reason for the reliance by energy storage developers and investors on either DOE funding, discussed below, or on private investment.

4.2.4.1.1 Production Tax Credit

A Production Tax Credit (PTC) is available to renewable energy producers such as wind, biomass, geothermal, small irrigation power, municipal solid waste, hydropower, and marine and hydrokinetic, the PTC spreads credit over a ten year period based on a formula of cents per kilowatt hour of electricity produced by the facility. (Internal Revenue Code, 26 U.S.C. Sec. 45). The American Recovery and Reinvestment Act (Recovery Act) extended PTC availability for certain facilities placed in service by January 2013, and for other placed in service before January 2014. The PTC is unlikely to apply to energy storage based on the requirement that the electricity credited be “produced by” the taxpayer, suggesting a pure generation function. (See *ibid.*, 26 U.S.C. § 45(a)(2)(A)).

4.2.4.1.2 Investment Tax Credit

An Investment Tax Credit (ITC) allows a qualifying facility to collect a single federal income tax credit against its tax basis equal to 30 percent of its cost, usually claimed when the facility is placed into service. (Internal Revenue Code, 26 U.S.C. Sec. 48). Qualifying facilities include those that provide on-site and distributed generation, including fuel cell, solar, limited geothermal, combined heat and power, and small wind energy. Several bills introduced last year in the 111th Congress would have created a similar ITC for energy storage systems. For example, Senate Bill 2617, the “STORAGE 2010 ACT,” provided up to \$1.5 billion in tax credits for storage projects connected to the U.S. electric grid, in support of integrating renewable energy resources and facilitating smart grid development. Similar legislation to the STORAGE

ACT, if enacted at the federal level, would provide a substantial injection of up-front financial support to energy storage system development.

4.2.4.1.3 § 1603 Cash Grant In-Lieu of Investment Tax Credit

Section 1603 of the Recovery Act created an attractive alternative to the ITC in the form of a cash grant administered by the U.S. Treasury Department. Recently extended to include properties placed in service in 2009, 2010, or 2011, or placed in service after 2011 if construction began earlier, the cash grant in lieu of the ITC provides payments to qualified applicants in an amount generally equal to 10 to 30 percent of the basis of the property, depending on the property type (U.S. Treasury Department, 2011). The Treasury Department has not issued an estimate of the grants made under Section 1603 in 2010 for renewable energy integrated storage, but it is believed to be small since generally investor and public owned utilities are not eligible to benefit from this section of the Internal Revenue Code. Like the storage-specific ITC, a legislative act could extend the Section 1603 cash grant timeframe and include stand-alone energy storage properties.

4.2.4.1.4 Advanced Energy Manufacturing Investment Tax Credit:

This tax credit, created by the Recovery Act to support domestic manufacturing facilities for advanced energy projects, applies directly to energy storage systems, although only the limited subset used in electric or hybrid-electric vehicles (American Recovery and Reinvestment Act of 2009, Div. B, Tit. I, Subtit. D, Sec. 1302). The 30 percent credit applies toward the cost of the manufacturing facility itself, in contrast to the PTC and ITC, which credit the energy generation facility. The application period for the Advanced Energy Manufacturing Investment Tax Credit has closed and would require an Act of Congress for renewal.

4.2.4.1.5 New Clean Renewable Energy Bond (CREB) and Qualified Energy Conservation Bond (QECB)

CREBs and QECBs are both forms of tax credit bonds made available to public entities, such as electric cooperatives, public power systems, and state, local, or tribal governments to finance renewable energy projects. Like the manufacturing investment tax credit, these programs have not been renewed by Congress and are not accepting applications. To serve as a driver for energy storage system deployment by public entities, including POU's, Congress would have to renew the CREBs and/or QECBs and expand the qualifying technologies to include energy storage technologies.

4.2.4.2 California Programs

Programs that offer financial incentives at the state level include the Self-Generation Incentive Program (SGIP) and the California Solar Initiative (CSI).

4.2.4.2.1 Self-Generation Incentive Program

As discussed in Chapter 2, the CPUC administers the SGIP to promote the installation of various distributed energy systems on the customer side of the meter. “Qualified advanced energy storage systems” meeting certain technical parameters and coupled with eligible wind and fuel cell technologies are eligible to receive financial incentives under the program (California Public Utilities Commission, 2008, p.1). Assembly Bill 1150 (V. Manuel Pérez, Chapter 310, Statutes of 2011) authorized funding for the SGIP through 2014 and opens the program to energy storage systems.⁴⁸

4.2.4.2.2 California Solar Initiative

The CSI is part of California’s umbrella effort to install 3,000 MW of solar statewide under the Go Solar California program. With a budget of \$2.167 billion over 10 years and a goal of reaching 1,940 MW of installed solar capacity by the end of 2016 (California Public Utilities Commission – (c)), the CSI may have an indirect effect on energy storage by heightening the need for complementary technologies like battery storage that can be coupled with distributed solar. The CSI does apply to solar thermal technologies that generate electricity or displace electricity usage (California Public Utilities Commission – (d)). With the passage of AB 1150, end-users may have additional incentive to consider an energy storage complement to their solar system.

4.2.5 Targeted Research and Development Funding

Government financing support for energy storage system deployment in the form of government loans, grants, or tax credits is demonstrably limited. After years of extremely limited federal funding, DOE’s Energy Storage Program experienced a significant boost when ARRA provided \$185 million in federal matching funds to support energy storage projects with a total value of \$772 million.

⁴⁸ See Legislative Analysis, available at: http://www.leginfo.ca.gov/pub/11-12/bill/asm/ab_1101-1150/ab_1150_cfa_20110525_101450_asm_comm.html (created Spring 2011, last accessed July 8, 2011).

These projects will generate 537 MW of new storage systems to be added to the grid when completed. A breakdown of ARRA-funded projects, organized by project category, is shown in Table 3 AARA Funded Energy Storage Technology Demonstration Projects.⁴⁹

The DOE had an energy storage R and D budget of \$20M in FY2011, and the House Appropriations Committee in June 2011 approved \$20M in FY2012 which was \$37,000,000 below the President’s budget request.

Table 3: ARRA Funded Energy Storage Technology Demonstration Projects

<u>Category</u>	<u>Power (MW)</u>	<u>Project Value</u>	<u>DOE Funds</u>
1. Battery storage for utility load shifting or wind during operation and ramping control	57.0	\$145,168,940	\$60,784,483
2. Frequency regulation ancillary services	20.0	\$48,127,957	\$24,063,978
3. Distributed storage for grid support	7.5	\$44,468,944	\$20,350,142
4. Compressed air storage (CAES)	450.0	\$480,962,403	\$54,561,142
5. Demonstration of promising storage technologies	2.8	\$53,075,574	\$25,230,027
Total:	537.3	\$771,803,818	\$184,989,700

(SNL ESS 2010)

Energy Storage Projects in California

For various ARRA funded Energy Storage projects in California, the DOE provided \$151.5 million in ARRA funds. The Energy Commission, through its PIER program, is providing \$6.44 million as cost-share funds for these projects. The recipients are contributing \$477.5 million out of total cost of \$635.46 million for these projects. Also, the PIER program has provided funding for several Energy Storage projects over many years. In 2010-2011, the PIER program has provided \$8.97 million to support several non-ARRA Energy Storage projects. The brief descriptions of the PIER supported active projects are provided here.

⁴⁹ DOE Electricity Advisory Committee, Energy Storage Technologies Subcommittee, “Energy Storage Activities in the United States Electricity Grid”, May 2011, p.3. Available at: http://www.oe.energy.gov/DocumentsandMedia/FINAL_DOE_Report-Storage_Activities_5-1-11.pdf

American Recovery and Reinvestment Act of 2009 Energy Storage Projects in California

PIER: \$6,440,028 Match: \$477,496,532 DOE: \$151,519,268 Total: \$635,455,828

1. **Tehachapi Wind Energy Storage Project: Southern California Edison** will design and build a 32 MWh lithium-ion battery system and smart inverter, and connect it to their Monolith Substation near the Tehachapi Wind Resource Area. This project will demonstrate the ability of the battery storage system to enhance grid operations and integrate intermittent wind power in a remote, transmission-constrained area. The installed system will help achieve utility load shifting, increased dispatchability of wind generation, and enhanced ramp rate control to minimize the need for fossil fuel-powered back-up generator operation. The project will leverage the data and results of an ongoing PIER-funded study on the Antelope-Bailey 66 kV system. The ongoing study aims to determine the ways in which energy storage can address wind integration issues to help meet California's renewable energy goals. One of the key early findings of this study was that a 32 MWh energy storage device located at the Monolith Substation can prevent overloaded transmission lines.

PIER: \$1,000,000 Total: \$53,510,209

2. **Wind Firming EnergyFarm: Primus Power Corporation** will work with the United States Department of Energy, Sandia National Laboratory, Pacific Gas and Electric Company (P G and E), and Modesto Irrigation District to develop, field test, and install and evaluate a 25 MW/75 MWh grid-connected Zinc-based flow battery energy storage system. The project will provide a low-cost energy storage system with a footprint consistent with or smaller than other competing technologies and demonstrate primary and secondary applications including: renewable firming, strategic local peak shaving, automated load shifting, and ancillary services.

PIER: \$1,000,000 Total: \$46,700,000

3. **Solid State Batteries for Grid-Scale Energy Storage: Seeo Inc. (Seeo)** will develop the first ever large-scale or grid-scale prototype of a new class of advanced lithium ion rechargeable batteries, with unprecedented safety, lifetime, energy density, and cost. The primary focus of this project will be the development and deployment of a 25kWh prototype battery system based on Seeo's proprietary nanostructured polymer electrolytes. This will validate the transformational performance advantages of this technology for use in grid-tied energy storage applications. In particular, Seeo seeks to address the utility market needs for clean energy systems, which envision small (<100kW) distributed energy storage systems alongside pad-mounted and pole-mounted transformers, and grid-connected electric vehicle systems.

PIER: \$600,000 Total: \$12,392,122

4. **Fault Current Limiting Superconducting Transformer: Southern California Edison** (SCE), working with Waukesha Electric Systems, Inc. (Waukesha) will design, develop, fabricate, and install a Smart Grid compatible fault current limiting superconducting transformer on SCE's utility host site. The 28 MVA, three-phase, medium power utility fault current limiting transformer will be placed within SCE's MacArthur Substation, which is located in Newport Beach, California and within the project area of SCE's Irvine Smart Grid Demonstration Project. By incorporating fault current limiting capability, the transformer is better able to handle fault currents and represents a cost and space efficient means to bring fault current limiting capability into the substation without adding a separate device, and ultimately improves the grid performance and reliability.

PIER: \$767,134

Total: \$21,406,194

5. **Premium Power Distributed Energy Storage Systems Demonstration: Sacramento Municipal Utility District** (SMUD) will install and demonstrate a fleet of two Premium Power Corporation's Zinc Bromine Flow Battery energy storage systems in Sacramento, California, one at the SMUD Headquarters (East City Substation) serving the SMUD campus micro-grid, and one at a substation serving the nearby Anatolia III SolarSmart Homes community development. The SMUD Headquarters storage system will explore its utility in improving micro-grid operations; emergency operations, including campus islanding; and augmenting peak period campus operation with non-peak generated electricity. The storage system at SMUD's Anatolia-Chrysanthy substation will be integrated with the Anatolia III SolarSmart Homes community, which will have 600 homes totaling 1.2 MW of photovoltaic (PV) generating capacity. The two storage systems will be controlled from a common control system at the SMUD headquarters site to demonstrate fleet control of multiple distributed storage devices. Over a four year period, this project and the technology validation it supports will demonstrate competitively-priced, multi-megawatt, long-duration advanced batteries for utility grid applications and validate the potential penetration of zinc bromine flow batteries, particularly in PV and micro-grid applications by demonstrating multiple use cases.

PIER: \$227,000

Total: \$5,417,123

6. **Utility-Scale Flywheel Energy Storage Demonstration: Amber Kinetics, Inc.**, will demonstrate a prototype utility-scale flywheel energy storage system employing technology advances in composite flywheel rotor materials, magnetic bearing systems, and high efficiency motor-generators. These new technologies, when integrated into a flywheel system, can prove

that flywheel energy storage can be competitive with pumped hydro in terms of cost and efficiency. The goal of the project is to clearly demonstrate the economical and technical viability of bulk flywheel energy storage and renewable energy integration for the electric grid.

PIER: \$369,466 Total: \$10,003,015

7. Flow Battery Solution to Smart Grid Renewable Energy Applications: EnerVault Corporation (EnerVault) will demonstrate the commercial viability of EnerVault's novel iron-chromium redox flow Battery Energy Storage System (BESS). This demonstration comprises of integrating EnerVault's Vault-20 BESS (250kW, 1MWh) with an intermittent renewable energy source - a dual-axis photovoltaic (PV) system. The 36 month project will culminate in the deployment of a Vault-20 Beta system in conjunction with a 150kW PV system at a site in California's Central Valley. Additionally, the operating results will be analyzed and compared to the baseline for final quantification of benefits and operating costs. The capital costs, operating costs, and benefits will be used to determine a Total Cost of Ownership.

PIER: \$476,428 Total: \$9,528,567

8. Smart Grid Demonstration Project: The Los Angeles Department of Water and Power (LADWP) will develop and demonstrate a network of smart grid technologies which also involves battery energy storage systems for electric vehicles. The project goal is to facilitate the establishment of protocols and standards in the Smart Grid Demonstration Project that allow for the measurement and validation of energy savings and fossil fuel emissions reductions associated with an Electric Vehicle Program by specifying, acquiring, and installing a sufficiently-sized Electric Vehicle demonstration network.

PIER: \$1,000,000 Total: \$120,560,000

9. Advanced Underground Compressed Air Energy Storage Demonstration Project: Pacific Gas and Electric Company (P G and E) will design, build and demonstrate the world's first advanced, "second generation" Compressed Air Energy Storage (CAES) design system that requires less fuel, utilizes standardized less expensive turbo-machinery, and captures the waste heat from the compression cycle. This "second generation" design uses readily available proven turbo-machinery that will result in lower capital and operating costs than "first generation designs". The plant design will also include the option for future use of thermal storage to test the potential of adiabatic CAES, a "third generation" technology that would completely eliminate the use of fuel for a CAES plant. The project will use depleted gas fields, located within P G and E's service territory, for compressed air energy storage.

PIER: \$1,000,000 Total: \$355,938,600

Other PIER Funded Energy Storage Projects

10. **Grid-Saver* Fast Energy Storage Demonstration: Transportation Power, Inc.,** Escondido, CA will demonstrate a new, low cost fast energy storage Lithium-ion (Li-ion) battery technology that can help facilitate acceptance of utility-scale renewable energy projects in California and nationwide. Supported by team members Evaira and General Atomics, Transportation Power will evaluate the feasibility of designing a low cost fast energy storage system based on innovative design concepts and, following analysis and validation of the concepts, proceed to prototype demonstration to provide further validation and establish a basis for widespread commercial adoption of such a system. The system approach, trademarked as Grid-Saver, is based on modular building blocks with advanced system integration and control methods. The Grid-Saver program aims to demonstrate the viability of the concept by building, testing, and deploying a 5 MW peak power for periods of up to 10-15 minutes fast energy system comprised of interchangeable lithium battery modules and high-power inverter modules as building blocks that can be produced at relatively low cost and integrated with advanced control technology. This also includes validating the performance and establishing a basis for widespread commercial adoption of such a system.

PIER: \$2,000,000 Match: \$520,004 Total: \$2,520,004

11. **Grid-interactive Photovoltaic System with DC-link Battery Storage Integration: Satcon Technology Corporation,** Boston, MA will demonstrate how high bandwidth automatic voltage control can be applied to mitigate intermittency in power plant output and load induced voltage variations on the utility feeder. It also aims to develop electric energy storage components and a system specifically designed and optimized for grid-tied photovoltaic (PV) applications. To achieve these goals, the project will demonstrate a hybrid electric generation system comprised of a 500 kW PV array, 500 kW grid-connected PV inverter, and integration of 500 kWh state-of-the-art battery technology, to further enable utility-scale renewable energy sources. The 500 kW system is a standard building block for multi-megawatt configurations and scalable to target a utility scale plant of 10 MW. The combined inverter and battery storage system will help mitigate the destabilizing effects of intermittency, thereby supplementing the load demand and limiting output power ramp rates to levels that are compatible with other utility generation resources. The demonstration of advanced inverter and integrated solar PV storage system will be part of the Sacramento Municipal Utility District's solar highway project.

PIER: \$1,972,211 Match: \$1,345,332 Total: \$3,317,543

12. **Evaluation and Optimization of Concentrated Solar Power Coupled with Thermal Energy Storage:** KEMA, Inc. will perform transient thermodynamic modeling of nine different configurations of concentrated solar power-thermal energy storage and analyze optimization and integration of different models for dispatch. This also includes simulation of market outcomes in market simulation and economics models. Also, KEMA will bring the methodology and outcomes of the modeling to the market through dedicated technology transfer activities. The potential benefits include:

- Reduced ancillary services requirements and real time dispatch costs at a system level as a result of improved and managed CSP generation variability and ramping behavior, as well as reduced emissions from substituting for stand-by convention generation for these services;
- Improved system reliability as measured by system dynamic performance (area control error, frequency) and system ability to withstand events such as wind ramping, cloudiness and unit trips;
- Improved system reliability in terms of frequency response to disturbances that are improved as a result of CSP inertial and governor response. (As compared with the lack of same from PV and wind resources);
- Enhanced understanding of the economics - cost benefit comparison - of thermal storage and CSP reconfiguration to avoid gas co-firing and to allow the provision of ancillary services.

PIER: \$447,642 Match: \$173,989 Total: \$621,631

13. **Energy Storage Demonstration and Compressed Air Energy Storage Study:** Pacific Gas and Electric Company will demonstrate sodium-sulfur battery in grid application and study Compressed Air Energy Storage as a viable energy storage system for integrating renewables in California.

PIER: \$2,800,000 Total: \$2,800,000

14. **Using High Speed Computing to Estimate the Amount of Energy Storage and Automated Demand Response Needed to Support California's RPS:** Lawrence Livermore National Laboratory will estimate the amount of energy storage and automated demand response needed to support California's Renewable Portfolio Standard using high speed computing capability of super computer at Lawrence Livermore National Laboratory.

PIER: \$1,750,000 Total: \$1,750,000

4.3 Framework for an Application and Scenario-Based Assessment

Thus far, this report has summarized some of the most important factors for California policy makers to consider in the course of determining a vision for energy storage in California for 2020: the commercial status and cost of energy storage technologies; the policy framework guiding the state's energy and environmental goals; the anticipated needs of the future electricity grid, and the various policy, regulatory, and market drivers that might be implemented to facilitate increased deployment of storage technologies by 2020.

The next step – to develop scenarios for how energy storage maybe applied throughout California's electric power system and to estimate the costs and benefits of such a vision as compared to a scenario without deployment of energy storage – requires an analytical framework with which to assess the costs and benefits of energy storage deployment and prioritization of applications and technology areas for further study or incentive development. This framework will serve as a precursor to the development of specific targets and identification of milestones and actions necessary for development and deployment of energy storage technologies in California.

The remainder of this report analyzes the deployment of energy storage technologies using an application and scenario-based approach. Several major efforts to analyze energy storage in the U.S. and California, including by the U.S. DOE, Sandia National Laboratories, EPRI/E3, and SCE, have utilized applications as a starting place to assess storage value. In its white paper, SCE explains that “focusing on applications defines ‘the problem’ before assessing ‘the solution’” and enables a “complete strategic assessment of storage” that can reflect “all operational uses on the electric value chain” (SCE White Paper, 2010, p.15). The Market and Benefits Guide released by Sandia National Laboratories is careful to distinguish “applications” from “benefits,” an application being essentially a *use* while a benefit “connotes a *value*” which can be monetary (for example, arbitrage value) or societal (for example reduced air emissions from generation) (Eyer, 2010, p.2).

Using three exemplary applications, these analyses will attempt to define the benefits that energy storage technologies bring to the application, associated costs, and likely outcomes for energy storage deployment under two different scenarios. The first scenario is a baseline or “business as usual” assessment based on the current regulatory and market rules, current technical status and fit of storage technologies to the application, and current costs and benefits of meeting the application with storage. The second scenario is an “accelerated” assessment of what policy, regulatory, or other changes, including those related to technology cost, would be needed to spur an increase in energy storage deployment for the application by 2020. When

possible, the application and scenario-based assessment will include a high level comparison of alternative, non-storage solutions for the identified applications. These scenarios, based on key applications, will offer possible pathways for California to pursue, and will identify necessary targets and milestones that must be met along the way.

CHAPTER 5: Applications and Scenarios Analyses for Energy Storage in California

Introduction:

Chapter 4 described the approach to the applications analyses as well as the reasoning behind this framework. This chapter examines each of the three exemplary applications, noting that they do not by themselves represent the full range of the costs, benefits, and value of energy storage. This chapter defines each application, describes the ongoing technical and policy barriers facing the various energy storage technologies that may be appropriate for these applications, and recommends next steps for policy makers and stakeholders.

5.1 Exemplary Application #1: Area and Frequency Regulation

The National Renewable Energy Laboratory (NREL) has identified the emergence of deregulated energy markets, such as those for high-value ancillary services operations, to be one of several primary factors motivating the surge of renewed interest in energy storage (Denholm, 2010, p.9). These services require fast response time and often limited actual energy delivery – both needs for which many energy storage technologies are well-suited. In California ISO’s service area and nationwide, regulation services are the highest-compensated energy market (See Electric Power Research Institute, 2010a, pp.2-10 – 2-11; Denholm, 2010, p.12).

Some stakeholders have noted that market prices for frequency regulation can vary significantly by hour, depending on market conditions, and that grid operators may only have a limited need for regulation given its function to manage the forecast uncertainty and variability over time intervals often less than five minutes. In addition, available regulation-certified resources would compete with energy storage technologies to provide the service. However, studies suggest that area and frequency regulation service will continue to be an important factor to ensure grid reliability under higher renewables penetration. And based on its importance to the grid and its measurable monetary value in California, area and frequency regulation presents a use case for assessing the benefits and costs of baseline and accelerated deployment of energy storage. Note that other studies categorize area or frequency regulation within the broader application category of wholesale energy services (EPRI, 2010a) or simply as one of many ancillary service applications (Sandia National Laboratories, 2010). This assessment will consider area and frequency regulation as a standalone application.

5.1.1 Area and Frequency Regulation: Definition and Application

Frequency regulation service is the injection or withdrawal of real power by facilities capable of responding appropriately to a transmission system's frequency deviations or interchange power imbalance. When generation dispatch does not equal actual load and losses on a moment-by-moment basis, the imbalance will result in the grid's frequency deviating from the standard (60 Hertz). Minor frequency deviations affect energy consuming devices; major deviations cause generation and transmission equipment to separate from the grid, in the worst case leading to a cascading blackout. Frequency regulation service can prevent these adverse consequences by rapidly correcting deviations in the transmission system's frequency to bring it within the acceptable range (FERC, 2011).

Energy storage technologies are well suited to resolve momentary differences between supply and demand, as well as fluctuations in grid frequency. The current frequency regulation method uses gas or steam turbines to balance constantly shifting load fluctuations by periodically adjusting generation in response to a signal from the system operator. Electrical plants use spinning reserves to quickly ramp up to full output when another generator goes offline. However, these generators must run constantly at reduced load to assure power quality, which results in increased greenhouse gas and criteria pollutant emissions.

The use of energy storage technology has the capability to be faster than regulation by a gas or steam turbine. This faster response time can minimize momentary electricity interruptions, particularly at the distribution level, which are more costly than sustained interruptions (LaCommare and Eto, 2004). Energy storage technologies can vary output rapidly, changing from no output to full output within seconds. To optimize efficiency and response time, energy storage technologies used for frequency regulation must be able to communicate with the grid quickly and efficiently. Using storage for frequency regulation can reduce the consequences of rare but costly power interruptions at high-tech industrial and commercial facilities. Taking advantage of the capabilities of faster-ramping resources can improve the operational and economic efficiency of the transmission system and has the potential to lower costs to consumers in the organized wholesale energy markets.

The performance targets of energy storage technologies used for frequency regulation emphasize the importance of discharge duration, response time, and roundtrip efficiency metrics. If an energy storage technology is able to meet these targets for frequency regulation in a cost-effective way, the electric power industry is likely to adopt the technology to assist with the recovery from momentary disturbances.

Table 4: Area and Frequency Regulation Performance Targets for Energy Storage

Metric	Target	Supporting Information
Size	1 - 100 MW	
Discharge Duration	15 minutes to 2 hours	Storage technologies should have symmetric charge and discharge rates for this application.
Response Time	< 1 second	Since this application is intended to reconcile momentary differences, the storage technology must be able to respond to grid signals as fast as possible.
Roundtrip Efficiency	75 - 90%	Roundtrip efficiency is the efficiency measured at the transformer of the energy output divided by the energy input.

(Nexight 2010a, EPRI 2010a, p.4-24)

In addition to technical performance targets, system cost and lifetime are also key metrics that energy storage technologies must meet to offer competitive solutions. Similarly, to be competitive, energy storage technologies must be able to achieve system lifetimes of at least 10 years, based on 4,500 - 7,000 cycles per year (Nexight, 2010b, p. 17).

5.1.2 Area and Frequency Regulation: Technology Status and Market Fit

In a recent study, EPRI evaluated various energy storage technologies for grid applications (EPRI). The organization identified flywheels, lithium ion batteries, and lead-acid batteries as promising candidates to meet frequency regulation performance targets. These systems may also be applicable for smoothing intermittency of wind and photovoltaic power generation as well as power quality applications. All of these systems are modular and can be configured in both smaller and larger sizes.

The figures below represent published ranges estimating the total capital installed cost of “current” turnkey systems based on 2010 inputs from vendors and system integrators (EPRI 2010a, p. 4-24). Included are the costs of power electronics if applicable, and all costs for installation, step-up transformer, and grid interconnection to utility standards. The report also assumes that smart-grid communication and controls are included. In addition, the study noted that pumped hydro, CAES, and flow battery systems may be applicable for frequency regulation and other ancillary services. Analysts face difficulty calculating these values,

however, due to the overlapping applications for the various technologies and their operational uses, which may also be subject to different value measures and regulatory rules. Note that advanced lead acid capital costs are reported on a “rated” MWh delivered per cycle basis.

Table 5: Energy Storage Options for Frequency Regulation

Technology	Maturity	Capacity (MWh)	Power (MW)	Duration (hrs)	Efficiency (%)	Total Cost (\$/kW)	Cost (\$/kWh)
Flywheel	Demo	5	20	0.25	85 – 87	1950-2200	7800-8800
Li-Ion	Demo	0.25 – 25	1 – 100	0.25 - 1	87 – 92	1085-1550	4340-6200
Advanced Lead Acid	Demo	0.25 – 50	1 – 100	0.25 - 1	75 – 90	950-1590	2770-3800

(EPRI, 2010a, p.4-24)

Typical flywheel applications include power quality and uninterruptible power supply (UPS) uses. Manufacturers are positioning flywheels to provide frequency regulation services because they are fast responding and efficient. Analysis of such flywheel services have shown them to offer system benefits such as reducing carbon dioxide emissions and avoided cycling of large fossil power systems. Durability and life-cycle cost data are unavailable at this time. Purchasers should consider the cost of flywheel replacements over the book life in a life-cycle analysis.

In addition to the options identified in Table 5 Energy Storage Options for Frequency Regulation, , ten adjustable speed pumped storage stations are in operation in Japan and Europe and are providing frequency regulation services with the following characteristics that translate to the U.S. site applications presented in Table 6 Adjustable Speed Pumped Storage Characteristics.

Table 6: Adjustable Speed Pumped Storage Characteristics

Technology	Maturity	Capacity (MWh)	Power (MW)	Duration (hrs)	Efficiency (%)	Total Cost (\$/kW)	Cost (\$/kWh)
Adjustable Speed pumped Storage	Advanced	20,000	1,000	10	80-82	1,500-3,500	150-350

(HDR, 2010; MWH, 2009)

Given their attractive cycle life and compactness, in addition to high ac-to-ac efficiency, electric power companies are seriously considering Li-ion batteries for several utility grid-support applications, such as community energy storage, transportable systems for grid-support, commercial end-user energy management, home back-up energy management systems, frequency regulation, and wind and photovoltaic smoothing. Early system trial applications are underway using small 5- to 10-kW/20-kWh distributed systems and large 1-MW/15-minute fast-responding systems for frequency regulation. In addition, several Li-ion developers are demonstrating 1-MW/250-kWh and 2-MW systems. There are several different types of Li-ion chemistries, each with their own cost and performance characteristics. Data shown is the average of currently available systems. Durability and life-cycle cost data are unavailable at this time. Battery life-cycle costs can vary considerably by supplier, depending on the design basis duty cycle and design life and the associated cost of building or container structures for housing. Purchasers should consider battery replacement costs, otherwise not shown, as a variable O and M expense in any life-cycle analysis. Purchasers should also consider the cost of battery replacements over the book life in a life-cycle analysis.

There have been few utility applications for lead-acid batteries due to their relatively heavy weight, large bulk, cycle-life limitations and perceived reliability issues (stemming from maintenance requirements). Work to improve lead-acid battery technology and materials continues. Innovation in materials is improving cycle life and durability, and manufacturers are developing several advanced lead-acid technologies that are in the pre-commercial and early deployment phase. Researchers are developing these systems for peak shaving, frequency regulation, wind integration, photovoltaic smoothing, and automotive applications. There are several advanced lead-acid technologies. Data shown represent an average of currently available systems. Battery life-cycle costs can vary considerably by supplier, depending on the design basis duty cycle and design life and the associated cost of building/container structures for housing. Purchasers should consider battery replacement costs, otherwise not shown, as a

variable O and M expense in any life-cycle analysis. This consideration is especially important with this application, because it involves around a hundred thousand shallow cycles per year.

5.1.3 Area and Frequency Regulation: Technology Potential

Modern mechanical storage applications are capable of providing regulation service, as flywheels and adjustable speed pumped storage technologies demonstrate. Flywheels generally produce 100 to 2,000 kW for periods of time ranging from seconds up to 15 minutes and are thus best suited for high-power, low-energy applications such as grid angular stability and voltage support. Areas for future work include materials development, cost reductions, and improved manufacture techniques (Gyuk and Eckroad, 2003). In addition, scale-up of flywheels could potentially reduce cost through reduction of the required balance-of-plant through the reduction of components (fewer in number but larger in size). Ultimately, purchasers will need field demonstrations prior to wide-scale acceptance of flywheel storage for grid applications. Adjustable speed pumped storage stations are a proven technology, but the incremental revenues associated with frequency regulation markets must offset the incremental cost of the stations.

Batteries can store and release power across a broad range of time scales, smoothing rapid fluctuations in the output of renewable generators or mitigating daily variability. Despite their operational flexibility and potential to provide a wide range of ancillary services, batteries have yet to attain high penetration at grid scale. High cost remains a deterrent, as does a lack of demonstration. The DOE has begun to provide partial funding for storage projects; including a planned 20-MW Li-ion battery system in New York that will provide frequency regulation services and help integrate increased wind and solar capacity. If the cost of batteries drops due to technical innovation and increased production volume, use of batteries for grid applications, such as regulation, could expand substantially (Fertig and Wagner, 2010).

Engineers continue to work to improve lead-acid battery technology and materials. Innovation in materials is improving cycle life and durability, and manufacturers are developing several advanced lead-acid technologies at the pre-commercial and early deployment phase. Manufacturers are developing these systems for frequency regulation, as well as other applications. Some advanced lead batteries have “supercapacitor-like” features that give them fast response similar to flywheels and supercapacitors. Analysts anticipate that advanced lead-acid systems from a number of companies will be in early field trial demonstrations by 2011–2012.

For essentially all energy storage systems, manufacturers will likely reduce future costs after early demonstrations become proven and validated, products become more standardized, and initial engineering costs have been removed. For the electrochemical energy storage

technologies, including batteries and capacitors, analysts expect high volume production of cells to lead to cost reductions. The potential growth of electric and hybrid electric vehicles could result in the demand for high volume production and thus reduced cell costs for all applications. Power companies and grid operators would still need to integrate these cells, such as Li-ion, into systems, complete with thermal management, electronic controls, power conversion, and inter-connections, appropriate for frequency regulation and other applications.

5.1.4 Area and Frequency Regulation: Regulatory Status and Policy Changes

Area and Frequency Regulation may be one of the few areas in which the baseline scenario, which includes changes underway and possible changes under consideration, produces an optimistic picture for the economic and technological feasibility of energy storage. Yet there are many additional changes to regulatory policy that could accelerate the deployment of storage for this application and other ancillary services. These are included in the accelerated scenario.

5.1.4.1 Area and Frequency Regulation: Baseline Characteristics (1)

Grid operators have installed a number of energy storage projects that are providing regulation services in various places across the country and the globe (See Lin, 2011, pp.6-8). The baseline scenario for energy storage thus already includes these demonstrations of viability. In addition, substantial changes have recently affected the regulation services market, and others are underway or under consideration. As described in Chapter 2, California ISO recently approved changes to its tariff for ancillary services, altering the definition of an ancillary service resource to include non-generating resources, reducing the continuous energy requirement for day ahead and real time regulation up and down, and reducing the minimum rated capacity requirement to 500 kW (California Independent System Operator, 2010c). The creation of a Regulation Energy Management (REM) option further enables the participation of Limited Energy Storage Resource (LESR) technologies in California's regulation market, once the software becomes operational (See California Independent System Operator, Board of Governors. 2011d).

Additional changes under consideration include possible implementation of a pay-for-performance or "mileage" payment metric under either California's ISO's Integration of Renewables, Market and Product Review process (California Independent System Operator, 2011e, p.17) or FERC's proposed rule for Frequency Regulation Compensation in the Wholesale Power Markets (Federal Energy Regulatory Commission, 2011, p.124), and a possible determination by FERC to allow classification of energy storage devices within more than one asset class or as a new asset class for accounting and reporting purposes.

If FERC or California ISO (or both) employ any of these additional changes, the price of energy storage for regulation is anticipated to increase beyond its current level. Moreover, utility and

third-party investments in energy storage demonstration projects, continued development of improved electric vehicle technology and secondary use options, and the planned implementation of California's cap and trade program, are likely to reduce technology costs and increase the costs of competing, fossil-fuel resources that are kept online for regulation needs. Thus, even if the CPUC determines not to set any type of energy storage procurement target under AB 2514, energy storage deployment for regulation will experience fewer barriers and may increase as a result.

5.1.4.2 Area and Frequency Regulation: Accelerated Characteristics (2)

California Energy Storage Alliance (CESA) has identified additional refinements that California ISO could implement to remove barriers to energy storage participation in the regulation market and to compensate storage for its additional value-adds. CESA supports a pay-for-performance or "mileage" compensation method that rewards the accuracy and speed with which a system responds to the regulation signals (Lin, 2011, p.11). The additional value could reflect the benefits of increased grid reliability because of faster and more accurate regulation, as well as the ability of fast-responding resources to reduce the overall amount of reserves needed (Denholm, 2010, 12). Higher-value compensation for fast and accurate regulation services may emerge as part of the baseline scenario, based on its consideration at FERC and California ISO, although some stakeholders dispute the need and prefer lower procurement targets accompanied by reduced planning reserves. This change is critical, however, to any accelerated deployment of storage for regulation in California.

CESA has identified further changes to rules and procedures at California ISO that should be made to remove barriers to energy storage participation in regulation. CESA advocates reducing the continuous energy requirement further from the recently revised 30-minute real time and 60-minute day ahead requirements, as well as modifying California ISO's Energy Management System (EMS) to accommodate a negative power dispatch (injection and withdrawal of energy), and employing a "fast first" dispatch algorithm similar to NY-ISO's regulation tariff (Lin, 2011, pp.11-12). From a project finance perspective, the extension of long-term power purchase agreements (PPAs) to accommodate regulation-only energy storage systems, and/or a procurement program similar to resource adequacy at the CPUC, would equalize the field for regulation-centric energy storage with conventional generators that provide regulation services secondary to their PPA-backed provision of wholesale energy (Ibid., p.12). CESA recommends that California ISO work with the CPUC to build regulation capacity needs into the RA program.

An energy storage procurement target under AB 2514 would strengthen the basis for accelerated deployment to service California's regulation needs. As noted in Chapter 2, AB 2514 does not specify what form the targets should take, if any, as a result of the CPUC's

rulemaking. Since LESR for frequency regulation represents the greatest potential value to ratepayers in a growing market, it would serve as a logical starting place for the regulated utilities, should the CPUC promulgate a general energy storage procurement target under AB 2514. A more nuanced target, such as some percentage of California ISO's determined regulation needs for 33 percent (plus) renewables penetration, or some percentage of utility side of the meter capacity, would further incentivize energy storage to make a rapid deployment for this application. However, the CPUC must consider the benefits and costs of such a target, including potential costs to ratepayers if utilities rate base their energy storage investments.

Another important facet of an accelerated deployment scenario for regulation services would be for the CPUC to assign a value for environmental or "incidental" benefits of energy storage. The price assigned to carbon emissions as a result of the anticipated 2012 implementation of the ARB's cap-and-trade regulations can serve as a baseline for this value. Policy makers can go further to include a value for other societal benefits, such as reduced reliance on fossil fuel and increased energy security, reduced criteria air pollutant emissions, and enabling superior operation of the existing generation fleet (Eyer, 2010, pp.134-35). Even if policy makers do not add a price point for these benefits to the valuation equation, they can take these benefits into account in evaluating whether more accelerated deployment measures will support environmental and energy-related policy objectives for the state (and California's cap-and-trade program may place a price on carbon that could accomplish some of these goals even without an incidental benefit calculation).

5.1.5 Area and Frequency Regulation: Benefits and Costs

Conventional generators, including hydro, combustion turbine, and combined-cycle plants, as well as pumped hydro storage, currently meet most regulation needs (Denholm, 2010, p.12). According to NREL, as the amount of variable renewable generation increases, so will the need for "flexibility resources" that can accommodate the increased variability of net load and the differences between demand and variable supply (Ibid., p.34). California ISO's ongoing study of grid needs under 33 percent renewable penetration in 2020 shows up to 1,230 MW of regulation capacity needs to meet the fall maximum regulation up requirement (California Independent System Operator, 2011a, Slide 13; California Independent System Operator, 2011h). And a recent study commissioned by the Energy Commission found that energy storage helped avoid the degradation of the electric system performance without requiring additional regulation resources beyond the current 400 MW (KEMA, 2010, p.48). While conventional resources could possibly meet most of California's regulation needs, the demonstrated capability of energy storage to outperform conventional resources in this application merits consideration of the benefits and costs of both scenarios. In addition, the results of the KEMA study suggest that meeting high-renewables penetration regulation needs

with conventional generation may be problematic, considering that renewable generation will displace a portion of conventional generation best suited to address ramping rates (See KEMA, 2010, p. 55).

5.1.5.1 Benefits of Energy Storage for Frequency Regulation

Studies have found several distinct benefits to enlisting fast responding energy storage resources first, or in lieu of, slower, conventional resources for the provision of regulation services. KEMA, in its research for the Energy Commission, concluded that 3,000 MW of fast-acting storage with a two-hour duration would achieve overall solid frequency performance under a high-renewables penetration scenario for 2020, assuming certain control algorithms were in place (KEMA, 2010, p. 65).⁵⁰ Strategen Consulting, in an analysis conducted for the California Energy Storage Alliance, found that “energy storage is a more effective way of meeting the increasing demand of ancillary services at a lower cost – in both economic and environmental terms – than [conventional] resources” (Lin, 2011, pp.2-3). The likely benefits to utilizing energy storage in this application include reduced overall regulation capacity needs, reduced reliance on conventional resources and stress on existing generator equipment, and reduced greenhouse gas emissions. Taking the opposite approach, meeting future regulation needs without storage would require increased ramping by conventional generators, causing increased maintenance cost, increased wear and tear and reduced lifetime, postponed de-commitment of combustion turbine generators, and increased greenhouse gas and polluting emissions (KEMA, 2010, p. 72).

The Strategen Consulting white paper presented findings that the fast response rate of a flywheel, able to quickly increase or decrease its output to match generating output with load, in comparison to a combined cycle gas turbine, can result in fewer total MW capacity of regulation that needs to be procured (Lin, 2011, p.3). This is due to the fact that faster ramping allows a resource to reach its dispatch target sooner and be re-dispatched more often, as well as to switch directions quickly. In contrast, slower ramping resources at times can provide regulation in the wrong direction due to their inability to respond quickly to a signal change in direction. Faster response time also minimizes costly momentary electricity interruptions, offering substantial savings to high-tech industrial and commercial facilities that depend on uninterrupted power at steady frequency (Nexight Group and Sandia National Laboratories, 2010b, p.16).

The potential to reduce MWs of regulation capacity needs finds support in a 2008 study by Pacific Northwest National Laboratory (PNNL) for the California Energy Commission, which

⁵⁰ Performance degraded when KEMA modeled storage systems with a response rate slower than 5 MW/second. (KEMA, 2010, pp. 63, 76).

found that involving fast responding resources in regulation can help reduce California ISO's regulation procurement by up to 40 percent (Makarov, 2008, p.37). Specifically, the PNNL study concluded that an ideal fast responding resource, defined as one with instantaneous response and unlimited energy, is about 1.7 times more efficient than conventional hydro power units used for regulation and 2.7 times more efficient than combustion turbines. This means that 1 MW of fast responding capacity can substitute for 1.7 MW of hydro or 2.7 MW of combustion turbine. The difference is even greater when comparing fast responding resources to steam turbines or combined cycle plants. As an example of a fast-responding resource, PNNL found that a flywheel is much more efficient than most conventional resources in California, although its limited energy capability makes it less efficient than the fastest hydro resources (Ibid., pp.16, 35-36).

Reducing the capacity need for regulation procurement offers significant environmental and cost benefits. For conventional units to be ready to respond quickly to regulation signals, a large number of units must be kept online and partially loaded or "spinning." These faster and more flexible units may displace lower-cost base-load units, and partial loading may decrease the efficiency of individual units and cause more to be online at a given time (Denholm, 2010, p.17). A 2007 study commissioned by Beacon Power compared the emissions of a 20 MW Beacon flywheel system used for frequency regulation to those of a coal-fired power plant, a natural gas combustion turbine, and a pumped hydro storage plant. Over a 20-year lifecycle in California ISO service territory, the flywheel provided an estimated savings of 103,455 tons of CO₂, or 53 percent savings over a natural gas base-load plant. The savings over a natural gas peaker plant was even higher at 132,917 tons or 59 percent CO₂ emissions (Fioravanti, 2007, p.18). The KEMA study also confirmed that utilization of energy storage avoids emissions associated with scheduling gas turbines for ramping and regulation (KEMA, 2010, p. 76).⁵¹

5.1.5.2 Potential Cost Implications of Energy Storage for Frequency Regulation

The cost effectiveness of energy storage for area and frequency regulation will be determined by competitive market prices for regulation-up and regulation-down, current installed energy storage system costs, and the ability of the storage system to capture monetized value streams from compatible operational uses by "stacking" or aggregating benefits. Operational uses compatible with frequency regulation include provision of spinning/ non-spinning operating reserves, ramping or other ancillary services (when treated as a separate market product), and possibly real-time energy price arbitrage (SCE White Paper, 2010, pp.41-42). However, under current market and regulatory conditions, an energy storage device cannot receive bid awards

⁵¹ California Energy Commission and KEMA, Inc., "Research Evaluation of Wind Generation, Solar Generation, and Storage Impact on the California Grid," Energy Commission PIER Final Project Report, June 2010, p. 76.

for the same capacity simultaneously in multiple California ISO markets; an energy storage device can provide only one of these services at any given time.

Several studies have attempted to provide a present value estimate for energy storage in the regulation services market. As noted in EPRI's primer on energy storage applications, costs and benefits, the resulting values are difficult to compare because the studies employ different metrics, such as \$/kW versus \$/kW-h (as opposed to the \$/MW and \$/MW-h commonly used for pricing and quantities associated with ancillary services), and different assumptions relating to storage system lifecycle, inflation, and discount rates (Electric Power Research Institute, 2010a, pp.2-12 – 2-13). Even so, the range of values reported provides a snapshot of current potential values and highlights the challenge of estimating value when key factors remain uncertain.

In comparison to the estimated present values for other applications, regulation consistently falls within the top few. In EPRI's White Paper Primer on Applications, Costs and Benefits, the highest ranking applications from the regional or utility perspective were: commercial and industrial power quality and reliability; both stationary and transportable storage for transmission and distribution support; and wholesale services with regulation (Electric Power Research Institute, 2010a, p.2-11). The highest value applications from the customer perspective were home energy management and commercial/industrial energy management. In Sandia National Laboratories' Benefits and Market Guide, the highest ranking applications for financial benefit were: substation onsite power; area regulation; transmission and distribution upgrade deferral; time-of-use energy cost management; and load-following (Nexight Group and Sandia National Laboratories, 2010b, p.72, Table 11).

For actual estimated values, with the caveat that market prices can vary significantly, EPRI found one hour of regulation to have a target and high present value⁵² of \$255/kW-h and \$426/kW-h, respectively (Electric Power Research Institute, 2010a, p.2-15, Table 2-5). Using the same (converted) metric, Sandia found one hour of area regulation to have a low and high present value of \$785/kW-h and \$2,010/kW-h, respectively (Ibid., see also Eyer, 2010, pp.79-80). When EPRI assumed certain changes to the regulation market, such as shortening of the minimum energy delivery rules from 60-minutes to 30- or 15-minutes, dispatching fast-responding resources first, compensating for fast response, and/or providing mileage or pay-for-performance payments, the estimated values increased substantially, from less than

⁵² EPRI explains that the target value represents "an average value in the broader U.S. market for stakeholders who might consider investing in energy storage," whereas the high value represents "the value for premium or niche markets that place a particularly high value on the benefits provided by an energy storage system. (Electric Power Research Institute, 2010a, p. 2-6).

\$1,000/kW-h for one hour of fast regulation to over \$6,000/kW-h for fifteen minutes of regulation (Electric Power Research Institute, 2010a, pp.3-17 – 3-18, Figure 3-16).

The estimated present values alone do not provide much insight into energy storage cost effectiveness for regulation services. Present value does not account for the breakdown of benefits between multiple parties, such as the utility, independent third-party, or customer (Electric Power Research Institute, 2010a, p.2-11), nor does it consider system cost.⁵³ Southern California Edison (SCE), however, developed a valuation methodology for the express purpose of examining cost effectiveness. SCE conducted a high-level assessment of economic feasibility under current market conditions for various applications paired with appropriate energy storage technologies options (SCE White Paper, 2010, p.5). SCE's results indicate that even with a higher market value, energy storage for grid-level regulation is not yet cost effective. Using the average of regulation-up and regulation-down prices between 2007 and 2010 in California (years which featured significant price drops in the regulation market), and making other reasonable assumptions about a storage device's participation in current A/S markets, SCE concluded that a 20 MW flywheel with 30 minute energy duration would be cost effective if the current installed costs were to decrease by 25 percent and the average regulation-up and regulation-down market rents were to increase by 50 percent (Ibid., p.44).⁵⁴ This result appears consistent with EPRI's concluding analysis of the cost gap between application values and system cost, although the two reports utilized different end metrics and had different scopes. For frequency regulation, EPRI found that the energy storage technology cost range is in the same range as or greater than the target and high values (Electric Power Research Institute, 2010a, p.5-1, Figure 5-1). But when regulation is provided in addition to other high-value services, such as transportable storage for transmission and distribution deferral, the combined application values may exceed costs (Ibid., p.5-2).

Several important conclusions flow from these assessments. First, in the baseline scenario for energy storage deployment for regulation services, California's regulation market does not offer significant new opportunities beyond its current status. Although regulation-up and -down is California's highest-valued ancillary service, it does not yet constitute an economically feasible application, at least when treated independently of other potentially compatible applications. Second, however, a number of factors could shift frequency regulation into a high-value and

⁵³ The Sandia *Benefits and Market Guide* explains that financial benefit is estimated "without regard to cost" and is "intended to provide a general indication of the price point required for storage to be financially viable. So if storage can be owned and operated for an amount less than the estimated benefit, then the value proposition may be financially viable." Eyer, 2010, p. 71).

⁵⁴ For a detailed list of the assumptions that underlie SCE's cost effectiveness conclusions, see SCE White Paper, 2010, Appendix A, pp. 66-71.

cost-effective application fairly quickly. These include the frequency regulation and energy storage proceedings undergoing review at California ISO and FERC, especially introduction of a mechanism to award fast-responding resources first, a potential increase in competing natural gas plant costs resulting from cap and trade program implementation under AB 32, and anticipated reductions in technology costs, in particular for Li-Ion batteries. As SCE cautioned in its valuation study, pending changes to California ISO's market design as well as the difficult-to-predict effects of complex bidding practices, market liquidity considerations, and the future behaviors of market participants, make any reliance on current valuation conclusions an uncertain indicator of future cost effectiveness (See SCE White Paper, 2010, p.44). This concern may have even more resonance with the current low prices for ancillary services due to extensive supply, which could increase as the California ISO allows more types of non-generation resources to compete in the market.

While it is possible that installed system costs and market rents will shift under the baseline scenario, assuming regulatory changes by FERC or California ISO, policy makers could consider several actions to spur a more accelerated deployment, including the potential for different ownership models (example given utility ownership versus non-utility or third-party ownership) to shift possible risks toward or away from the ratepayer.

5.1.6 Area and Frequency Regulation: Recommended Next Steps and Milestones

Based on the assessment of the technology status, cost, and benefits for energy storage for regulation services, this section outlines goals for PIER research, funding, focus, and collaboration with industry and the CPUC and/or California ISO. It also identifies certain research and/or R and D milestones for policymakers to address in their decision-making.

5.1.6.1 Milestones

Critical upcoming research and technology milestones for policymakers to consider in making decisions on energy storage deployment include the following:

- Final results of the California ISO 33percent renewables integration study, which will forecast the amount of regulation potentially needed
- FERC approval of California ISO's REM program for LESRs and REM implementation
- Completion of Phase 2 of California ISO renewables integration market products proceeding
- Data from California-based ARRA fast-responding storage demonstration projects
- FERC ruling on Frequency Regulation Compensation NOPR
- Implementation of ARB Cap and Trade regulations and other events with cost implications for competing fossil fuel technologies. These cost increases may improve

the cost effectiveness of energy storage technologies relative to natural gas-fired power plants.

5.1.6.1 Next Steps

The Energy Commission's PIER program could focus on the following activities related to energy storage penetration of the area and frequency regulation market:

- PIER funding for studies to review the impacts of recent tariff changes at NY-ISO, ISO-NE, PJM, and other grid operators on energy storage technologies attempting to compete in the area and frequency regulation market. In particular, PIER could examine the impact of the NY-ISO's "fast first" scheduling and ISO-NE's "mileage payment" under its pilot program and consideration of combining mileage payment with performance based pricing.
- PIER funding to study a review of the technical requirements and cost implications of intra-hour and shorter scheduling at California ISO in connection with regional balancing. Shorter scheduling may be necessary to justify tariff changes that would compensate providers for speed and accuracy. Some comments received on this report indicate that compensation for faster or more accurate regulation will not assist energy storage manufacturers unless California ISO implements shorter scheduling, noting the multiple initiatives at the Western Electricity Coordinating Council (WECC) related to intra-hour scheduling and a within-hour energy market.
- PIER could work with the California ISO to assess the potential benefits of utilizing energy storage for needed regulation over existing fossil fuel-based power plants.

5.2 Exemplary Application #2: Renewables Grid Integration

The challenges associated with the integration of variable energy resources (VER) into the electricity grid are a key driver behind the growing interest in energy storage technologies. California ISO presents the renewable grid integration issue as follows:

Although wind and solar average hourly energy production can be forecasted with reasonable accuracy, they will still produce significant intra-hour and minute-to-minute variability that is inconsistent with today's grid operations and scheduling procedures. In addition, sudden weather changes can lead to corresponding variations in wind and solar generation output across the service territory and cause significant energy imbalances on the system.

One strategy for mitigating the challenges of intermittent and variable generation impact on grid operations is to use storage technologies. Energy Storage has the potential to change the current “just in time” paradigm by absorbing energy during one period and delivering it within another period based on system conditions. Storage can address the dilemma of continuously matching supply and demand. (California Independent System Operator, 2010d, p.4; see also Denholm, 2010, p.17).

The Energy Commission likewise has identified energy storage as an important focal point in the 2011 IEPR’s treatment of integrating preferred resources into California’s electricity system (California Energy Commission, 2011a, p.3). And a wide range of studies reinforce the proposition that energy storage technologies can serve a key function in the grid integration of VER. However, these studies note that the actual need for energy storage to “firm” and “shape” output from VER has yet to be quantified (Denholm, 2010, p.16). NREL proposes that whether there is a “‘need’ for energy storage to enable renewable integration is actually an economic question” that requires “comparing the economics of a variety of potentially competing technologies including demand response, transmission, flexible generation, and improved operational practices” alongside energy storage (Ibid., p.1). Important to include in the economic calculation are the expected cost increases stemming from grid integration of VER, including increased regulation procurement, greater operational demands (for example, more starts, more ramping) on conventional resources, and increased need for flexible/ dispatchable capacity (Kristov, 2011, Slide 26).

As noted above with frequency regulation, the economic calculus becomes more difficult when analysts divide the broader application category of “renewables grid integration” into component applications or operational uses, which may overlap and be subject to different value measures and regulatory rules. EPRI’s renewables integration application description includes ramp and voltage support for wind integration, off-peak storage for wind integration, and time shift, voltage sag, and rapid demand support for photovoltaic integration (Electric Power Research Institute, 2010a, p.2-5, Table 2-3). SCE categorizes renewables integration applications as “off-to-on peak intermittent energy shifting and firming at or near generation” and “intermittent energy smoothing and shaping at or near generation” – one or both of which may find value in providing dependable operating capacity, energy firming, energy shifting or wholesale arbitrage, output smoothing, and potentially avoiding “dump” energy and providing transmission system reliability or deferral (SCE White Paper, 2010, pp.36-40). In addition, Sandia National Laboratories classifies short- and long-duration wind generation integration as separate applications from, for example, renewable electric energy time shift and renewable capacity firming (Eyer, 2010).

The breadth of values possible in a renewables grid integration function for energy storage suggest that a valuation methodology will need to define the scope of the application, whether focused on grid-scale or distributed renewables integration, and the inputs to be considered for both cost and benefit. Developing such a model is beyond the scope of this report, but the following analysis seeks to synthesize the relevant technical and policy information that will affect a final determination of feasibility of energy storage for renewables grid integration in California.

5.2.1 Renewables Grid Integration: Definition and Application

The increasing integration of renewable energy into California's energy supply can potentially reduce reliance on fossil fuels and emissions from electricity generation. However, the intermittent nature of most renewable energy sources introduces generation variability that can cause operational and integration issues when connected to the electric grid on a commercial scale. These issues fall into three major time periods for renewable integration: "smoothing" (second-to-second or minute-to-minute), "shaping" (15 to 30 minutes such as for energy imbalance and ramp-up/ramp-down), and "firming" (hour-to-hour shifts for firming and electricity energy time shift to better match renewable production with demand). All three time periods are crucial to renewable integration and can sometimes overlap. Energy storage technologies can support the increased penetration of renewables-generated electricity by smoothing the power from these sources, thereby easing grid operation where large amounts of wind and solar generation have been deployed. To optimize the effectiveness of these operations, storage technologies need the ability to communicate and respond to the grid through the system operator. For storage technologies used for short-duration renewables grid integration, the performance targets shown in Table 8 address roundtrip efficiency, system lifetime, capacity, and response time metrics.

Energy storage can also play a role in long-duration renewable energy integration. The cost of electricity varies along with daily cycles of changing electricity supply and demand. Electricity prices are higher when electricity is in high demand or when supply is low than they are when the demand for electricity is lower or when electricity supply is high. Energy storage can take advantage of lower electricity prices by charging a storage device during times of low price and then discharging this electricity when electricity prices are high. Often the extreme prices (high or low) occur not at peak times or at night, but at times of high rates of change in load or renewable generation. Device charging can also address periods of excess energy supply and mitigate overgeneration issues.

Electric energy time shift is often referred to as arbitrage, which involves the purchase and sale of electricity at different times to benefit from a price discrepancy. For example, electricity generated from wind at night or solar power in the morning can be purchased during these off-

peak times and sold later during on-peak hours. Storage devices used for electric energy time shift, including pumped hydro plants, compressed air energy storage facilities, and large battery installations, can typically store large amounts of electricity to optimize the gain from electricity price differentials and offset the disadvantages of intermittent renewable energy sources by shifting this energy to times when it is needed most. Table 7 portrays Renewables Integration Short Term Metrics by target and associated supporting information.

Table 7: Renewables Integration Short Term Metrics

Metric	Target	Supporting Information
Roundtrip Efficiency	75 - 90%	Roundtrip efficiency is the efficiency measured at the transformer of the energy output divided by the energy input.
System Lifetime	10 years	System lifetime will vary by technology and the number of cycles per year, but 10 years with high cycling would be a sufficient technology lifetime. Some energy storage technologies may require battery pack replacement more frequently, which should be acceptable, assuming the overall life cycle costs are reasonable.
Capacity	1 MW - 500 MW	The capacity need of a storage technology will depend on the size and intermittency of the renewables operation.
Response Time	1 - 2 seconds to < 60 min.	Fast system response times will allow storage to respond to changes in renewable operation to minimize generation fluctuations.

(Nexight Group, 2010b, p.18)

Performance targets for electric energy time shift focus on system capital cost, operations and maintenance cost, discharge duration, efficiency, and response time. The environmental impact of storage devices used for electric energy time shift is also an important factor to consider. If a storage technology is able to meet these targets, the technology is well positioned to be adopted

by the electric power industry as a way to take advantage of the fluctuating price of and demand for electricity. Table 8 portrays Energy Time Shift Applications – Long Duration Metrics with associated supporting information.

Table 8: Renewable Energy Time Shift Applications - Long Duration Metrics

Metric	Target	Supporting Information
Capital Cost	\$1500/kW - \$500/kWh	\$250/kW is a utility-set metric that may not reflect the full value of storage. \$500/kWh is a sufficient metric to make storage competitive with gas turbines.
Operations and Maintenance Costs	\$250 - \$500/MWh	Lower operations and maintenance costs will allow storage to offer the greatest economic advantages for electric energy time shift.
Discharge Duration	2 - 6 hours	The price and demand for electricity may fluctuate over several hours.
Efficiency	70 – 80%	70-80% is an acceptable baseline efficiency for energy time shift.
Response Time	5 - 30 minutes	The price of electricity will remain low or high for several hours, which decreases the need for an instantaneous response. However, technologies with a fast response could provide added value with some frequency response and load following.

(Nexight Group, 2010b, p.19)

5.2.2 Renewables Grid Integration: Technology Status and Fit

5.2.2.1 Short Duration Renewables Integration

The technologies that energy storage experts previously identified as the most promising for frequency regulation - flywheels, adjustable speed pumped storage, Li-ion batteries, advanced lead-acid batteries, and capacitors – also offer performance that could also meet the metrics for short duration renewables integration. For further information on flywheel, Li-ion battery, and

lead-acid battery technologies, see the analysis of technology status, commercial readiness, and ongoing research needs in the frequency regulation application discussion in section 5.1.2.

5.2.2.2 Renewable Energy Time-Shift Applications

Wind integration applications require both bulk storage capacities of 1 to 400+ MW for 4 to 10+ hours and multiple smaller 1- to 20-MW/15- to 60-min systems for smoothing and balancing. Technologies that appear compatible with those requirements include pumped hydro, compressed air energy storage (CAES) primarily with underground storage, large flow batteries such as zinc-bromine and vanadium redox systems, advanced lead-acid batteries, and Li-ion battery and flywheel systems for fast response and smoothing (EPRI 2010a, p. 3-8).

In recent years, the increase of photovoltaic penetration on the distribution grid has presented operational problems for utilities. Energy storage systems can potentially alleviate voltage swings in the distribution grid. Large photovoltaic applications may also require high-power, low-energy storage systems that can perform many cycles and are capable of fast response. Such systems would generally be in the size range of 500 kW to 1 MW or larger with 15 minutes to 1 hr of storage and could include advanced lead acid batteries and Li-ion batteries (EPRI 2010a, p. 3-8). Table 9 presents Bulk Energy Storage for Long Duration Renewables Integration costs, and other data arranged by type of technology.

Table 9: Bulk Energy Storage for Long Duration Renewables Integration

Technology	Maturity	Capacity (MWh)	Power (MW)	Duration (hrs)	Efficiency (%)	Total Cost (\$/kW)	Cost (\$/kWh)
Pumped Hydro	Mature	1,680-5,300	280-530	6 - 10	80 - 82	2,500-4,300	420-430
		5,400-14,000	900-1,400			1,500-2,700	250-270
CAES -CT Underground	Demo	1,440-3,600	180	8	68 - 75	960	120
				20		1,150	60
CAES Underground	Commercial	1,080-2,700	135	8	68 - 75	1,000	125
				20		1,250	60
Sodium-Sulfur	Commercial	300	50	6	75	3,100-3,300	520-550
Advanced Lead-Acid	Commercial	200	50	4	85-90	1,700-1,900	425-475
	Commercial	250	20-50	5	85-90	4,600-4,900	920-980
	Commercial Demo	400	100	4	85-90	2,700	675
Vanadium Redox	Demo	250	50	5	65-75	3,100-3,700	620-740
Zn/Br Redox	Demo	250	50	5	60	1,450-1,750	290-350
Fe/Cr Redox	R&D	250	50	5	75	1,800-1,900	360-380
Zn/air Redox	R&D	250	50	5	75	1,440-1,700	290-340

(EPRI, 2010a, p.4-22)

Pumped hydro storage durations can exceed 10 hours. The pumped storage industry has been investigating the costs of new projects. Manufacturers presently have data on the equipment and civil construction costs because these component costs are virtually identical to ongoing

existing station modernization and expansion projects. However, the lack of large projects under construction means that not much publically available data exist. Costs vary significantly by site, but the values listed above are comparable to industry information and include project contingencies and substation and interconnection costs (EPRI, 2010a, p. 4-22).

CAES systems of up to 400 MW to 2000 MW+ are possible, as are underground storage durations of 20 to 30 hours or longer. Data in the above table are only for the power and storage duration shown. Estimates include process and project contingency and costs for NO_x (SCR) emission-control technology. The data assume a storage cavern with salt geology; costs for other geologies can vary significantly and are site specific. The data do not include costs for siting, permitting, environmental impact studies and geological assessments. Future system costs may be lower once developers make standard, pre-designed systems available. (EPRI, 2010, p. 4-23).

Advanced lead-acid battery cost estimates are based on use of advanced industrial- grade batteries from a number of suppliers. Battery life-cycle costs can vary considerably by supplier depending on the design basis duty cycle and design life. Purchasers need to consider battery replacement costs, not shown here, as a variable O and M expense in any life-cycle analysis. The data include capital costs on a “rated” MWh delivered per cycle basis. Costs for 50-MW systems are based on development of conceptual designs. (EPRI, 2010a, p. 4-23).

Manufacturers can size redox flow battery systems for a wide range of power and duration of energy storage. Developers have not yet built technology options for large vanadium, Zn/Br, Fe/Cr and Zn/air redox to serve large grid-scale (+10 MW) applications. Analysts base estimates on conceptual engineering designs, vendor quotes, site layout and grid interconnection estimates performed by EPRI. Vanadium systems are technically more mature, while Fe/Cr is still in the laboratory and early R and D stage of development (EPRI, 2010a, p. 4-23).

5.2.3 Renewables Grid Integration: Technology Potential

Pumped hydroelectric storage provides quick-ramping large-scale electricity storage that currently provides a range of ancillary services, including regulation, reserve, and capacity. Pumped hydroelectric storage requires two bodies of water at different height, as discussed in Chapter 1. Geography and concerns over environmental impacts limit acceptable sites, but developers continue to identify locations and have filed over sixty FERC preliminary permits. Run of the river-hydro storage may also be able to support intermittent power generation.

Grid operators still need research on all aspects of this energy storage option to better evaluate its potential (Fertig and Wagner, 2010).

As discussed in Chapter 1, two CAES plants are currently operational (one in Alabama and one in Germany) and at least four others are in planning or construction stages. The two operational CAES plants are used for peak shaving, arbitrage, and to supplement the ramp rates of base-load generators. CAES stores enough energy to smooth daily variability in wind and solar power output and can ramp quickly enough to smooth hourly fluctuations. One planned CAES plant, the 270 MW-rated Iowa Stored Energy Park in Dallas Center, Iowa, will be used specifically to smooth wind power output. Current CAES systems use natural gas and have a heat rate about two-thirds that of an efficient natural gas combined cycle plant. Adiabatic CAES systems, which avoid the use of natural gas by storing the heat of compression and using it to reheat the air that exits the cavern, may be feasible in the near future. CAES is more cost effective than present battery technology at the GWh scale and can be sited in suitable geology across much of the United States. Directions for future work include the demonstration of adiabatic CAES and a more thorough valuation of the services CAES provides in different electricity markets under varying levels of renewables penetration (Fertig and Wagner, 2010).

As discussed previously for frequency regulation application, batteries can store and release power across a broad range of time scales, smoothing rapid fluctuations in the output of renewable generators or mitigating daily variability. Despite their operational flexibility and potential to provide a wide range of ancillary services, batteries have yet to attain high penetration at grid scale. If the cost of batteries drops due to technical innovation and increased production volume, analysts expect the use of batteries for grid applications, such as renewable integration, to expand (Fertig and Wagner, 2010).

As discussed in Chapter 1, sodium-sulfur (Na-S) batteries are a commercial energy storage technology finding applications in electric utility distribution grid support, wind power integration, and high-value service applications on islands. The round-trip ac-to-ac efficiency of sodium-sulfur systems is approximately 80percent. The life of a sodium-sulfur battery is approximately 15 years after 4500 cycles at 90percent depth of discharge. Na-S batteries are currently available in multiples of 1-MW/6-MWh units with installations typically in the range of 2 to 10 MW. The largest single installation is the 34-MW Rokkasho wind-stabilization project in Northern Japan that has been operational since August 1, 2008. At this time, about 316 MW of Na-S installations have been deployed globally. Customers in the United States include American Electric Power (11 MW deployed), P G and E (4 MW, in progress), New York Power Authority (1 MW, deployed) and Xcel Energy (1 MW, deployed). All together, more than 316 MW are installed globally at 221 sites, representing 1896 MWh. Analysts anticipate that installed capacity will increase to 606 MW (3,636 MWh) by 2012. (EPRI 2010a, p. 4-10).

Vanadium redox batteries are one of the most mature of all flow battery systems available. Electric power companies have deployed several vanadium redox systems, including (EPRI 2010a, p. 4-11):

- A 15-kW/120-kWh unit operating over three years in a smart grid application by RISO in Denmark
- A 250-kW/2-MWh unit at Castle Valley, Utah by PacifiCorp, which operated 6 years before being discontinued when the application need changed
- A 200-kW/800-kWh unit at King Island, Tasmania by HydroTasmania
- A 4-MW/6-MWh unit at Tomamae, Hokkaido, Japan by JPower
- Smaller 5-kW units that have been deployed in field trials.

Zn/Br batteries are in an early stage of field deployment and demonstration, and are less developmentally mature than vanadium redox systems. While field experience is currently limited, vendors claim estimated lifetimes of 20 years, long cycle lives, and operational ac-to-ac efficiencies of approximately 65percent to 70percent. Module sizes vary by manufacturer but can range from 5 kW to 500 kW, with variable energy storage duration from 2 to 6 hours, depending on the application and need. Electric power companies have deployed small projects comprising 5-kW/2-hour systems in rural Australia as an alternative to installing new power lines. In the United States, electric utilities plan to conduct early trials of 0.5-MW/2.8-MWh transportable systems for grid support and reliability. The first 0.5-MW systems are expected to be deployed in early 2011 by EPRI and a consortium of electric utilities. (EPRI 2010a, p. 4-12).

Fe/Cr redox systems are still in the R and D stage but are rapidly advancing. The low-cost structure of these systems also makes them worth evaluating for grid-storage solutions. (EPRI 2010a, p. 4-14) Given the considerable uncertainties in performance and cycle life, process and project contingencies are high, but continued development followed by demonstration appear warranted.

Thermal energy storage (TES) is commonly associated with concentrated solar thermal power (CSP). In this system, the heat energy from the sun is transferred to a solid or liquid phase change medium (molten nitrate salt is currently favored) and stored for later use, when the heat is transferred to a steam power cycle to drive a turbine. As a result, TES can be considered as another energy storage system to support renewable integration. This technology was demonstrated successfully at Solar Two (10 MW) in Barstow, CA from 1996 to 1999 and has been in commercial operation at Andasol 1 in Spain since 2008. TES is especially applicable to

CSP because it smoothes out variation in solar power during the day and allows electricity generation into nighttime peak demand hours. However, TES raises the already high capital cost of a CSP plant. Key areas of research for this technology include: 1) reducing system capital costs, 2) quantifying the long-term effect of TES on the operation and maintenance of a CSP plant, 3) evaluating the profitability of different TES configurations, 4) evaluating the effect of different policy initiatives on the decision to use TES at a CSP plant, and 5) comparing the economic and environmental implications of TES for power tower and parabolic trough technologies. These last two areas of research are especially important because TES is more efficient and cost effective when coupled with power tower than with parabolic trough CSP. However, parabolic trough CSP is currently the industry leader, and as TES becomes more important to CSP, policymakers may need to examine policy initiatives to shift industry preference to power tower (Fertig and Wagner, 2010).

5.2.4 Renewables Grid Integration: Regulatory Status and Policy Changes

As discussed above, there are numerous storage installations and demonstration projects in use or under construction to assist with renewables grid integration. A prominent example in California is the grid-scale Li-Ion battery storage system procured by SCE for its Tehachapi wind energy project, scheduled for installation in early 2012 with testing taking place through the end of 2014 (Edison International, 2010). The growing number of projects directed toward renewables integration form part of the baseline for energy storage deployment in this application area. But renewables grid integration is not subject to a single, clear set of regulatory rules, such as those that govern bidding into the ISO market for frequency regulation. The value of an energy storage system serving primarily a renewables integration function will be based upon project-specific factors such as grid location, and on regulatory and market factors such as wholesale market energy prices, avoided emissions and avoided curtailment values, and whether the storage capacity can count toward meeting RA obligations or long-term procurement planning needs.

5.2.4.1 Renewables Grid Integration: Baseline Characteristics (1)

At present, the most important characteristic affecting baseline deployment of energy storage technologies for renewables grid integration is the lack of information available regarding the amount, locations, and types of energy storage systems that electric power companies need for system-level renewables integration. Every major study reviewed for this report noted that industry experts generally believe that energy storage will be a key asset in integrating grid-scale renewable generation and providing additional regulation, ancillary services, and T and D congestion relief and upgrade deferral. However, not many studies analyze how much energy storage will be needed and whether energy storage is a cost-effective solution (See Electric Power Research Institute, 2010a, pp.3-4; Denholm, 2010, pp.17, 27). Policy makers and analysts

must consider factors such as where grid operators will locate the energy storage asset, who will operate it, how it will be operated, and how it will fit with the existing portfolio of resources. The limited information available therefore may not provide an adequate basis for industry, utility, and regulatory stakeholders to plan for energy storage systems to support this important set of applications. Nonetheless, the operational and flexibility benefits that energy storage systems bring to renewables integration, along with the values captured through a combination of firm energy production, T and D deferral, and participation in the wholesale energy markets, may continue to drive baseline adoption of energy storage technologies.

Multiple policies currently affect capacity and energy market price signals and long-term contract capability. These include resource adequacy and long-term procurement planning; the price spread between on- and off-peak hours; T and D deferral values; and revisions to market and PIRP rules under the California ISO renewable integration market and product review. As discussed in the following section on cost implications, the impact of these policies on cost is difficult to gauge due to uncertainty in regulatory proceeding outcomes and the earlier described lack of a valuation framework for many of the attendant benefits.

Under current market rules, an LSE cannot count investments in most energy storage technologies toward its RA obligations. As discussed in Chapter 2, the CPUC may respond to stakeholder input and review RA rules to consider participation by more energy storage technologies or to address long-term contracting capability in the context of the AB 2514 proceeding. Without any indication of how the CPUC might decide this issue, the baseline assumption for this report is that most energy storage technologies do not count toward RA obligations and are rarely procured in long term Power Purchase Agreements (PPAs).

However, energy storage may still gain leverage in the current LTPP process based on its ability to fulfill certain identified needs or avoid certain costs. For example, the LTPP preliminary results for 2020 indicate an increased need for regulation and load-following capacity and suggest that some curtailment will be necessary, which could undermine the 33percent renewable energy goal and potentially jeopardize the economics of some existing renewable energy projects. The calculation of revenue requirements for different procurement scenarios includes a cost for incremental transmission additions. The planning methodology includes a proxy RA contract cost to fill any RA capacity gaps, as well as a market balancing tool that purchases unspecified generation or sells surplus energy into the market when the capacity contracted to a service area is out of balance with load– all gaps that could be addressed by coupling energy storage with VER. In addition, all scenarios calculate the impacts of greenhouse gas allowance allocation under the ARB’s draft cap and trade regulation, opening up a possible value for storage in reducing the emissions attributable to IOU ratepayers (See California Public Utilities Commission, 2011c). Thus, even a baseline scenario may present

opportunities for energy storage technologies to achieve value by providing some combination of services – for example,, reducing need for new regulation resources or spinning reserve, eliminating/ reducing curtailment, shifting load to fill capacity gaps, reducing Green House Gasses (GHG) emissions – to the IOUs.

Finally, pending changes to the PIRP program and the market rules affecting VER at the California ISO may create new opportunities for energy storage under the baseline scenario. While the particulars of these pending changes remain uncertain, this analysis does not presume they will have a significant impact. This report therefore addresses suggested considerations for PIRP under the “accelerated” scenario.

With the 33 percent RPS by 2020 driving adoption of renewable resources, a large percentage of which are variable, energy storage will continue to attract the attention of market operators, utilities, other LSEs, and renewable generators. However, more information regarding renewable integration needs and improved clarity in the application of storage to the market mechanisms described may be necessary to increase energy storage adoption at a system level, assuming current baseline policy (including from FERC) and market factors.

5.2.4.2 Renewables Grid Integration: Accelerated Characteristics (2)

In addition to the baseline need for better information and tools that allow energy storage to be considered and valued in the LTPP process, California can implement a number of policies to accelerate storage deployment in applications related to integrating variable renewable energy. All of the changes detailed in Section 5.1.4 on frequency regulation would add value to renewables grid integration, since storage capacity not needed at a given time for integration purposes can bid into the regulation or other ancillary services markets. Incorporating storage in some way into the RA process, or creating a parallel process for guaranteeing a certain capacity of flexible resources to assist with integration needs, would encourage LSEs to evaluate energy storage options for this purpose. One potentially valuable mechanism would apply energy storage as an “adder” toward the RA value for VER, potentially increasing the amount of dependable operating capacity claimed by renewables. Changes made at California ISO to the intra-hour scheduling rules and PIRP should place a high value on forecast and delivery accuracy, providing an incentive for VER to invest in co-located energy storage as insurance against frequent or significant deviations from the forecasted energy delivery. Policy makers are still grappling with the issue of whether the supplier or the customer should bear the costs of mitigating these deviations.

An increase in the spread between off- and on-peak prices that control the value of wholesale energy arbitrage could have a positive effect on the value proposition for storage in integrating excess renewable energy (such as wind) generated at night or in off-peak hours. However, an

increase in the price spread may be unlikely if increased utilization of energy storage and demand response narrow the off-on peak gap between load and generation (SCE White Paper, 2010, p.36), and as the investor-owned utilities develop and promote strategies for permanent load shifting under the direction of the CPUC, as described in Chapter 2. Electric vehicle charging during off-peak hours may have a similar effect (See Eyer, 2010, p.66).

To address shorter-term variability and fast ramping requirements, a possible policy measure could impose ramping limits on renewable generation resources as an interconnection requirement. This would allow the renewable generator to select what type of resource to use (for example, storage or combustion turbine) and to decide between several business models (for example, self-procure onsite ramping capability, purchase in California ISO market, or procure directly from a third party). (KEMA, 2010, p.72)

Energy storage procurement targets under AB 2514 could accelerate deployment, particularly in support of renewables grid integration. Should the CPUC determine targets to be appropriate, it could structure the targets to support the legislature's initial emphasis on renewables integration, as demonstrated by the opening text of AB 2514:

The Legislature finds and declares all of the following:

(a) Expanding the use of energy storage systems can assist electrical corporations, electric service providers, community choice aggregators, and local publicly owned electric utilities in integrating increased amounts of renewable energy resources into the electrical transmission and distribution grid in a manner that minimizes emissions of greenhouse gases.

(b) Additional energy storage systems can optimize the use of the significant additional amounts of variable, intermittent, and off-peak electrical generation from wind and solar energy that will be entering the California power mix on an accelerated basis. (Assembly Bill 2514 (Skinner, Chapter 469, Statutes 2010). Sec. 1(a)).

One possibility would be to tie any procurement targets under AB 2514 to the annual procurement planning for 33 percent renewables, mandated under the April 12, 2011 enacted California Renewable Energy Resources Act (SB 2, Simitian), as a means to avoid forced curtailment of renewable resources and increased greenhouse gas emissions from natural gas-fired power plants used to integrate renewables. This approach would require the subject utilities to include storage in their renewable procurement planning, possibly to meet a certain percentage of the additional capacity or to create a certain capacity "buffer" against variable delivery by the renewable resources that are procured. An alternate or complementary

approach, directed toward deployment on the customer-side of the meter, would identify an overall target to encourage energy storage system installation in conjunction with utility smart grid deployment plans and with distributed generation systems supported by statewide programs like the SGIP and CSI. Energy storage systems at the distribution-level and system-level would require a different set of regulatory changes to remove barriers to participation in ISO markets.

As with any other type of regulatory mandate, the cost effectiveness of accelerated deployment based on these kinds of strategies requires careful evaluation. In addition, the same consideration of environmental and “societal” benefits discussed earlier, including the identification of a value that goes beyond the price point to be set by cap-and-trade, would provide additional leverage for an accelerated vision of storage deployment for renewables grid integration.

5.2.5 Renewables Grid Integration: Benefits and Costs

The benefits and costs of utilizing energy storage to integrate large amounts of variable renewable energy into the grid are relative to those of utilizing the alternative, which are primarily conventional generators. The uncertainties relating to potential market and regulatory changes and the lack of information regarding the necessary scale of integration services combine to constrain efforts to quantify the benefits and costs. The following assessment therefore weighs the known or presumed benefits and costs in the context of pending or possible regulatory and market changes.

5.2.5.1 Benefits of Energy Storage for Renewables Grid Integration

In its analysis of the role of energy storage with renewable electricity generation, NREL emphasizes an understanding of how current resources address electricity demand variability, primarily by the up and down cycling of conventional generators. (Denholm, 2010, p.17). Partially loaded generators and responsive load (for example, demand response) provide contingency reserves and some regulation services. NREL points to four significant impacts of increased variable generation: (1) increased need for frequency regulation (discussed above), (2) increase in ramping rate, (3) uncertainty in wind resource and net load⁵⁵, and (4) increase in overall ramping range (Ibid., p.18). Other studies have also identified increase in ramping as a primary challenge resulting from growing VER penetration. (See KEMA, 2010, pp.50-51).

⁵⁵ The NREL report treats VER as a source of demand reduction, such that wind and solar generation reduces load, leaving conventional generators to meet the “residual” demand of normal demand minus the electricity produced by wind/solar. Thus, uncertainty in wind production combined with uncertainty in load can increase net load uncertainty. See Denholm, 2010, p. 18, Fig. 4.1.

Sandia National Laboratories frames renewables grid integration as requiring dual solutions: short-duration to address ramping needs, and long-duration for electric energy time-shifting and load following to balance and align production with demand (Nexight Group and Sandia National Laboratories, 2010b, p.17).

Although “ramping” is not currently a market product, California ISO may decide to create such a product to better address renewables grid integration (SCE White Paper, 2010, p.19). KEMA found that lower than optimal amounts of storage might be sufficient to maintain system frequency during normal operations or between ramp periods (10A.M.-4P.M.) but would result in degraded ramping performance during the daily morning and afternoon ramps (KEMA, 2010, pp.67-68). By contrast, co-locating energy storage with renewable generation enables off-to-on peak intermittent energy shifting, providing firm power that reduces the need for increased ramping as well as frequency regulation and additional operating capacity (SCE White Paper, 2010, p.36). Where grid operators require ramping, energy storage technologies offer important benefits, based on response speed and the avoided emissions and cost of retaining combustion turbine gas plants online for the same purpose (KEMA, 2010, p.55; Electric Power Research Institute, 2010a, p.3-7).

Another significant benefit for renewables integration may be the potential for energy storage to reduce the need for or amount of curtailment. Wind integration studies have shown that without some type of “outlet” for “excess generation” during periods of high production and low demand, conventional generators must reduce output or wind energy must be curtailed (Denholm, 2010, pp.23-24). This challenge is likely to increase as VER displaces load-following conventional units that might have the flexibility to reduce output quickly. According to NREL, the cycling down of conventional units has technical and economic consequences, just as curtailment has adverse economic consequences for VER. (Ibid, p.25-26, 31). These consequences may be avoided by utilizing storage for electric energy time shifting and to meet ramping requirements. In addition, storage can improve the capacity factor of wind generation resources, especially when considering curtailment due to over-generation or transmission constraints (Electric Power Research Institute, 2010a, and p.3-5). However, these studies emphasize that regional system operators need further research into where and how much energy storage is needed to address wind variability and system balancing.

Increasing amounts of large-scale photovoltaic generation facilities in California similarly will require solutions to mitigate voltage sag and rapid shifts based on cloud cover, the effects of which may be more severe than wind ramp because of the rapid rate of change (Electric Power Research Institute, 2010a, p.3-8). Fast-responding energy storage systems may be able to mitigate such voltage swings quickly to minimize integration costs. Compared to wind, fewer

studies have focused on large-scale photovoltaic integration needs, creating a need for further research in this area.

The benefits of energy storage for both wind and photovoltaic grid integration may extend into savings in avoided transmission and distribution infrastructure investments. Of the anticipated \$400 billion and \$200 billion that utilities will have to spend on distribution and transmission infrastructure, respectively, in the next 15 years, a sizeable portion of that infrastructure is needed less than 400 hours per year during peak demand highs (Electric Power Research Institute, 2010a, p.3-9). Most studies rightly classify transmission and distribution deferral as a separate application from renewables integration based on different performance and locational needs.⁵⁶ However, substantial benefits can accrue to the grid from electric energy shifting and peak shaving at or near the generation site. Sandia National Laboratories notes that developers can locate a project using energy storage to time-shift energy from intermittent renewables so that it also time-shifts wholesale electric energy from the grid, possibly providing transmission support or a T and D upgrade deferral benefit (Eyer, 2010, pp.128-129). Stated differently, the ability of energy storage for renewables grid integration to complement and serve multiple other uses, including transmission and distribution upgrade deferral (Eyer, 2009, pp.51-52, is itself a valuable benefit.

5.2.5.2 Potential Cost Implications of Energy Storage for Renewables Grid Integration

As noted above, the cost effectiveness of energy storage for renewables integration will be based upon project-specific factors, especially operating cost and storage efficiency and regulatory and market factors affecting the wholesale energy price and the other potentially complementary value streams, such as avoided emissions, capacity, and T and D upgrade costs. Because “renewables grid integration” can span multiple uses and value streams, providing a single present value estimate is difficult. In their respective valuation analyses, Sandia National Laboratories and EPRI provide high and low value estimates for the applications shown in Table 11 Application value Estimates.

⁵⁶ For a complete assessment of T&D deferral benefits from modular energy storage, see Eyer, 2009.

Table 10: Application Value Estimates

Application	Sandia National Laboratories	EPRI
Electric energy time shift/ Price Arbitrage	\$400/kW - \$700/kW	\$134/kW - \$800/kW
Renewables energy time shift	\$233/kW - \$389/kW	\$201/kW - \$500/kW
Electric supply capacity	\$359/kW - \$710/kW	\$220/kW - \$726/kW
Renewable capacity firming	\$709/kW - \$915/kW	\$88/kW - \$484/kW
Load following	\$600/kW - \$1,000/kW	NA
Electric supply reserve capacity	\$57/kW - \$225/kW	\$80/kW - \$220/kW
Renewable grid integration – short duration	\$500/kW - \$1,000/kW	\$104/kW - \$311/kW
Renewable grid integration – long duration	\$100/kW - \$782/kW	\$104/kW - \$1,866/kW

(Eyer, 2010, p.72, Table 11; EPRI, 2010a, p. 2-15, Table 2-5)

Depending on the type of energy storage installation, its performance characteristics, and its location on the grid, energy storage for renewables grid integration may be able to access some combination of these values at different times, as well as the value for other services like area regulation and transmission upgrade deferral. After reviewing twelve basic possible energy storage application-technology pairs, SCE concluded that “applications with the greatest potential directly address the longer duration decoupling of supply and demand” because of the “aggregated benefit streams associated with deferring or displacing peak-related costs over several hour durations” (SCE White Paper, 2010, p.9). Still, energy storage applications for renewables grid integration do not fall within the top-tier value propositions in the leading cost analyses, although SCE found long-duration integration uses to be promising although not yet cost effective.

In its cost effectiveness valuation,⁵⁷ SCE modeled both a 300 MW pumped hydro facility and a 20 MW, 6-hour Na-S battery for off-to-on peak intermittent energy shifting and firming at or near generation. It also modeled a 10 MW, 30-minute flywheel for intermittent energy smoothing. SCE found that based on current net present values, none of these technologies

⁵⁷ For a detailed list of the assumptions that underlie SCE’s cost effectiveness conclusions, see SCE White Paper, 2010, Appendix A, pp. 66-69.

were cost effective. To be cost effective by 2020 for energy shifting and firming, the pumped hydro storage facility would require installed cost to fall by 35percent, transmission avoided cost to increase by 25percent, and market rents from energy arbitrage to increase by 50percent. The Na-S battery would require technology installed cost to fall by 50percent and market rents from energy arbitrage to increase by 75 percent to be cost effective. For intermittent energy smoothing, SCE found that the flywheel installed technology cost would need to drop by 50percent and market rents would need to increase by a factor of 100 (SCE White Paper, 2010, pp.37-38, 41).

Notwithstanding the significant gaps between the current and cost-effective value estimates, SCE concluded that energy shifting and firming holds promise because of falling battery technology costs and the potential for off-peak renewable energy production, which theoretically could increase the arbitrage value of energy shifting (Ibid., p.39). This effect is far from certain; Sandia National Laboratories' notes that even modest deployment of electric and plug-in electric vehicles "could lead to a non-trivial decrease in that all-important difference between on-peak and off-peak energy prices," threatening to decrease the value of electric energy time shifting (Eyer, 2010, p.75). In addition, SCE and other studies have noted that as energy storage and other electric energy shifting and load shifting technologies gain market share, the high-and-low peak price differential may decrease further (see SCE White Paper, 2010, pp.75-77).

For shorter-duration energy smoothing applications, SCE concluded a low likelihood of cost effectiveness in the near or medium-term future but also cited the lack of metrics to guide a valuation based primarily on avoided renewable integration costs (SCE White Paper, 2010, p. 41). Addressing this point in its 2010 evaluation of renewable generation and energy storage impacts on the California grid, KEMA noted that while energy storage systems are more expensive than combustion turbines for managing ramping and VER volatility, "the avoided emissions and wear and tear may make the incremental cost worthwhile" (KEMA, 2010, p.72). KEMA also recommended additional research on the cost value of both of these sets of benefits.

Policymakers and purchasers need research to address the considerable uncertainty surrounding how wholesale energy prices and price differentials will change over the course of the next ten years and under different scenarios for off-peak renewable production, electric vehicle off-peak charging, and electric energy time shifting and load shifting. Without further research, the near and mid-term prospects for cost-effective energy shifting uses in connection with renewables grid integration remain unclear. Similarly, without a clear valuation metric that places a price on avoided renewable integration costs, energy storage technologies serving integration needs may not be able to recapture the cost of the benefits they provide. California ISO's consideration of cost allocation mechanisms for the integration of VER, including the

possible use of incentives for VER to manage their own variability and reduce impacts on grid operations (Kristov, L. 2011, Slide 26), may ultimately provide clarification regarding the value of avoided VER integration costs.

This type of metric is easier to create for some products than others. For electric supply capacity, purchasers can calculate the value offered by energy storage based on the avoided cost of installing new generation or on the price of procuring generation capacity in a regulated wholesale electricity market (Eyer, 2010, p.76). If the California ISO one day creates a capacity product, its price can be set for the wholesale level, possibly accounting for the avoided emissions and pollution benefits of utilizing storage for capacity as opposed to combustion turbines. The cost of avoided emissions will be easier to calculate once the ARB implements cap and trade in accordance with its AB 32 Scoping Plan in 2012.

5.2.6 Milestones and Next Steps for Energy Storage for Renewables Grid Integration

As with Section 5.1.6 above, this section suggests goals for PIER research, funding, focus, and collaboration with industry and the CPUC and/or California ISO. It also identifies certain milestones for policymakers at the CPUC and the Energy Commission to consider.

5.2.6.1 Milestones and Next Steps for Energy Storage for Renewables Grid Integration

Critical upcoming research and technology milestones for policymakers to consider include the following:

- Final results of the California ISO 33percent renewables integration study
- Completion of Phase 2 of California ISO renewables integration market products proceeding
- Implementation of legislation to extend SGIP funding for energy storage with the potential to finance standalone and solar-coupled energy storage systems (AB 1150 [V. Manuel Pérez, Chapter 310, Statutes of 2011])
- Data from California-based ARRA grid storage demonstration projects
- FERC determination on the Request for Comments Regarding Rates, Accounting, and Financial Reporting, as it particularly relates to asset classification and whether energy storage technologies can qualify as transmission asset and how operators of these technologies can be compensated for providing multiple services (for example, transmission and generation or ancillary).
- Implementation of the ARB cap and trade regulations and other events with cost implications for competing fossil fuel technologies. These cost increases may improve the cost effectiveness of energy storage technologies relative to natural gas-fired power plants.

- The filing of proposed changes to the California ISO PIRP, which could increase the incentives for PIRP resources to couple with energy storage technologies

5.2.6.2 Next Steps

The Energy Commission's PIER program could focus on the following activities related to energy storage and renewables integration:

- Funding for studies on how energy storage could operate in conjunction with demand response technologies. Can energy storage increase the value, responsiveness, and accuracy of demand response? Can energy storage increase the value by making participation in demand response programs more palatable to end users with specific electricity needs?
- Funding for a study on value of energy storage depending on location. How dramatically does the value of the device change if it is sited with generation versus on the grid closer to load? These questions are relevant to determine whether policy should encourage co-locating energy storage with generation assets, such as by changing the PIRP program or by the CPUC placing ramp limits on VERs.
- Funding a cost study on new, fast, and efficient natural gas plants, such as GE's recent technology discussed in Chapter 3, Section 3.2.3, and how these options compare for integrating renewables versus energy storage devices.
- PIER could work with the CPUC to define which applications fall within the "grid renewables integration" category and what their valuation (such as frequency regulation for grid renewables) should be.
- PIER could partner with the CPUC to develop a valuation of energy storage technologies for renewables grid integration. The CPUC could look to SBX1-2 for direction on how energy storage may add value by reducing indirect costs associated with transmission investments and operational needs for integrating eligible renewables, both of which are to be considered in LTPP process for 33percent renewables (Sec. 399.13(a)(1), (4)).
- PIER and the CPUC could review how demand response can apply toward RA obligations, perhaps as a model for energy storage. The review could focus on the possibility that utility procurement of energy storage could increase the capacity rating of variable renewables for RA purposes.
- PIER could work with California ISO to account for the environmental and greenhouse gas costs of utilizing natural gas power plants and current fossil fuel plants for increased regulation and integration needs to meet the 33percent goal.

5.3 Exemplary Application #3: Community Energy Storage / Distributed Energy Storage Systems (DESS)

Community energy storage or distributed energy storage systems (DESS) offer electric utilities a different approach to grid management from applications related to regulation or system-level renewables grid integration. Locating DESS near load expands the range of potential uses and applications to address grid-level, distribution-level, and community end-user needs. Although this analysis focuses on utility-side DESS, distributed storage technologies placed on the customer side of the meter would offer other services for commercial/industrial and residential electricity end users. As California implements its ambitious clean energy agenda, locally sited storage may play a key role in various other applications, such as integrating variable distributed generation and implementing smart grid and electrified transportation programs.

5.3.1 Community Energy Storage: Definition and Application

Community energy storage, or distributed energy storage systems (DESS), involve small energy storage systems sited on the utility side of the meter, typically next to a pad-mounted transformer serving four to eight residences, a business park, a campus, or multi-family units. Operators can remotely control individual DESS units to manage their individual charge and discharge activity in response to regional need at the circuit, substation, or system level. Analysts envision such units to support grid peak loads in the summer months and to provide backup support as needed. Applications for DESS include:

- Distribution Deferral; Peak Shaving,
- Reliability, and
- Dual-Mode Frequency Regulation.

Figure 17: Concept of a Neighborhood Using DESS

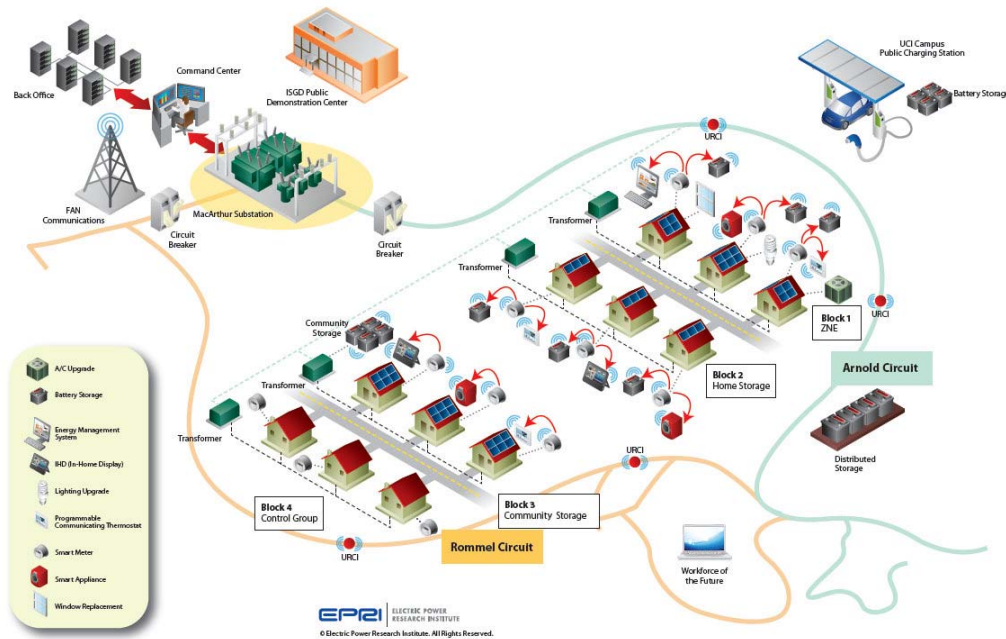

(SCE & EPRI, EPRI Smart Grid Demonstration Initiative, 2010, p. 9)

While the definition and specification of DESS systems are still evolving, (EPRI 2010a, p. 3-11) individual DESS units might typically have nominal capacities of 25 to 50 kW with 2 to 4 hours of storage capability. Electric utilities could control, manage, and aggregate the DESS units using an integration platform to provide large-scale grid support management. However, other business models may also emerge in which cities or third parties own the systems. To employ DESS, utilities will require storage devices with low cost, long life (15 years or more), low maintenance, and a small footprint. Technology options include advanced lead-acid, Li-ion, and flow type batteries.

5.3.2 Community Energy Storage: Technology Status and Fit

This application is primarily for utility-side-of-the-meter grid-support applications at the end of the line, near pad-mounted transformers. These systems also could be located near end-use customers or on the customer side of the meter for energy management, power quality and reliability. In those applications, electric utilities may gain from distribution grid support and peak load management.

All systems are modular, and operators can configure them in both smaller and larger sizes not represented. Ideally, systems with 3 to 4 hours of energy duration may be of most value for grid peak management. Figures in the table below represent estimated ranges for the total capital installed cost of “current” systems, based on 2010 inputs from vendors and system integrators. The data include costs of power electronics (if applicable) and all costs for

installation, step-up transformer, and grid interconnection to utility standards. The data also assumes that smart grid communication and controls will be included. The data do not include siting and permitting costs and base installation costs on aboveground configurations.

Table 11: Distributed Energy Storage System Metrics

Technology	Maturity	Capacity (kWh)	Power (kW)	Duration (hrs)	Efficiency (%)	Total Cost (\$/kW)	Cost (\$/kWh)
Advanced Lead Acid	Demo-Commercial	100-250	25-50	2 - 5	85-90	1600-3,725	400-950
Zn/Br Flow	Demo	100	50	2	60	1450-3,900	725-1,950
Li-ion	Demo	25-50	25-50	1 - 4	80-93	2,800	950-3,600

(EPRI 2010a, p. 4-28)

For batteries, values are reported at rated conditions based on reported depth of discharge. Costs include both process and project contingency depending on technical maturity of the system. This chapter previously presented the status of battery technologies for frequency regulation and renewable integration applications, with key findings summarized here for community energy storage applications.

Cost estimates for advanced lead acid batteries are based on use of advanced industrial-grade batteries from a number of suppliers. Battery life-cycle costs can vary considerably by supplier depending on the design basis duty cycle and design life. Purchasers need to consider battery replacement costs, not shown, as a variable O and M expense in any life-cycle analysis. Capital costs are reported on a “rated” kWh delivered per cycle basis.

Flow batteries have limited deployment in this application. Redox battery systems can be sized for a wide range of power and hours of energy storage. While the chart only shows the Zn/Br option, other redox chemistries may also find application in this setting but may need to include additional siting and permitting costs depending on the technology. The estimates are based on engineering designs and vendor quotes and include site layout and grid interconnection estimates performed by EPRI.

Electric utilities are actively considering Li-ion battery systems for this application. As discussed in Chapter 1, there are several different types of Li-ion chemistries, each with their

own cost and performance characteristics. Data shown is the average of currently available systems. Each chemistry has its own cost structure, so actual selected system costs may vary. Durability and life-cycle cost data are unavailable at this time, and a life cycle analysis should include battery replacements costs over the book life. Developers are testing numerous Li-ion systems for this application in 2011.

5.3.3 Community Energy Storage: Technology Potential

As discussed in Section 5.1.3, for essentially all energy storage systems, future costs can be reduced once early demonstrations are proven and validated, products become more standardized, and initial engineering costs have been removed. For the electrochemical energy storage technologies, including batteries and capacitors, significant cost reductions may come from high-volume production of cells. The potential growth of electric and hybrid electric vehicles could increase demand for high-volume production and thereby reduce cell costs for all applications. Operators would still need to integrate these cells, such as Li-ion, into systems, complete with thermal management, electronic controls, power conversion, and inter-connections, appropriate for frequency regulation and other applications.

Researchers continue to improve lead-acid battery technology and materials, as discussed in Section 5.1.2. Some advanced lead batteries have “supercapacitor-like” features that give them fast response similar to flywheels and supercapacitors. Advanced lead-acid systems from a number of companies are anticipated to be in early field trial demonstrations by 2011–2012.

Zinc-bromine is a type of redox flow battery that uses zinc and bromine in solution to store energy as charged ions in tanks of electrolytes, as discussed in Section 5.2.3. Small projects comprising 5 kW/2-hour systems are being deployed in rural Australia as an alternative to installing new power lines. In the United States, electric utilities plan to conduct early trials of 0.5 MW/2.8 MWh transportable systems for grid support and reliability.

The first 0.5 MW systems are expected to be deployed in early 2011 by EPRI and a consortium of electric utilities. (EPRI 2010a, p. 4-14).

Li-ion batteries are being seriously considered for several utility grid-support applications such as DESS (community energy storage). Both electric utilities and Li-ion vendors are interested in selecting one or two high value grid-support applications that offer a combination of large market size and high value to accelerate the volume production of PHEV batteries. Many analysts believe stationary markets for Li-ion batteries could exceed those for transportation. Early system trial applications are underway using small 5 to 10 kW/20 kWh distributed systems. Several electric utilities are also planning to deploy DESS systems in the 25 to 50 kW size range. In addition, Li-ion developer Altair Nanotechnologies has 1-MW/250-kWh trailer-

mounted Li-ion battery systems in service with both AES and PJM, while A123 Systems has a 2 MW unit serving the California ISO and another 12 MW installed by AES Gener at a substation in Chile. In total, vendors have deployed approximately 18 MW of grid-connected advanced Li-ion battery systems for demonstration and commercial service. (EPRI, 2010a, p. 4-18).

5.3.4 Community Energy Storage: Regulatory Status and Policy Changes

No single set of policies, regulations, or market rules is likely to impact deployment of DESS for utility-side applications. The CPUC regulates distributed generation programs on both the utility and customer-side of the meter. Because these programs may increase local reliability concerns, they may serve as a driver for more distribution-level storage. In addition, the California ISO monitors local capacity needs on a local/regional level and identifies areas with local reliability problems and limited import capability. These areas may be attractive sites for DESS deployment (California Independent System Operator, 2009, p.5). Some uses for DESS on the utility side of the meter, such as peak shaving and frequency regulation, may require access to the wholesale energy markets. Other benefits of DESS may rely on a valuation methodology to calculate avoided cost, such as for variable distributed generation integration and for distribution system upgrade deferral. Still other benefits may only become available with changes to the RA regulatory process.

5.3.4.1 Community Energy Storage: Baseline Characteristics

At present, a number of programs exist to expand the contribution of renewable distributed generation to California's electricity generation portfolio. The SGIP and CSI programs provide incentives for utility customer installation of distributed generation, including solar, wind turbine, fuel cell, and corresponding energy storage systems when applicable, all of which affect deployment of distributed energy storage systems. Other CPUC programs support utility-side or wholesale distributed generation (See California Public Utilities Commission - (a)).

In addition, the extension of tradable Renewable Energy Credits to distributed generation owners creates additional financial incentive for distributed energy resources.

The CPUC regulates the interconnection of these facilities and is engaged in a working group process on renewable distributed energy resources interconnection rules reform (See California Public Utilities Commission - (b)). A report commissioned by the CPUC in 2010 found that distributed generation deployment has not had any noticeable impacts yet on transmission and distribution infrastructure. However, projected distributed generation growth and the possibility of a high-penetration distributed generation scenario raises potential reliability, power quality, and transmission/distribution-related complications (Itron, 2010, pp.3-10, 4-1 - 4-

3). The continual increase in variable distributed generation – and potentially in the cost of integration – may set a baseline need for distribution-level DESS.

The investor-owned utility Smart Grid Deployment plans may provide an additional incentive for development, demonstration, and deployment of DESS. For example, SDG&E emphasizes a vision for its smart grid based on “smart” customers, a “smart market,” and a “smart utility.” The goal of the “smart market” is to empower customers to eventually participate in demand response and possibly even ancillary services markets, maximizing the efficiency of customer-sited distributed energy resources (San Diego Gas and Electric, 2011b, p.28). This vision requires the utility to ensure sufficient communication and balancing systems for California ISO to maintain reliable service in the face of substantial changes in supply and demand at the local or regional level. Although not likely to be a factor in the near-term, implementation of this type of smart grid plan will require flexible resources like DESS that the utility can control to mitigate local variability at the distribution level.

Also present in a baseline scenario is the value of distribution upgrade deferral that may be enabled by an energy storage device installed to reduce overloads on distribution lines and improve power quality, reducing the need for infrastructure replacement or upgrade. This value stream depends upon a clear and consistent valuation methodology for calculating deferral value, creating a separate avoided cost calculation for this particular use. Depending on the location of the DESS on the distribution grid, additional value could come from avoided transmission fees, where larger DESS modules can provide on-peak energy closer to load, relieving some of the on-peak energy flow in congested transmission lines (SCE White Paper, 2010, p. 49).

Participation in the wholesale energy market via price arbitrage may be necessary for DESS to realize the value from peak shaving, depending on the ownership model. Although the energy is stored downstream of the transmission system, a utility can calculate the difference between charge and discharge prices (minus efficiency losses) to figure the avoided cost of procuring that energy at peak hours from a grid-scale generator (SCE White Paper, 2010, pp. 46-47). As with price arbitrage for renewables grid integration, multiple factors might affect the economic viability of this value stream, making it an uncertain source of income in mid and long-term planning.

DESS may be able to find more certain value by offering dependable operating capacity for eventual participation in the RA process. SCE terms this function “distribution-level RA deliverability” (SCE White Paper, 2010, p. 46). As with renewables grid integration, this option is not available under current baseline RA rules. However this report considers it an option for accelerated deployment.

5.3.4.2 Community Energy Storage: Accelerated Characteristics

Activities at the CPUC relating to distributed generation can be geared toward ensuring that increasing amounts of variable distributed generation have a net positive impact on the performance of the distribution grid. This goal might require consideration of DESS for inclusion in customer-side incentive programs, as well as in the context of any revised interconnection standards that come out of the CPUC's Renewable Distributed Energy Collaborative working group.

In addition, the CPUC's development of a valuation methodology (or more, depending on the application) for energy storage pursuant to the AB 2514 rulemaking should include tools to measure the value of distribution-level DESS based on location and grid characteristics. This methodology in turn depends upon a transparent process for valuing distribution upgrade deferral benefits and avoided costs for variable distributed generation integration. In its smart grid deployment plan, SDG&E suggests that accurate price signals are necessary to encourage desired consumer behaviors. For example, by assigning the cost borne by the utility of "storing" consumer-generated renewable energy to those consumers participating in residential net-energy metering, these consumers might then decide to invest in energy storage coupled to their systems (San Diego Gas and Electric, 2011b, pp.28-29).

As with other applications for energy storage, accelerated deployment of DESS would benefit from a change in RA regulations such that the utility can count investments in or procurement of dispatchable DESS toward its RA obligations. Finally, targets promulgated under AB 2514, if any, can be used to accelerate deployment specifically of DESS by linking procurement targets to identified needs, such as distribution deferral, peak shaving, and distribution-level frequency regulation, for which the optimal storage resource would be located closer to load. Without further research into the benefits and costs of DESS for these purposes, the CPUC may not be able to determine viability and cost effectiveness of any targets in accordance with AB 2514.

5.3.5 Community Energy Storage: Benefits and Costs

As with grid integration of VER, there is insufficient information available on variable distributed generation resources, the likely extent and rate of penetration, and the anticipated effects on the grid and benefits and costs of utilizing energy storage to assist with integration. This assessment reviews the known or presumed benefits and costs of DESS, installed on the utility side of the meter, in the context of pending or possible regulatory and market changes.

5.3.5.1 Benefits of Energy Storage for Community Energy Storage

As discussed above, community energy storage may provide numerous benefits to the local grid and may mitigate complications associated with increased amounts of variable distributed generation – both customer-side and utility-side. Recent energy storage cost-benefit analyses

classify distributed energy storage differently but identify many overlapping benefits. Depending on the location and applications for the DESS, specific benefits may include improved power quality and reliability, distribution upgrade deferral, distribution-level outage mitigation, variable distributed generation integration, area regulation or ancillary services, and local reserve capacity. The EPRI, Sandia National Laboratories, and SCE valuation efforts focus on the following DESS uses and benefits:

Table 12: DESS Uses and Benefits

	Application	Description	Potential Benefits
EPRI	Distributed Energy Storage Systems - commercial or residential	Centrally managed modular system (on utility side of the meter)	Increased customer reliability; voltage support; grid support/ distribution deferral; reduce distribution losses; possible ancillary services.
Sandia National Laboratories	Locational Distributed Storage Applications	Applications best served or only served by storage that is distributed where needed/ close to load	Voltage support; transmission congestion relief & distribution upgrade deferral; electric service reliability & power quality; distributed renewables integration/ capacity firming
	Non-Locational Distributed Storage Applications	Applications that may be served by distributed storage, located anywhere that its operation does not cause technical problems for the grid	Electric energy time-shift; electric supply capacity; load following; area regulation; reserve capacity; renewables energy time-shift
Southern California Edison	Primary distribution level peak shaving and outage mitigation	Transportable storage located downstream of an outage or overload; provides power to end-users during short-term distribution overload	RA and dependable operating capacity; energy shifting/ price arbitrage; outage mitigation; avoid transmission-level dump energy/ curtailment; distribution upgrade deferral; power quality; end-user backup power
	Peak shaving below "secondary"	Storage located downstream of	RA and dependable operating capacity; energy shifting/

	distribution system level	secondary distribution system to alter end-user load shape by charging off-peak and discharging at peak	price arbitrage; distribution upgrade deferral; avoid transmission-level dump energy/ curtailment; local/ in-basin generation; transmission congestion fee avoidance; power quality; outage mitigation
	Intermittent “DG” output smoothing and integration	Storage located between distributed generation sources and the distribution system; devices charges when generation exceeds power consumption	Variable distributed generation integration/ minimize backflow of energy onto the grid; avoid energy dumping; local/ in-basin generation; variable resource smoothing & shaping; power quality; outage mitigation

(Eyer, 2010, pp.56-59; EPRI, 2010a, pp.2-7, Table 2-4 and 3-10 to 3-12; SCE White Paper, 2010, pp. 45-54)

As the penetration of variable distributed generation, especially photovoltaic, increases, the challenges associated with managing voltage and intermittent variation in loads are expected to increase. For variable distributed generation “output smoothing” and integration, the DESS can be located to minimize or avoid potential “backflow” of unused or excess energy from the generation site onto the grid. A small percentage of energy backflow at a given time may not be problematic. However, unmitigated backflow from increased variable distributed generation may overstress circuits, requiring upgrades or causing outages (See SCE White Paper, 2010, pp.22-23). In addition, sudden momentary drops in output from distributed generation can increase variable energy integration costs. Carefully sited DESS have the potential to avoid line upgrades at the point that will provide the most value to the system, serving both to smooth output and to absorb and store backflow. Another potentially compatible benefit is the avoidance of transmission congestion fees, where the DESS store and release energy to reduce demand downstream of a congested transmission area (Eyer, 2010, p.57).

According to EPRI, many of these benefits will have value where solar generation is concentrated on the distribution system, but the value is difficult to quantify as alternative strategies for managing concentrated photovoltaics are still being developed (Electric Power Research Institute, 2010a, p. 3-19). Researchers struggle to quantify other benefits. For example, the cost value of outage mitigation and backup power are based on the individual circumstances of the affected end-users, while electric energy shifting depends upon highly variable wholesale prices and possibly diminishing price spreads. (See SCE White Paper, 2010, pp.46-47; Eyer, 2010, p.66). Still other applications, such as the use of transportable storage for

distribution level peak shaving, offer the benefits of avoided generation procurement and distribution deferral – both of which require valuation that considers what would be the generation and/or distribution upgrade needs of the particular location for the deployment of DESS.

5.3.5.2 Potential Cost Implications of Energy Storage for Community Energy Storage

The cost effectiveness of utility side of the meter DESS will vary based on the needs of the location and distribution area served, including the value to the end users of electric power quality and reliability and the avoided cost values attached to distribution upgrade deferral and avoided generation procurement for variable distributed generation integration. Sandia and EPRI provided present value estimates for key DESS benefits, including voltage support and distribution upgrade deferral, renewables integration avoided cost, and price arbitrage. Alone, these benefit values are slight compared to the technology and operating costs. But when aggregated across several categories, DESS may possess economically viable value propositions.

EPRI illustrated this aggregation value with an example of stationary T and D support – an example which could work similarly for transportable or modular storage for DESS applications. In the California ISO market, the aggregated value of such services as deferred transmission investment, system capacity, and voltage support amounted to less than \$500/kWh of present value of energy storage. However, when the same system was modeled to serve regulation in the ancillary services market and potentially defer transmission investments (which would most likely occur by co-locating energy storage and renewable generation), the value more than doubled (Electric Power Research Institute, 2010a, pp. 2-8 – 2-9). EPRI cautions that the locations in which all of these benefits can be realized together are limited, as is the market size of the higher-value value propositions. Even so, the modular configuration of DESS allows them to be sited to maximize the services and benefits that can be aggregated. The range of those services is broader than what central or bulk storage could address (Eyer, 2010, p.56), suggesting that proper planning and assessment of location and compatible applications could create opportunities for cost-effective DESS deployment.

For example, the use of transportable storage for DESS applications may increase the value over time. Sandia provides an example of a transportable storage device that, over the course of 10 years, is used either for T and D upgrade deferral or to serve electric service power quality and reliability needs. Based on Sandia's present value estimate for both of those applications, a modular DESS that could be owned and operated for less than \$1,700/kW for 10 years could be cost effective (Eyer, 2010, p.129).

SCE's analysis of distributed energy storage applications found that several hold promise and may even be hypothetically cost effective for limited niche applications.⁵⁸ For intermittent distributed generation "output smoothing" and integration, SCE modeled a 500 kW, 15-minute Li-Ion battery, such as could be installed to balance a 1 MW photovoltaic system.⁵⁹ The SCE report stated, "Initial valuations could in fact be cost effective at current technology costs (see figure 14 and Appendix A for additional information). However, in the near term (next few years), large DG sites requiring costly infrastructure upgrades will be passed over for those which do not. In other words, given the current availability of suitable sites, DG deployments will naturally gravitate first towards projects which will not require distribution upgrades. While a potentially promising use of storage, at best SCE believes actual deployments will be limited to extremely specific projects which do not currently exist but might in the future" (SCE White Paper, 2010, pp.53-54).

For peak shaving below the secondary distribution system level, SCE again modeled a Li-Ion battery, noting that commercially available sodium-sulfur batteries are too large (in capacity and physical size) for the application. To be cost effective, a 25 KW, 4-hour, high-energy Li-Ion battery would require technology costs to fall by 50 percent, T and D deferral costs to increase by 10 percent, and market rents from arbitrage to increase by 50 percent. SCE found these figures to be promising based on anticipated technology cost reductions and assumptions that developers could meet certain operational practices (SCE White Paper, 2010, p.51). Moreover, extending the location for this DESS further "downstream," closer to the customer or end user, can increase distribution deferral value. By contrast, SCE found that a transportable, 2MW, 4-hour Li-Ion battery used for primary distribution level peak shaving and outage mitigation did not carry the same cost-effective potential based on technology costs and the difficulty of evaluating distribution-level benefits without location-specific field trials (Ibid., pp.48-49).

5.3.6 Milestones and Next Steps for Community Energy Storage

As with Section 5.1.6 and 5.2.6 above, this section suggests goals for PIER research, funding, focus, and collaboration with industry and the CPUC and/or California ISO. It also identifies certain milestones for policymakers at the CPUC and the Energy Commission to consider.

⁵⁸ For a detailed list of the assumptions that underlie SCE's cost effectiveness conclusions, see SCE, 2010a, Appendix A, pp. 71-74.

⁵⁹ This is an example of DESS tied to a particular end-use, and most likely installed on the customer side of the meter, rather than utility-side. Nonetheless, it demonstrates the cost effective potential of DESS and could be extrapolated to apply to a utility-side system sited to serve a neighborhood or community.

5.3.6.1 Milestones and Next Steps for Community Energy Storage

Critical upcoming research and technology milestones for policymakers to consider include the following:

- IOU filing of Smart Grid plans,
- Final results of the California ISO 33percent renewables integration study,
- Implementation of legislation to extend SGIP funding for energy storage with the potential to finance standalone and solar-coupled energy storage systems (AB 1150 [V. Manuel Pérez, Chapter 310, Statutes of 2011]),
- Data from California-based ARRA grid storage demonstration projects,
- Implementation of TOU/dynamic rates under the smart grid legislation timeline, and
- California meeting the CSI and distributed generation goals.

5.3.6.2 Next Steps

The Energy Commission's PIER program could focus on the following activities related to community energy storage:

- PIER funding for research into communication technologies that enable participation and lower cost of participation by non-utility and end user owners with grid connected energy storage technologies. This research should seek to understand the integration implications of high-density solar PV areas on the distribution and transmission grid. It should also determine a value for DESS in conjunction with PHEV/EV charging stations that rely on variable renewable resources. The study should contemplate second use of PHEV/EV batteries for modular DESS short duration applications. Finally, it could assess the impact on the cost effectiveness of DESS if it is based on second use technology, including an accounting of the societal and environmental benefits.
- PIER should work with the CPUC to develop a valuation methodology for DESS, both utility-side and end-user-side.
- PIER should partner with IOUs and public utilities to fund and support smart grid plans that use distributed generation and energy storage, especially with utility devices for communication and scheduling.
- PIER should work with distribution system owners to develop additional research projects, as needed.

CHAPTER 6: 2020 Energy Storage Vision and Recommendations

The AB 2514 process presents California with an opportunity to be a leader in incorporating energy storage technologies to address vital grid needs and environmental and energy goals. This concluding section seeks to inform policymakers at the CPUC and Energy Commission as they help determine the role that energy storage can play in the state's electricity system and offers a vision for how energy storage can address pressing grid needs in 2020. With myriad technologies and applications at issue, coupled with the fast pace of technology developments and the changing nature of the state's electricity generation portfolio, few subjects are as far-reaching and volatile as the future of energy storage in the electricity system.

6.1 Energy Storage Vision for 2020

As policy makers anticipate future grid needs and how energy storage can address them, they should consider a number of key developments that are likely to transpire between now and 2020 that will influence the role of energy storage. Given the technology and policy factors examined in this report, this section identifies the following key developments as critical determinants in envisioning optimal energy storage deployment by 2020.

6.1.1 33 percent or More Renewable Energy Generation Under the 2020 Renewables Portfolio Standard

The California Renewable Energy Resources Act (Senate Bill 2, Simitian), signed by Governor Brown into law in April 2011, requires California to procure 33percent of its electricity from renewable sources by 2020. However, integrating these variable and intermittent sources, such as solar and wind, will require an array of policy mechanisms. Increased energy efficiency, demand response, aggregating variable resources across large areas, forced or paid curtailment of the renewable sources, increased deployment of fossil fuel-based generators, such as natural gas-fired turbines, and the emerging Smart Grid, can help meet the integration challenge. However, energy storage offers a beneficial option to integrate this variable energy without additional greenhouse gas emissions, while providing other services for the grid, such as peak load shaving and back-up power in the event of blackouts. While policy makers should explore all cost-effective options, given California's environmental and greenhouse gas goals and need to avoid curtailment of renewable resources, California may require between 3,000 to 4,000 megawatts of fast-acting energy storage by 2020 to integrate the projected increase in renewable energy. Studies by KEMA and the National Renewable Energy Laboratory, among others, provide support for this estimate, which could increase or decrease by 2020, depending on a number of policy and technology developments.

6.1.2 Implementation of the Smart Grid

The deployment of “Smart Grid” systems in California may enhance the market for customer-side of the meter energy storage systems. The Smart Grid concept is based on actively managing resources and loads by taking advantage of real-time data monitoring, analysis, and control enabled by digital sensor, information, and communication networks. The current power grid is designed to have generation sources respond on-demand to user needs, while a smart grid can be designed so that usage varies on-demand with production availability from intermittent power sources such as wind and solar. The utility can actively shed end-user loads during peak usage periods, or the cost per kilowatt can dynamically vary between peak and non-peak periods to encourage turning off non-essential high power loads.

The emergence of a “smarter grid” may both improve and lessen the need for energy storage. Because utilities may be able to reduce end-user load with the new, smarter technology, they may not require energy storage to shave peak load or maximize the efficiency of renewable energy electricity production. However, as customers, particularly from the business and industrial sectors, access real-time pricing information and identification of periods of peak electricity rates, they may consider purchasing on-site distributed energy storage systems, particularly batteries, to avoid peak charges. These purchases will in turn drive down costs for the technologies both due to economies of scale with greater production and the potential to spur innovations that make the technologies more efficient.

In addition, residential and business consumers can use the smart grid to increase their purchases of thermal energy storage technologies for heating, ventilation, and air conditioning (HVAC) systems. Utilities can also coordinate and aggregate these systems on the utility-side of the meter, resulting in expanded markets for thermal energy storage technologies. Closely related to demand response technologies, these systems have the potential to accommodate intermittent renewable generation and reduce peak load.

California will benefit in 2020 from federal investments in smart grid demonstration projects and the associated energy storage projects involved in these efforts. The American Recovery and Reinvestment Act invested \$685 million in smart grid and energy storage demonstration projects, laying a foundation for utilities and industry to partner with the government and enable the real-world testing and development necessary for energy storage to gain ground. These projects should yield important data on cost and performance to spur further research, investment, and deployment by 2020.

6.1.3 Proliferation of Microgrids

A new manifestation of a utility-based Smart Grid is the emergence a rapidly growing market of “microgrids” for industrial/commercial-type customers that require extremely high reliability

and availability of electricity supply. Leading examples of microgrids include military bases, data centers, some manufacturing processes, universities, flight control centers, and governmental facilities. The military represents the largest growth customers for microgrids, given their energy mandates from legislation and executive order to make dramatic improvements to their installations' resiliency and endurance as a military force.

Electric energy storage is a mandatory element in the design and architecture of a microgrid that does not rely on fossil fueled electricity generation. Energy storage is central to achieving the higher reliability and availability of energy supply, as well as maintaining the power quality on distribution circuits. As with military applications, only energy storage can prevent a loss of access to power, provide efficient access to alternative and renewable energy sources available to the installation, and offer adequate and resilient power for critical missions.

In essence, microgrids are a recent microcosm of larger-scale Smart Grid (transmission and distribution) utility in the digital energy age. They are likely to become more common by 2020. Because microgrids represent early adopters of electricity energy storage by necessity and its high value, their deployment will be an excellent tool to evaluate new and emerging distributed energy storage technologies and to address their integration issues, particularly as the Smart Grid continues to deploy at utility scale. Thus, greater micro-grid deployment in California will lead to better data and a more robust market for energy storage technologies.

6.1.4 Increased Residential Needs for On-Site Solar, Electric Vehicles, and Home Area Networks

The proliferation of residential PV systems and the potential large-scale deployment of electric vehicles (as well as an increase in zero net energy buildings) have the capacity to fundamentally change the market for energy storage in 2020. Customers can potentially use behind-the-meter energy storage systems, particularly batteries, to capture and balance electricity from on-site renewables. They may also be able to use their battery systems to participate in power markets by providing grid services when not in use. However, most residential customers will still need to access electricity from utilities as backup or supplemental power. Barring technological advances, this application may ultimately be more effective for commercial customers to offset high demand charges while still relying generally on grid-supplied power.

The deployment of electric vehicles (EV) may create other opportunities for energy storage. Large-scale adoption of EVs will likely drive down battery costs for lithium ion batteries as manufacturers increase production to meet demand. Engineers are developing fast charging systems, referred to as "Level 3," to recharge EVs in a matter of minutes rather than hours.

The delivery of so much electrical power in a short period of time could stress the local distribution network, so the addition of energy storage between the grid and Level 3 chargers

could provide needed buffering.

In addition, vehicle owners in 2020 and sooner may be able to sell or otherwise recycle used batteries for second-use applications, such as providing distributed storage opportunities for the grid. Meanwhile, vehicle owners may be able use their batteries in “vehicle-to-grid” applications that, when plugged in to specially designed bi-directional charging systems, could offer ancillary services to utilities, such as frequency regulation. The utilities could compensate them for these services, providing vehicle owners with a revenue stream from their EVs. Vehicle-to-grid research is ongoing to understand the impacts of these services on battery life and how consumer behavior may affect the potential for this application.

6.1.5 Opening of Electricity Markets to Competition From Energy Storage and Incentive Programs

The opening of various electricity markets to energy storage competition through Federal Energy Regulatory Commission (FERC) and the California Independent System Operator (Cal ISO) rulings will likely spur greater deployment of these technologies that can compete better in a less restrictive market. For example, current markets for regulation services often disfavor fast-acting energy storage technologies, such as flywheels, that could otherwise provide competitive services with fossil fuel-based providers. Energy storage will also play increasing roles in providing other operational and market benefits for the grid, such as congestion management, oscillation mitigation, and infrastructure/asset management for optimal utilization, among others. As market rules change to allow the monetization of the benefits provided by specific energy storage technologies, investors and developers will fund more projects and thereby help decrease the costs and provide more data on performance.

In addition, regulatory entities like FERC and the California Public Utilities Commission can provide greater certainty of cost recovery for investments in energy storage technologies by ensuring that these asset investments have greater certainty of cost recovery and by developing a valuation methodology to help monetize the benefits provided by energy storage. Additional changes, such as allowing more energy storage technologies to participate in the Resource Adequacy program, would provide utilities with incentives to procure more energy storage capacity. These regulatory changes will likely stimulate greater investment and deployment of energy storage across the grid.

Complementing these regulatory initiatives, the state and federal governments may develop incentive programs, through new programs or the expansion of existing ones, to help finance energy storage projects. From federal loan guarantees and funding for demonstration programs to expansion of the self-generating incentive program, these measures will likely bring down costs and help manufacturers provide better data to spur further investment by 2020.

6.1.6 Natural and Human-Caused Disasters

Disasters over the next decade may spur greater investment in energy storage. Possible scenarios range from costly blackouts that jeopardize business functions and perishable goods storage to nuclear meltdowns, earthquakes, terrorist attacks, and other catastrophes. One of the results of these disasters could be regulations that require on-site backup energy storage to provide uninterrupted and continuous electricity and to help the grid restart as quickly as possible, among other benefits.

6.1.7 Likely Price Decreases for Various Energy Storage Technologies

The result of the potential increase in investment and deployment of energy storage technologies, in turn driven by the aforementioned policy changes and technological advances that may occur over the next decade, means that California and the nation will experience potentially significant price drops in the cost of various energy storage technologies by 2020. For example, the proliferation of electric vehicles may drive down battery costs, while market rules that allow greater penetration of flywheels for specific grid applications may drive down costs and increase deployment. Increased penetration of renewables will likely increase the need to balance the intermittent load with non-carbon based fuel sources, spurring a market for up-and-coming technologies like those related to batteries. In addition, advances in existing technologies, such as creative siting for pumped hydro facilities in abandoned mine shafts, may eliminate barriers that could lead to wider adoption.

While not all technologies will benefit from economies of scale and will still require technological advancements to lower costs and ensure performance, California will likely experience cost benefits from the coming grid developments, while the technologies will also benefit from increased investment that could spur the necessary technological innovation. In addition, demonstration projects will provide critical data and certainty and could provide more assurance to investors.

The likely competitor for energy storage over the next decade may be inexpensive natural gas. However, natural gas prices are not likely to stay at current prices and may increase by 2020, leading to greater market opportunities for energy storage. In addition, the ability of energy storage technologies to harness and dispatch carbon-free renewable energy will become more important as the state implements carbon pricing and other legal and regulatory mechanisms to reach its ambitious greenhouse gas reduction goals. As a result, by 2020, the need for energy storage will be significantly greater than today.

6.1.8 Future Research Needs to Implement the Vision

To meet the challenges and vision outlined in this section, this report cites a number of technical and policy research needs that the state should undertake to help implement the vision of

energy storage in 2020. These needs include:

- Bulk energy storage demonstrations for variable renewable energy integration (for example pumped hydro, CAES, and solar thermal).
- Field demonstration of modular energy storage technologies (for example batteries, flywheels) in various grid applications.
- Evaluation/demonstration of aggregated storage, for example TES HVAC or electric vehicle (EV) batteries, especially in a Smart Grid scenario.
- Develop simulations, analytical tools, and intelligent control systems for planning, designing and dispatching energy storage devices for multiple applications and benefits.
- Quantification of costs and benefits of energy storage in grid applications.
- Models of the impact of 33percent renewable energy on California's electricity grid to determine needs for energy storage to support the grid, including sensitivity analysis to address cost variables of storage and other needed energy resources, environmental impacts, and emerging Smart Grid performance enhancements.
- A valuation methodology for energy storage that accounts for its costs and benefits to ratepayers and the public, given the state's energy and environmental goals. This method could value technologies based on the most promising applications, ensuring that benefits to additional applications are appropriately counted. This report identifies three potentially promising applications for energy storage: frequency regulation, integrating variable renewable energy, and developing community or distributed energy storage systems. In addition, the methodology could analyze how the location of the energy storage technologies may change the value of the resource. The data would help determine whether policy should encourage co-locating energy storage with generation assets.
- Research into communication technologies that enable participation and lower cost of participation by non-utility and end-user owners with grid connected energy storage technologies. This research should seek to understand the integration implications of high-density solar PV areas on the distribution and transmission grid. It should also determine a value for distributed energy storage systems in conjunction with PHEV/EV charging stations that rely on variable renewable resources. The study should contemplate second use of PHEV/EV batteries for modular distributed energy storage systems short duration applications. Finally, it could assess the impact on the cost effectiveness of DESS if it is based on second-use technology, including an accounting of the societal and environmental benefits.
- Studies on how energy storage could operate in conjunction with demand response technologies. Can energy storage increase the value, responsiveness, and accuracy of

demand response? Can energy storage increase the value by making participation in demand response programs more palatable to end users with specific electricity needs?

- Studies to review the impacts of recent tariff changes at NY-ISO, ISO-NE, PJM, and other grid operators on energy storage technologies attempting to compete in the area and frequency regulation market. In particular, the study could examine the impact of the NY-ISO's "fast first" scheduling and ISO-NE's "mileage payment" under its pilot program and consideration of combining mileage payment with performance based pricing.
- Studies to review the technical requirements and cost implications of intra-hour and shorter scheduling at California ISO in connection with regional balancing. Shorter scheduling may be necessary to justify tariff changes that would compensate providers for speed and accuracy.
- Research into the potential impacts of utilizing energy storage for needed regulation over existing fossil fuel-based power plants. This effort could include a cost study on new, fast, and efficient natural gas plants and how these options compare for integrating renewables versus energy storage devices.

By undertaking these research projects, the California Energy Commission and other entities can help the state prepare for the future needs that energy storage technologies can help address.

6.2 Policy Drivers for Energy Storage Deployment

The CPUC and the Energy Commission should consider developing and implementing policies to eliminate barriers to energy storage deployment that prevent cost-effective deployment.

6.2.1 CPUC and AB 2514 Target Potential

The setting of energy storage targets engenders significant controversy. The state's investor-owned utilities oppose any targets for energy storage, believing that such targets may result in increased costs for ratepayers and the selection of energy storage technologies that may not be as cost effective as competing solutions. They also cite the need for more pilot and demonstration projects to provide additional data and certainty regarding investments in energy storage. These and other stakeholders fear that the setting of targets may cannibalize options that may be more cost effective and promising, such as automated demand response technologies.

Conversely, proponents of energy storage targets believe that only a strong mandate from the state will overcome the inertia and resistance to adopting energy storage technologies. These proponents cite a complex and overlapping regulatory structure that serves to disfavor energy storage technologies that would provide critical benefits for the state that are not currently

monetized under this system. In addition, they cite institutional barriers at the regulatory agencies and utilities that make energy storage less competitive compared to traditional assets. A broad mandate, based on an assessment of the grid needs that energy storage could meet, could force changes on this byzantine system at a faster rate than the business-as-usual scenario.

Regardless of the merits of each side, the CPUC has a legislative mandate to evaluate the feasibility and effectiveness of setting energy storage targets, if any. Should the agency decide to set these targets, this report seeks to inform how such targets might function. As a general recommendation, the CPUC should look to other proceedings for guidance on target setting. For example, several proceedings have taken a two-tier or two-track approach to goal setting, which may provide an example for energy storage target structuring under AB 2514. The CPUC should consider a two-track target with a more ambitious, shorter-term target, possibly based on or informed by applications that have already proven to be cost effective and suitable to energy storage, and a longer-term target, oriented toward applications that only can be cost effective with certain emerging technologies that require substantial new R and D or time for data collection. Examples of this approach include the permanent load shifting study referenced in Chapter 2 that recommends near-term and longer-term targets based on technology stage. In addition, the California ISO *Renewable Integration: Market and Product Review* phases are broken into near-term and longer-term solutions. The key to these solutions is the link to the market design changes being considered in California ISO phase 2 and the potential positive impacts on the cost effectiveness of affected energy storage technologies. These design changes include pay-for-performance regulation, load-following reserve requirement, a methodology to allocate the costs of integrating increased amounts of variable renewable energy resources, and modifications to intra-day market settlements.

A two (or more) track approach could also function well with application-based targets, in which the CPUC 1) makes necessary changes to remove barriers to competition for the procurement of energy storage under a variety of business models and 2) selects a valuation methodology that allows LSEs to procure cost-effective resources for system need. To jumpstart the valuation process, the CPUC should engage early with the authors of existing cost-benefit and valuation studies (such as EPRI, Sandia, and SCE) and other stakeholders to begin the valuation phase of the AB 2514 proceeding as soon as possible, if not concurrently with the ongoing first stage. In addition, since AB 2514 emphasizes the environmental benefits of energy storage (such as through reduced greenhouse gas emissions and reduced peak power plant reliance), the CPUC should consider a determination of cost effectiveness under the statute as including the value of various societal and environmental benefits. Inclusion of these factors could alter the cost effectiveness conclusions, given that none of the studies cited in this report quantified those benefits.

6.2.2 Additional Policies for Energy Storage Deployment

These steps could include adding energy storage to the loading order as a preferred resource over fossil fuel (potentially depending on their specific application), allowing energy storage technologies to participate in the RA program, providing long-term contract capability (especially for capacity-based applications but possibly for regulation, which would require cooperation from California ISO over current scheduling practices), encouraging tariff changes at California ISO and FERC, and continuing R and D funding and demonstration projects.

In addition, as discussed in Chapter 2, policymakers should consider allowing energy storage technologies to play a larger role in transmission planning, congestion mitigation, and serve as an alternative or deferral option to transmission upgrades. FERC may need to classify energy storage as a transmission asset to help resolve this issue. If FERC decides against allowing energy storage to qualify as a transmission asset, transportable or modular energy storage and DESS on the distribution grid may serve a similar function that could be monetized.

Finally, policymakers should be aware of the important role that federal tax credits have played in stimulating renewable energy development. These incentives should be renewed with the potential for expansion to energy storage through federal legislation. Overall, continued R and D investment in energy storage is important to lower technology costs and to better inform decision-makers about the future of various technologies.

6.2.3 Agency Coordination

Various agencies involved in the electricity system should ensure they are engaged in ongoing collaboration to coordinate energy storage policies. The Energy Commission, through the IEPR, can recommend ways that California energy agencies can work together toward common goals. Stakeholders providing comments to this report have repeatedly indicated that agencies occasionally work at cross-purposes, stunting opportunity for growth and progress in the energy storage field. To the extent this sentiment is accurate, agencies should therefore collaborate to align market design and policy changes to the direction set forth in the 2011 IEPR. For example, if the IEPR concludes that low-high peak differentials and price volatility increases the opportunity for participation from non-generating technologies in the market, then deployment of energy storage, implementation of dynamic pricing, regulations for EV charging, and other relevant policies should align to that goal.

6.3 Conclusion

The subject of energy storage involves numerous technologies, applications, regulatory entities, and grid processes. Given the state’s long-term goals for integrating variable renewable energy into the grid and decreasing greenhouse gas emissions, policy makers must determine how energy storage can best fit with these future grid needs. These leaders should begin by identifying the critical grid needs that energy storage technologies could address, developing a method for valuing the various energy storage technologies in these applications, and evaluating the policy options available to them to increase deployment of energy storage where the technologies, market value, and locational and environmental benefits offer the most value compared to the alternatives. With this framework, policy makers can determine how California can achieve an appropriate and cost-effective deployment of energy storage that meets all of the state’s energy and environmental goals.

GLOSSARY

AA	Advanced Adiabatic
AFC	Alkaline Fuel Cells
ARB	California Air Resources Board
ARPA-E	Energy Advanced Research Projects Agency
ARRA	American Recovery And Reinvestment Act
BASE	Beta-Alumina Solid Electrolyte
CAES	Compressed Air Energy Storage
CCSE	California Center For Sustainable Energy
CESA	California Energy Storage Alliance
CPUC	California Public Utilities Commission
CSI	California Solar Initiative
CREB	Clean Renewable Energy Bond
CLPS	Closed Loop Pumped Storage Projects
CSP	Concentrating Solar Power
DENA	German Energy Agency
DESS	Distributed Energy Storage Systems
DOE	Department Of Energy
EDLC	Electric Double-Layer Capacitor
EPRI	Electric Power Research Institute
ERCOT	Electric Reliability Council Of Texas
EES	Electrochemical Energy Storage
EAP	Energy Action Plans
FERC	Federal Energy Regulatory Commission
FES	Flywheel Energy Storage

GE	General Electric
GHG	Green House Gasses
GIP	Generator Interconnection Procedures
GPM	Gravity Power Moduletm
HVAC	Heating, Ventilation, And Air Conditioning
HTF	Heat-Transfer Fluid
HTS	High Temperature Superconductor
ISO	Independent System Operator
IEPR	Integrated Energy Policy Report
IOU	Investor Owned Utilities
ITC	Investment Tax Credit:
LADWP	Los Angeles Dep't Of Power And Water
LESR	Limited Energy Storage Resource
LSE	Load-Serving Entities
LTPP	Long Term Procurement Planning
LEV	Low Emission Vehicle
MISO	Midwest ISO
METI	Ministry Of Economy, Trade And Industry (Japan)
MCFC	Molten Carbonate Fuel Cells
NREL	National Renewable Energy Laboratory
NEDO	New Energy And Industrial Technology Development Organization (Japan)
NOPR	Notice Of Proposed Rulemaking
O and M	Operating And Maintenance
OIR	Order Instituting Rulemaking
OEM	Original Equipment Manufacturer
P G and E	Pacific Gas And Electric Company
PNNL	Pacific Northwest National Laboratory
PIRP	Participating Intermittent Renewables Program
PLS	Permanent Load Shifting
PAFC	Phosphoric Acid Fuel Cells
PJM	Pjm Interconnection
PHEV	Plug-In Hybrid Electric Vehicle
PEM	Polymer Electrolyte Membrane
PPA	Power Purchase Agreements
PTC	Production Tax Credit
POU	Publicly Owned Utilities
PV	Photovoltaic
QECB	Qualified Energy Conservation Bond
QF	Qualifying Facilities

RA	Resource Adequacy
R and D	Research And Development
RAES	Regenerative Air Energy Storage
REM	Regulation Energy Management
RPS	Renewable Portfolio Standard
RA	Resource Adequacy
SMUD	Sacramento Municipal Utilities District
S D G and E	San Diego Gas And Electric Co.
SGIP	Self Generation Incentive Program
STRC	Societal Total Resource Cost
SOFC	Solid Oxide Fuel Cells
SCE	Southern California Edison
SMB	Superconducting Magnetic Bearings
T and D	Transmission And Distribution
TES	Thermal Energy Storage
TMO	Transition Metal Oxides
TOU	Time Of Use
TRC	Total Resource Cost
UPS	Uninterruptible Power Supply
VER	Variable Energy Resources
WECC	Western Electricity Coordinating Council
ZEV	Zero Emission Vehicle

REFERENCES

- Abraham, K.M., Z. Jiang. 1996. "A Polymer Electrolyte-Based Rechargeable Lithium/Oxygen Battery." *Journal of the Electrochemical Society*, 1996: 1-5.
- AES Energy Storage. 2011. "ERCOT Energy Storage Registration/Testing Issues." *Presented at ERCOT Emerging Technologies Working Group Meeting*. January 2011.
http://www.ercot.com/content/meetings/etwg/keydocs/2011/0105/AES_ES_ERCOT_Storage_Registration_and_Testing.pdf.
- American Recovery and Reinvestment Act of 2009. Pub. Law 115-5. 123 Stat. 115 at 345-47. February 17, 2009.
- Armand, M., J.M. Tarascon. 2008. "Building Better Batteries." *Nature*, 2008: 652-657.
- Assembly Bill 2514 (Skinner, Chapter 469, Statutes of 2010).
- Assembly Bill 1150 (V. Manuel Pérez, Chapter 310, Statutes of 2011).
- Assembly Bill 32 (Núñez, Chapter 488, Statutes of 2006).
- Australian Department of the Environment, Water, Heritage and the Arts. 2009. *Smart Grid, Smart City: A New Direction for a New Energy Era*.
<http://www.ret.gov.au/energy/Documents/smart-grid/smartgrid-newdirection.pdf>.
- Australian Department of Resources, Energy and Tourism, Advanced Electricity Storage Program.
http://www.ret.gov.au/energy/clean/cei/advanced_electricity_storage_technologies_program/Pages/AdvancedElectricityStorageTechnologies.aspx.
- Ballard Power Systems, Inc. "CLEARgen™ Specification Sheet." SPC5103076-0B.
- Ballard Power Systems Inc. 2009. "Notice of Annual Meeting, Management Proxy Circular and 2009 Annual Report."
- Ballard Power Systems, Inc. 2011. "Smarter Solutions for a Clean Energy Future." March 8, 2011.
- Beacon Power. <http://www.beaconpower.com/> (accessed: March 2011).
- Beck, F., P. Rüetschi. 2000. "Rechargeable Batteries with Aqueous Electrolytes." *Electrochimica Acta*, 2000.
- Bitterly JG. 1998. Flywheel technology. *IEEE Aerospace and Electronic Systems Magazine*.

Buena, C. and J.A. Cartab. 2006. "Wind Powered Pumped Hydro Storage System: A Means of Increasing the Penetration of Renewable Energy in the Canary Islands." *Renewable and Sustainable Energy Reviews*, 10: 312–340.

Boeing Phantom Works: DOE Energy Storage Program, 2004 Peer Review.

Bolund, B., H. Bernhoff, M. Leijon. 2007. "Flywheel energy and power storage systems." *Renewable and Sustainable Energy Reviews* 11: 235-258.

Bullough, C. 2004. "AA-CAES: Integration of Wind Energy." Alstom Power Technology Centre, United Kingdom.

Bullough, C., Gatzen, C., Jakiel, C., Koller, M., Nowi, A., Zunft, S. 2004. "Advanced Adiabatic Compressed Air Energy Storage for the Integration of Wind Energy." *Proceedings of the European Wind Energy Conference*. London, United Kingdom.

California Energy Storage Alliance. 2010. *Comments of the California Energy Storage Alliance to Order Instituting Rulemaking Pursuant to AB 2514 to Consider the Adoption of Procurement Targets for Viable and Cost-Effective Energy Storage Systems*. January 21, 2010. Appendix A.

http://www.storagealliance.org/workfilings/2011-01-21-CESA_Storage_Scoping_Ruling_Opening_Comments_FINAL.pdf.

California Air Resources Board. 2008. *Climate Change Scoping Plan: a Framework for Change*. December 2008.

California Air Resources Board. 2009. *White Paper: Summary of Staff's Preliminary Assessment of the Need for Revisions to the Zero Emission Vehicle Regulation*. November 25, 2009.

<http://www.arb.ca.gov/msprog/zevprog/2009zevreview/zevwhitepaper.pdf>.

California Air Resources Board. 2010a. *Proposed Regulation for California Renewable Electricity Standard: Initial Statement of Reasons*. June 2010.

California Air Resources Board. 2010b. *Staff Report: Initial Statement of Reasons, Proposed Regulation to Implement the California Cap-and-Trade Program, Part I, Vol. I*. October 28, 2010.

California Air Resources Board. 2010c. "ZEV Regulation Workshop." Sacramento, California. May 3, 2010. http://www.arb.ca.gov/msprog/zevprog/2011zevreg/05_03_10pres.pdf.

California Council on Science and Technology. 2011. *California's Energy Future: the View to 2050*. Summary Report. May 2011.

California Energy Commission, Public Utilities Commission. 2005. *Energy Action Plan II*. September 21, 2005.

California Energy Commission. 2005a. *Implementing California's Loading Order for Electricity Resources*. Staff Report. July 2005.

California Energy Commission, Public Utilities Commission. 2008. *2008 Energy Action Plan Update*. February 2008.

California Energy Commission. 2009. *2009 Integrated Energy Policy Report*. CEC-100-2009-003-CMF. December 2009.

California Energy Commission. 2010a. *2010 Integrated Energy Policy Report Update*. CEC-100-2001-001-CMF. January 2011.

California Energy Commission. 2010b. *Solar Thermal Projects Under Review or Announced*. <http://www.energy.ca.gov/siting/solar/index.html> (accessed May 15, 2011).

California Energy Commission. 2010c. *Energy Commission Awards \$2 Million to PG&E for Battery Storage Research*. February 9, 2010. http://www.energy.ca.gov/releases/2010_releases/2010-02-09_battery_storage.html.

California Energy Commission. 2011a. *2011 Integrated Energy Policy Report Scoping Order*. Docket # 11-IEP-1. August 31, 2010.

California Energy Commission. 2011b. *Transcript: IEPR Committee Workshop on Energy Storage for Renewable Integration*. http://www.energy.ca.gov/2011_energypolicy/documents/2011-04-28_workshop/2011-04-28_Transcript.pdf.

California Environmental Protection Agency, Air Resources Board, Energy Commission, Public Utilities Commission, California Independent System Operator. 2006. *California's Clean Energy Future – Collaborative Vision for 2020*. September 27, 2006.

California Independent System Operator. 2006. *PIRP FAQs – Part 1*. July 26, 2006. <http://www.caiso.com/17d0/17d0c24717130.html>.

California Independent System Operator. 2009. *2012-2014 Local Capacity Technical Analysis: Report and Study Results*. December 31, 2009. <http://www.caiso.com/2495/2495c63b23450.pdf>.

California Independent System Operator. 2010a. *Discussion Paper, Renewable Integration: Market and Product Review*. July 8, 2010.

California Independent System Operator. 2010b. *Attachment B, Non Generator Resources; Fourth Replacement California ISO Tariff*. May 18, 2010.

California Independent System Operator. 2010c. *Revised Draft Final Proposal for Participation of Non-Generator Resources in California ISO Ancillary Services Markets*. March 8, 2010.

California Independent System Operator. 2010d. *Smart Grid Roadmap: IS-1 ISO Uses Energy Storage for Grid Operations and Control*. November 12, 2010.

California Independent System Operator. 2011a. "Summary of Preliminary Results of 33percent Renewable Integration Study." *Presentation for the 2010 CPUC Long Term Procurement Planning*. Docket R-10-05-006. May 10, 2011. <http://www.caiso.com/2b73/2b73796015b90.pdf>.

California Independent System Operator. 2011b. *Revised Straw Proposal, Renewable Integration: Market and Product Phase 1*. February 17, 2011. <http://www.caiso.com/2b27/2b27e9ea6d680.pdf>.

California Independent System Operator. 2011c. *Discussion & Scoping Paper on Renewable Integration Phase 2*. April 5, 2011. <http://www.caiso.com/2b3d/2b3da2e92470.html>.

California Independent System Operator, Board of Governors. 2011d. *Decision on Regulation Energy Management*. February 3, 2011. <http://www.caiso.com/2b1a/2b1acd6d20610.pdf>.

California Independent System Operator. 2011e. *Regulation Energy Management Draft Final Proposal*. January 13, 2011.

California Independent System Operator. 2011f. *Draft Final Proposal: Generator Interconnection Procedures Phase 2*. May 27, 2011. <http://www.caiso.com/2b8b/2b8be21d30d90.pdf>.

California Independent System Operator. 2011g. "Economic Planning Study." *Presented at 2011/2012 ISO Transmission Plan Stakeholder Meeting of Unified Planning Assumptions and Study Plan*. April 7, 2011. Folsom, CA. <http://www.caiso.com/2b57/2b57e58541f30.pdf>.

California Independent System Operator. 2011h. "33 percent High Load Case – Preliminary New Scenarios: Monthly Regulation and Load Following Requirements – High Load Case." April 5, 2011. <http://www.caiso.com/23bb/23bbc01d7bd0.html>.

California Public Utilities Commission. Docket R10-12-007. <http://docs.cpuc.ca.gov/published/proceedings/R1012007.htm>.

California Public Utilities Commission - (a). "Distributed Generation in California." <http://www.cpuc.ca.gov/PUC/energy/DistGen/>.

California Public Utilities Commission – (b). "Renewable Distributed Energy Collaborative (Re-DEC)." <http://www.cpuc.ca.gov/PUC/energy/Renewables/Re-DEC.htm>.

California Public Utilities Commission – (c). “About the California Solar Initiative.”
<http://www.cpuc.ca.gov/PUC/energy/Solar/aboutsolar.htm>.

California Public Utilities Commission – (d). “CSI Program Application for Other Solar Technologies.” <http://www.cpuc.ca.gov/PUC/energy/Solar/othersolar.htm>.

California Public Utilities Commission. 2008. *Decision Addressing Eligible Technologies Under the Self-Generation Incentive Program (SGIP) and Modifying the Process for Evaluating SGIP Program Change Requests*. November 24, 2008.

California Public Utilities Commission. 2009a. *RPS Quarterly Report (Q4 2009)*.

California Public Utilities Commission. 2009b. *Order Instituting Rulemaking to Consider Alternative-fueled Vehicle Tariffs, Infrastructure and Policies to Support California’s Greenhouse Gas Emissions Reduction Goals*. August 20, 2009.

California Public Utilities Commission. 2009c. *Decision Adopting Demand Response Activities and Budgets for 2009 through 2011*. D09-08-027. August 20, 2009.
http://docs.cpuc.ca.gov/word_pdf/FINAL_DECISION/106008.pdf.

California Public Utilities Commission. 2010a. *Order Instituting Rulemaking Pursuant to AB 2514 to Consider Adoption of Procurement Targets for Viable and Cost-Effective Energy Storage Systems*. December 16, 2010.

California Public Utilities Commission. 2010b. *Proposed Decision of Comm’r Ryan, Decision Adopting Requirements for Smart Grid Deployment Plans Pursuant to Senate Bill 17 (Padilla, Chapter 327, Statutes of 2009)*. July 24, 2010.

California Public Utilities Commission. 2010c. *Attachment 1: 2010 Demand Response Cost Effectiveness Protocols*. Docket R07-01-041. December 16, 2010.

California Public Utilities Commission. 2010d. *Electric Energy Storage: an Assessment of Potential Barriers and Opportunities*. July 9, 2010.

California Public Utilities Commission. 2011a. “Progress Toward California’s Renewables Portfolio Standard Goals,” *Presented at Senate Oversight Hearing*. February 1, 2011.
http://www.cpuc.ca.gov/NR/rdonlyres/B5320B26-82A8-45EB-AD27-266FD4C09FF2/0/PresentationforOversightHearings_RPS_2111CPUC.pdf

California Public Utilities Commission. 2011b. *Scoping Memo and Assigned Ruling of Commissioner and Administrative Law Judge*. Docket R10-12-007. May 31, 2011.

California Public Utilities Commission. 2011c. *2010 Long-Term Procurement Plan System Analysis Preliminary Results*. Docket R10-05-006. May 9, 2011.

http://www.cpuc.ca.gov/NR/rdonlyres/DC4E126B-B8D0-41C5-9CB5-081CCF98689E/0/LTPP_Apr29_Filing_E3_final_5911.pdf.

California Public Utilities Commission. 2011d. *2010 Long-Term Procurement Plan System Analysis Preliminary Results*. Docket R10-05-006. May 9, 2011.

http://www.cpuc.ca.gov/NR/rdonlyres/DC4E126B-B8D0-41C5-9CB5-081CCF98689E/0/LTPP_Apr29_Filing_E3_final_5911.pdf.

Carta, J.A., J. Gonzalez, V. Subiela. 2003. "Operational analysis of an innovative wind powered reverse osmosis system installed in the Canary Islands." *Solar Energy* 75(2):153–168.

Cavallo, A. 2007. "Controllable and affordable utility-scale electricity from intermittent wind resources and compressed air energy storage (CAES)." *Energy* 32. pp. 120-127.

Chen, H., T.N. Cong, W. Yang, C. Tan, et al. 2009. "Progress in Electrical Energy Storage System: a Critical Review." *Progress in Natural Science*. March 2009.

China Energy Storage Alliance. 2011. *Industry Trends Newsletter*. April 2011.

<http://www.chinaenergystorage.org/do/bencandy.php?fid=57&id=311>.

City of Los Angeles. 2010. *Increasing Reliable Renewable Energy in Los Angeles*. September 13, 2010, http://mayor.lacity.org/PressRoom/PressReleases/LACITYP_011469.

Consumer Power and Conservation Financing Authority, Public Utilities Commission, Energy Resources Conservation and Development Commission. 2003. *Energy Action Plan*. May 8, 2003.

Customized Energy Solutions. 2009. "Electric Energy Storage Technologies in ERCOT." *Presented at the ERCOT Renewables Technology Working Group*. December 7, 2009.

<http://www.ercot.com/content/meetings/rtwg/keydocs/2009/20091207-RTWG/Walawalkar-EnergyStorage-ERCOT-RTWG-12-2009.pdf>.

Cutter, Eric, et al. 2009. "Impact of Market Rules on Energy Storage Economics." *Energy and Environmental Economics*.

Dell, R.M. and D.A.J. Rand, "Clean Energy," Cambridge : Royal Society of Chemistry, c2004. ISBN 0-85404-546-5 (p. 187 - 191).

Demachi, K., K. Miya, R. Takahata, et al. 2002. "Numerical evaluation of rotation speed degradation of superconducting magnetic bearing caused by the electromagnetic phenomena," *Physica C* 378–381: 858–863.

Denholm, P., et al. 2010. *The Role of Energy Storage with Renewable Electricity Generation*. National Renewable Energy Laboratory. Technical Report NREL/TP-682-47187. January 2010.

DeTeresa SJ. *Materials for advanced flywheel energy storage devices*. MRS Bull 1999.

Division of Ratepayer Advocates. 2011. "Comments of the Division of Ratepayer Advocates on Order Instituting Rulemaking Pursuant to Assembly Bill 2514." California Public Utilities Commission. January 21, 2011. <http://docs.cpuc.ca.gov/published/proceedings/R1012007.htm>.

Douche, M.L., F. Novel-Cattin, R. Durand, J.J. Rameau. 1997. "Characterization of Different Grades of Aluminum Anodes for Aluminum/Air Batteries." *Journal of Power Sources*, 1997: 197-205.

ECN abstract. 1994. *Large Hydrogen Underground Storage*. http://www.ika.rwth-aachen.de/r2h/index.php/Large_Hydrogen_Underground_Storage.

Edison International. 2010. *Southern California Edison Finalizes Stimulus Grant to Start Large-Scale Energy Storage Demonstration*. October 20, 2010. <http://www.edison.com/pressroom/pr.asp?id=7482>.

Electric Power Research Institute. 2010a. *Electrical Energy Storage Technology Options: A White Paper Primer on Applications, Costs and Benefits*. EPRI. Palo Alto, CA 1020676.

Electric Power Research Institute. 2010b. *Functional Requirements for Electric Energy Storage Applications on the Power System Grid*. Palo Alto, California: 1020075.

Electric Power Research Institute and Southern California Edison. 2010. *Smart Grid Demonstration Initiative*. http://www.smartgrid.epri.com/doc/EPRI%20Smart%20Grid%20Demonstration%202010%20Update_final.pdf (accessed August 3, 2011).

Electric Reliability Council of Texas (ERCOT). 2010. *Emerging Technologies Integration Plan Quarterly Update for the Period Ending December 31, 2010*. http://www.ercot.com/content/meetings/tac/keydocs/2011/0303/11._ETIP_Quarterly_Report-4th_Quarter2010_Final_Revised_III_.doc.

Electric Reliability Council of Texas (ERCOT). 2011. *ERCOT Wholesale Market Subcommittee, Meeting Minutes*. February 8, 9, 2011. http://www.ercot.com/content/meetings/wms/keydocs/2010/0922/approved_minutes_wms_100922.doc.

Electricity Storage Association (ESA).

http://www.electricitystorage.org/ESA/technologies/pumped_hydro/ (accessed April 2011).

Ellis, J. 2011. "Re: Docket #11-IEP-1N, Questions for Panelists at the April 28, 2011 Workshop," *Comments to the April 28, 2011 IEPR Workshop*. April 26, 2011.

http://www.energy.ca.gov/2011_energypolicy/documents/2011-04-28_workshop/comments/Jack_Ellis_Comments_Energy_Storage.pdf.

Energy and Environmental Economics, Inc. and Straten Consulting. 2010. *Statewide Joint IOU Study of Permanent Load Shifting*. December 1, 2010.

Energy Independence and Security Act of 2007 (42 U.S.C. Sec. 17001, et seq.).

Executive Office of the President, National Science and Technology Council. 2011. *A Policy Framework for the 21st Century Grid: Enabling Our Secure Energy Future*. June 13, 2011.

Executive Order No. S-14-08. November 17, 2008.

Executive Order No. S-21-09. September 15, 2009.

Eyer, J. 2009. *Electric Utility Transmission and Distribution Upgrade Deferral Benefits from Modular Electricity Storage*. Sandia National Laboratories for U.S. Department of Energy. June 2009.

Eyer, J., G. Corey. 2010. *Energy Storage for the Electricity Grid: Benefits and Market Potential Assessment Guide*. Sandia National Laboratories for U.S. Department of Energy. SAND2010-0815. February 2010.

Federal Energy Regulatory Commission. Docket AD10-13.

http://elibrary.ferc.gov/idmws/docket_sheet.asp.

Federal Energy Regulatory Commission. 2007. *FERC Order 890*. 72 FR ¶ 12,266. May 15, 2007.

Federal Energy Regulatory Commission. 2008a. *FERC Order 719*. 125 FERC ¶ 61, 071 (issued October 17, 2008).

Federal Energy Regulatory Commission. 2008b. *Order on Compliance*. 125 FERC ¶ 61, 319 (issued December 18, 2008).

Federal Energy Regulatory Commission. 2009. *Order Accepting Tariff Revisions*. 127 FERC ¶ 61, 135 (issued May 15, 2009).

Federal Energy Regulatory Commission. 2010. *Request for Comments Regarding Rates, Accounting, and Financial Reporting for New Electric Storage Technologies*. 75 FR 122, 36381. June 25, 2010.

- Federal Energy Regulatory Commission. 2011. "Frequency Regulation Compensation in the Organized Wholesale Power Markets," 134 FERC ¶ 61, 124. February 17, 2011.
- Fertig, E. , S. Wagner. 2010. *The Role of Energy Storage in Renewable Power Integration*. Integration and Policy Workshop for RenewElec Project. Carnegie Mellon University. October 21-22, 2010.
- Finkenrath, M., Pazzi, S., D'Ercole, M., Marquardt, R., Moser, P., Klafki, M., Zunft, S. 2009. "Status and Technical Challenges of Advanced Compressed Air Energy Storage (CAES) Technology." *International Workshop on Environment and Alternative Energy*. Munich, Germany.
- Fioravanti, R., J. Enslin. 2007. *Emissions Comparison for a 20 MW Flywheel-based Frequency Regulation Power Plant*. KEMA-Inc. May 18, 2007.
- Florida Solar Energy Center. 2007. *Hydrogen Basics – Production*.
- Fthenakis, V. 2008. *Compressed Air Energy Storage (CAES) Scoping Workshop: Enabling Solar and Wind Energy Technologies on a Grand Scale*.
- Fujiwara, N., M. Yao, Z. Siroma, H. Senoh, et al. 2011. "Reversible air electrodes integrated with an anion-exchange membrane for secondary air batteries." *Journal of Power Sources*, 196: 808-813.
- Gabrys CW. 2001. *High Performance Composite Flywheel*. US patent Pub. No.: US 2001/0054856 A1. December 27, 2001.
- General Electric. 2010. *GE Durathon Batteries*. May 5, 2010 (accessed May 4, 2011).
- Genta G. 1985. *Kinetic energy storage: theory and practice of advanced flywheel systems*. London, Butterworths.
- Germany Energy Agency (DENA). 2010. *DENA Grid Study II, Integration of Renewable Energy Sources into the German Power Supply System from 2015-2020 with Outlook to 2025*. November 2010. http://www.dena.de/fileadmin/user_upload/Download/Dokumente/Studien___Umfragen/dena_Grid_Study_II_-_final_report.pdf.
- Germany Federal Ministry of Economics and Technology, Federal Ministry for the Environment, Nature Conservation, and Nuclear Safety. 2010. *Energy Concept for an Environmentally Sound, Reliable, and Affordable Energy Supply*. September 28, 2010. <http://www.bmwi.de/English/Redaktion/Pdf/energy-concept,property=pdf,bereich=bmwi,sprache=en,rwb=true.pdf>.
- Gordes, J. N., A. L. Weisbrich, D. L. Rainey, P. W. Olson. 2000. "Offshore WARP Wind Power and Integral H₂—Gas Turbines or Fuel Cells." *Proceedings of the European Seminar on Offshore*

Wind Energy in Mediterranean and Other European Seas (OWEMES) Conference. Syracuse, Sicily, Italy. April 2000.

Greenblatt, J. B., Succar, S., Denkenberger, D. C., Williams, R. H., Socolow, R. H. 2007. "Baseload wind energy: modeling the competition between gas turbines and compressed air energy storage for supplemental generation." *Energy* 35. pp. 1474-1492.

Gunther, Erich. 2009. "Ice Bear Energy Storage System – 90 out of 100." *Smart Grid News.com*. February 2, 2009.

http://www.smartgridnews.com/artman/publish/reviews/Ice_Bear_Energy_Storage_System_90_out_of_100.html.

Gyuk, I., S. Eckroad. 2003. *EPRI-DOE Handbook of Energy Storage for Transmission and Distribution Applications*. Electric Power Research Institute and U.S. Department of Energy.

Hassenzahl, W.V. 2001. *IEEE Trans. Appl. Supercond.* 11: 1653.

HDR Engineering, Inc. 2010. *Hydroelectric Pumped Storage for Enabling Variable Energy Resources within the Federal Columbia River Power System*. Prepared for Bonneville Power Administration. September 30, 2010

Huggins, R.A., 2010. *Energy Storage*. Springer-Verlag GmbH. July 2010.

Hydrogenics. HySTAT™ Hydrogen Station, Rev 1004.

Ibrahim, H., A. Ilinca, and J. Perron, "Energy storage systems—Characteristics and comparisons," *Renewable and Sustainable Energy Reviews* (2008), Volume: 12, Issue: 5, Publisher: Elsevier, Pages: 1221-1250.

Internal Revenue Code, Section 45. 26 U.S.C. Sec. 45.

Internal Revenue Code, Section 48. 26 U.S.C. Sec. 48.

ISO New England, Inc. 2010. *Markets and Services Tariff, Appendix J, Alternative Technologies Regulation Pilot Program*. August 30, 2010.

Itron. 2010. *Impacts of Distributed Generation: Final Report*. Prepared for the California Public Utilities Commission. January 2010.

Itron. 2011. *Cost-Effectiveness of Distributed Generation Technologies*. February 9, 2011. http://www.cpuc.ca.gov/PUC/energy/DistGen/sgip/proposal_workshops.htm.

- Japan Ministry of Economy, Trade and Industry. 2010a. *The Strategic Energy Plan of Japan: Summary*. Revised June 2010. http://www.meti.go.jp/english/press/data/pdf/20100618_08a.pdf.
- Japan Ministry of Economy, Trade and Industry. 2010b. *Proposals for Next Generation Energy and Social System Demonstration Areas*. April 2010. <http://www.meti.go.jp/english/press/data/pdf/N-G%20System.pdf>.
- KEMA. 2007. *Energy Time-shift from Wind Generation Emissions Comparison for a 20 MW Flywheel-based Frequency Regulation Power Plant*. Beacon Power Corp. KEMA Project: BPCC.0003.001. January 8, 2007.
- KEMA, Inc. 2010. *Research Evaluation of Wind Generation, Solar Generation, and Storage Impact on the California Grid*. Prepared for the California Energy Commission. CEC-500-2010-010. June 2010.
- Kohari, Z., I. Vajda. 2005. "Losses of flywheel energy storages and joint operation with solar cells." *Journal of Materials Processing Technology* 161(1–2): 62–65.
- Koshizuka N., et al. 2002. "Present status of R&D on superconducting magnetic bearing technologies for flywheel energy storage system." *Physica C* 378-381: 11-17.
- Kristov, L. 2011. "Allocation of Integration Costs." California ISO. *Presented at the Renewable Integration Phase 2 Stakeholder Meeting*. April 12, 2011. Slides 25-29. <http://www.caiso.com/2b5a/2b5ae96271cf0.pdf>.
- Kruse, B., Grinna, S., Buch, C. 2002. *Hydrogen Status og Muligheter*. Bellona.
- LaCommare, K.H., J.H. Eto. 2004. *Understanding the Cost of Power Interruptions to U.S. Electricity Consumers*. Ernest Orlando Lawrence Berkeley National Laboratory. September 2004. <http://certs.lbl.gov/pdf/55718.pdf>.
- Largeot, C., C. Portet, J. Chmiola, P. Taberna, et al. 2008. "Relation Between Ion Size and Pore Size for an Electrical Double Layer Capacitor." *Journal of the American Chemical Society*, 130: 2730-2731.
- Lin, J., et al. 2011. *Energy Storage – a Cheaper, Faster & Cleaner Alternative to Conventional Frequency Regulation*. Strategen Consulting for the California Energy Storage Alliance. February 16, 2011.
- Lipman, T.E., R. Ramos, D.M. Kammen. 2005. *An Assessment of Battery and Hydrogen Energy Storage Systems Integrated with Wind Energy Resources in California*. California Energy Commission, PIER Research. CEC-500-2005-136. September 2005.

Liu, H., J. Jiang. 2007. "Flywheel energy storage—an upswing technology for sustainability." *Energy and Buildings* 39: 599-604.

Long, T., D. Narayan, et al. 2000. "Simulation of the interaction between flywheel energy storage and battery energy storage on the international space station." *Proceedings of the Intersociety Energy Conversion Engineering Conference*. Las Vegas, NV. July 2000. pp. 848–854.

MacKay, David J.C. 2007. *Enhancing Electrical Supply by Pumped Storage in Tidal Lagoons*. University of Cambridge. March 2007.

Makansi, J. 2005. "Energy Storage: Why so few pay attention and what we can do about it." *EESAT*. San Francisco, CA.

Makarov, Y.V., et al. 2008. *Assessing the Value of Regulation Resources Based on Their Time Response Characteristics*. Pacific Northwest National Laboratory. June 2008.

Marshal, J. 2009a. "PG&E Opts for Energy Storage." *NEXT100*. August 26, 2009.
<http://www.next100.com/2009/08/pge-opts-for-energy-storage.php>.

Marshal, J. 2009b. "PG&E's Big Battery." *NEXT100*. February 16, 2010.
<http://www.next100.com/2010/02/pges-big-battery.php>.

MWH. 2009. *Technical Analysis of Pumped Storage and Integration with Wind Power in the Pacific Northwest*. Prepared for U.S. Army Corps of Engineers, Northwest Division, Hydroelectric Design Center. August 2009.

Miller, M. 2011. "Modifications to Intra-Hour Scheduling & Other Market Design Enhancements," California Independent System Operator. April 12, 2011. pp. 21-24.
<http://www.caiso.com/2b5a/2b5ae96271cf0.pdf>.

Mulcahy, T.M., J.R. Hull, K.L. Uherka, R.G. Abboud, J.J. Juna. 2011. *IEEE Trans. Appl. Supercond* 11: 1729.

Nair, N.C., N. Garimella. 2010. "Battery energy storage systems: Assessment for small-scale renewable energy integration." *Energy and Buildings*. November 2010.

Nagaya, S., N. Kashima, M. Minami, H. Kawashima, S. Unisuga. 2001. *IEEE Trans. Appl. Supercond* 11: 1649.

Nakama, H. 2010. "NEDO Research Related to Large-scale PV-related Grid-connection Projects." New Energy and Industrial Technology Development Organization (NEDO).
http://www.sandia.gov/regis/presentations/H_Nakama-NEDO.pdf.

Nakhamkin, M. 2008. "Second Generation of the CAES Technology." *Compressed Air Energy Storage Scoping Workshop*. Columbia University.

Nakhamkin, M., Chiruvolu, M., Patel, M., Byrd, S., Schainker, R., Marean, J. 2009. "Second Generation of CAES Technology - Performance, Operations, Economics, Renewable Load Management, Green Energy." *Power-Gen International*. Las Vegas, NV.

Nakai, H., A. Matsuda, M. Suzuki. 2001. "Development and testing of the suspension system for a flywheel battery." *Control Engineering Practice* 9: 1039–1046.

National Renewable Energy Laboratory. *Parabolic Trough Thermal Energy Storage Technology*. http://www.nrel.gov/csp/troughnet/thermal_energy_storage.html (accessed June 20, 2011).

Neburchilov, V., H. Wang, J. Martin, W. Qu. 2010. "A Review on Air Cathodes for Zinc-Air Fuel Cells." *Journal of Power Sources*, 2010: 1271-1291.

New Energy and Industrial Technology Development Organization (NEDO). "Energy and Environmental Technology Projects." http://www.nedo.go.jp/english/activities_nedoprojects_energy.html#sb (accessed June 30, 2011).

New York Independent Service Operator. 2010. *Energy Storage in the New York Electricity Markets*. March 2010.

Nexight Group and Sandia National Laboratories. 2010a. "Advanced Materials and Devices for Stationary Electrical Energy Storage Applications." U.S. Department of Energy. December 2010.

Nexight Group and Sandia National Laboratories. 2010b. "Electric Power Industry Needs for Grid-Scale Storage Applications." U.S. Department of Energy. December 2010.

Nagaya, S., N. Kashima, M. Minami, H. Kawashima, S. Unisuga. 2001. *IEEE Trans. Appl. Supercond* 11: 1649.

NGK Insulators. *NaS Batteries*. <http://www.ngk.co.jp/english/products/power/nas/index.html> (accessed May 5, 2011).

Nguyen, T., R. Savinell. 2010. "Flow Batteries." *The Electrochemical Society Interface*. Fall 2010.

NYSERDA/DOE *Joint Energy Storage Initiative Demonstration Projects*. March 16, 2010. <http://www.storage-monitoring.com/nyserda-doe/storage-home.shtml> (accessed: March 2011).

Pacific Gas and Electric Company. 1997. *Thermal Energy Storage Strategies for Commercial HVAC Systems*.

Pdc Machines. "Diaphragm Compressors."

<http://www.pdcmachines.com/data/pdf/Compressors%20Formatted.pdf>.

Pieronek, Thomas, J., D. Decker, A.K. Spector Victor. 1997. "Spacecraft flywheel systems—benefits and issues, in: National Aerospace and Electronics Conference." *Proceedings of the IEEE*. Dayton, USA. July 1997. pp. 589–593.

PJM Interconnection, LLC. 2010a. *Alternative Technology Resource Pilot Program, Project Guidelines*. April 2010. Section 3.3.1.2. <http://www.pjm.com/~media/markets-ops/atr/atr-guidelines.ashx>.

PJM Interconnection, LLC. 2010b. *Regulation Market Incentive Payment: Problem Statement*. <http://www.pjm.com/~media/committees-groups/committees/mrc/20110119/20110119-item-05-regulation-market-performance-incentive-problem-statement-clean.ashx>.

PJM Interconnection, LLC. 2010c. *New Energy Storage Resource and Revised Station Power Definition*. July 6, 2010.

Popp, M. "Storage for secure power supply from wind and sun." www.poppware.de.

Assembly Bill 1150 (V. Manuel Pérez, Chapter 310, Statutes of 2011). Bill Analysis. http://www.leginfo.ca.gov/pub/11-12/bill/asm/ab_1101-1150/ab_1150_cfa_20110525_101450_asm_comm.html (accessed June 30, 2011).

Proton Energy Systems. HOGEN Hydrogen Generating Systems, H Series Hydrogen Generators Technical Specifications. PD-0600-0062 Rev. B, 01.09.

Public Utility Commission of Texas. 2011. *Report to the 82nd Texas Legislature: Scope of Competition in Electric Markets in Texas*. January 2011.

Purtz, J. 2010. *Submarine Adiabatic and Isobaric Compressed Air Energy Storage*.

Rawson, M. 2011. "Utilities' Perspective on Energy Storage." Sacramento Municipal Utility District. *Presented at California Energy Commission 2011 IEPR Workshop*. Sacramento, California. April 28, 2011. http://www.energy.ca.gov/2011_energypolicy/documents/2011-04-28_workshop/presentations/20_SMUD_Rawson_Panel_3.pdf.

Recovery.gov . "Grants-Award Summary – Pacific Gas & Electric." <http://www.recovery.gov/Transparency/RecipientReportedData/pages/RecipientProjectSummary508.aspx?AwardIdSur=75561&AwardType=Grants> (accessed May 9, 2011).

REN21. 2008. *Renewables 2007 Global Status Report*. Paris: REN21 Secretariat, and Washington, DC: Worldwatch Institute.

- Ries, G., H.W. Neumueller. 2001. "Comparison of energy storage in flywheels and SMES." *Physica C* 357–360: 1306–1310.
- Rittershausen, J., M. McDonagh. 2010. *Moving Energy Storage from Concept to Reality: Southern California Edison's Approach to Evaluating Energy Storage*. Southern California Edison.
- RWE. 2011. <http://www.rwe.com/web/cms/en/365478/rwe/innovations/power-generation/energy-storage/compressed-air-energy-storage/project-adele/>.
- RWE. 2010. *ADELE - Adiabatic Compressed-Air Energy Storage for Electricity Supply*.
- Sandia National Laboratories. *National Solar Thermal Test Facility*.
http://www.sandia.gov/Renewable_Energy/solarthermal/NSTTF/salt.htm (accessed April 2011).
- Sandia National Laboratories. 2010. *Energy Storage Systems Projects*. March 16, 2010.
<http://www.sandia.gov/ess/About/projects.html> (accessed: March 2011).
- San Diego Gas & Electric. 2010a. "Alan B. Marcher – Testimony on Electricity Distribution Capital Costs." *Application of SDG&E for authority to update its gas and electric revenue requirement and base rates effective on January 1, 2012*. December 2010. SDG&E Doc #249150.
- San Diego Gas & Electric. 2010b. "Lee. S Krevat – Testimony on Smart Grid Policy." *Application of SDG&E for authority to update its gas and electric revenue requirement and base rates effective on January 1, 2012*. December 2010. SDG&E Doc #249827.
- San Diego Gas & Electric. 2010c. "Kathleen H. Cordova – Testimony on Customer Services— Information." *Application of SDG&E for authority to update its gas and electric revenue requirement and base rates effective on January 1, 2012*. December 2010. SDG&E Doc #249538.
- San Diego Gas & Electric. 2010d. "Thomas Bialek – Testimony on Customer Services— Information." *Application of SDG&E for authority to update its gas and electric revenue requirement and base rates effective on January 1, 2012*. December 2010. SDG&E Doc #249440.
- San Diego Gas & Electric Co. 2011a. *SDG&E Proposes Adding 450MW of Local "Peaking" Power*. May 23, 2011.
http://public.sempra.com/newsreleases/viewpr.cfm?PR_ID=2607&Co_Short_Nm=SDGE.
- San Diego Gas & Electric. 2011b. *Smart Grid Deployment Plan, 2011-2020*. June 6, 2011.
<http://www.sdge.com/regulatory/A11-06-006.shtml>.
- Schiess, K. 2009. "TES Testimony." *Presented to California Public Utility Commission*.

Schiess, K. 2011. "Energy Storage for Renewable Integration: Comments to IEPR Workshop of April 28, 2011." *Comments to the April 28, 2011 IEPR Workshop*. KSEngineers.

http://www.energy.ca.gov/2011_energypolicy/documents/2011-04-28_workshop/comments/TN_60630_04-28-11_KSEngineers_Comments_on_the_April_28_2011_IEPR_Works.pdf.

Schoenung, S. 2011. "Economic Analysis of Large-Scale Hydrogen Storage for Renewable Utility Applications." *International Colloquium on Environmentally Preferred Advanced Power Generation*. Costa Mesa, California. February 8-10, 2011.

Schueneman, T. 2011. "Gravity Power Module Revolutionizes Pumped Hydro Energy Storage," *Triple Pundit*. March 11, 2011. <http://www.triplepundit.com/2011/03/gravity-power-module-aims-revolutionize-pumped-hydro-energy-storage/>.

Scrosati, B., J. Garche. 2010. "Lithium Batteries: Status Prospects and Future." *Journal of Power Sources*.

Senate Bill 2 (Simitian, Chapter 1, Statutes of 2011).

Senate Bill 107 (Simitian, Chapter 464, Statutes of 2006).

Senate Bill 17 (Padilla, Chapter 327, Statutes of 2009).

Sioshansi, R., P. Denholm. 2010. "The Value of Concentrating Solar Power and Thermal Energy Storage." National Renewable Energy Laboratory. NREL-TP-6A2-45833. February 2010.

Shakhtur, A. 2011. "GE Builds a High-Tech Fossil Fuel Power Plant for the Renewable Energy Age." *Fundamentalmente Energia*. May 29, 2011. <http://alishakhtur.com/2011/05/29/ge-builds-a-high-tech-fossil-fuel-power-plant-for-the-renewable-energy-age/>.

Siems, S.O., W.-R. Canders, H. Walter, J. Bock. 2004.. *Supercond. Sci. Technol.* 17: S229.

Simon, P., Y. Gogotsi. 2008. "Materials for Electrochemical Capacitors." *Nature Materials*, 2008: 845-854.

Southern California Edison. 2010a. "Generation-related Project Development Division (PDD) - Testimony of R. Harding and M. Nelson." *2012 General Rate Case, Vol. 10*. November 2010.

Southern California Edison. 2010b. "Generation-Catalina Operation and Maintenance (O&M) Expenses And Capital Expenditures - Testimony of R. Hite." *2012 General Rate Case, Vol. 11*. November 2010.

Southern California Edison. 2010c. "T&D Business Unit—Advanced Technology - Testimony of D. Kim." *2012 General Rate Case, Vol. 2*. November 2010.

Sparta Township, NJ. 2004. "Riverbank Project - Frequently Asked Questions". Sparta Township, NJ – Official Website. <http://www.spartanj.org/cit-e-access/webpage.cfm?TID=30&TPID=9809> (accessed June 20, 2011).

Statoil. "Atmospheric Electrolysers: 10 Nm³/h - 485Nm³/h." <http://www3.statoil.com/hydrogentechnologies/svg03816.nsf?OpenDatabase>.

Steward, D., Ramsden, T., Harrison, K. 2010. "Hydrogen for Energy Storage Analysis Overview." National Renewable Energy Laboratory. NREL/PR-560-48360. May 2010.

Swider, D. J. 2007. "Compressed Air Energy Storage in an Electricity System with Significant Wind Power Generation." *IEEE Transactions on Energy Conversion* 22(1): 95-102.

Texas Energy Storage Alliance. 2010. *Storage Participation in ERCOT*. January 3, 2010.

Texas Legislature Online. Proposed *Senate Bill 943 (Carona)*. <http://www.capitol.state.tx.us/BillLookup/History.aspx?LegSess=82R&Bill=SB943>.

Tobie, B., C. Liuchen, L. David. 2002. "A low speed flywheel system for wind energy conversion." Canadian Conference on Electrical and Computer Engineering. Winnipeg, Manitoba. May 2002. pp. 251–256.

Tzeng, J., R. Emerson, P. Moy. 2006. "Composite flywheels for energy storage." *Composites Science and Technology* 66: 2520-2527.

UC Berkeley Law, Center for Law, Energy & the Environment, and UCLA Law, Emmett Center on Climate Change and the Environment. 2010. *The Power of Energy Storage: How to Increase Deployment in California to Reduce Greenhouse Gases*. July 2010.

U.S. Department of Energy. 2009. *Annual Progress Report – Vehicle Technologies Program*. January 2009. http://www1.eere.energy.gov/vehiclesandfuels/pdfs/program/2008_energy_storage.pdf (accessed: March 2011).

U.S. Department of Energy. "Flywheel Energy Storage: an alternative to batteries for uninterruptible power supply systems." *Federal Technology Alert*. DOE/EE-0286.

U.S. Department of Energy. 2011a. *Quadrennial Technology Review Framing Document*. March 14, 2011. http://www.energy.gov/qtr/documents/DOE-QTR_Framing.pdf.

U.S. Department of Energy. 2011b. *Energy Storage Program Planning Document*. February 2011. http://www.oe.energy.gov/DocumentsandMedia/OE_Energy_Storage_Program_Plan_Febuary_2011v3.pdf.

U.S. Department of Energy, Electricity Advisory Committee. 2011c. *Energy Storage Activities in the United States Electricity Grid*. May 2011. http://www.oe.energy.gov/DocumentsandMedia/FINAL_DOE_Report-Storage_Activities_5-1-11.pdf.

U. S. Department of Energy, Office of Energy Efficiency & Renewable Energy. February 2011. http://www1.eere.energy.gov/hydrogenandfuelcells/fuelcells/fc_types.html#comparison.

U.S. Treasury Department. 2011. *Payments for Specified Energy Property in Lieu of Tax Credits Under the American Recovery and Reinvestment Act of 2009*. April 2011. [http://www.treasury.gov/initiatives/recovery/Documents/Guidance%203-29-11%20revised%20\(2\)%20clean.doc](http://www.treasury.gov/initiatives/recovery/Documents/Guidance%203-29-11%20revised%20(2)%20clean.doc).

Vit, B. M. Beatty Scott, B.J. DeBlonk, et al. 2004. "A review of technology developments in flywheel attitude control and energy transmission systems." *2004 IEEE Aerospace Conference Proceedings*. Big Sky, United States. March 2004. pp. 2784–2800.

Wagner, R. 2005. "High-Power Lead-Acid Batteries for Different Applications." *Journal of Power Sources*. June 2005.

Wagner, R.C., R. David Boyle, D. Kent. 2002. "Commercialization of flywheel energy storage technology on the international space station." *Proceedings of the Intersociety Energy Conversion Engineering Conference*. 37th Intersociety Energy Conversion Engineering Conference, IECEC. Washington, DC. July 2002. pp. 146–150.

Western Power Trading Forum. 2011. "Comments of the Western Power Trading Forum on Order Instituting Rulemaking Pursuant to AB 2514." January 21, 2011. <http://docs.cpuc.ca.gov/EFILE/CM/129824.htm>.

Woodbank Communications. *Battery Comparison Chart*. <http://www.mpoweruk.com/specifications/comparisons.pdf> (accessed April 22, 2011).

Woody, Todd. 2010. "In California's Mojave Desert, Solar-Thermal Projects Take Off." *Yale Environment* 360. October 27, 2010.

Yang, Z., J. Zhang, M. Kintner-Meyer, X. Lu, et al. 2010. "Electrochemical Energy Storage for Green Grid." *Chemical Reviews*. September 2010.

Yunicos. *The Island Test Bay: Autonomous Supply of Complete Island Grid From Renewable Energy Sources*. February 2009.

Zunft, S., Jakiel, C., Koller, M., and Bullough, C. 2006. "Adiabatic Compressed Air Energy Storage for the Grid Integration of Wind Power." *6th International Workshop on Large-Scale Integration of Wind Power and Transmission Networks for Offshore Windfarms*. Netherlands.